

EPA 625/1-81-013
(COE EM1110-1-501)

PROCESS DESIGN MANUAL
FOR
LAND TREATMENT OF
MUNICIPAL WASTEWATER

U. S. ENVIRONMENTAL PROTECTION AGENCY

U. S. ARMY CORPS OF ENGINEERS

U. S. DEPARTMENT OF INTERIOR

U. S. DEPARTMENT OF AGRICULTURE

October 1981

Published by

U. S. Environmental Protection Agency
Center for Environmental Research Information
Cincinnati, Ohio 45268

ACKNOWLEDGMENTS

I

This manual presents the state-of-the-art on process design for land treatment systems. It replaces the process design manual with the same title, published in October 1977. Preparation of this manual was sponsored by the U.S. Environmental Protection Agency (EPA), Office of Research and Development, and Office of Water; the U.S. Army Corps of Engineers; the U.S. Department of the Interior (USDI), Office of Water Research and Technology; and the U.S. Department of Agriculture (USDA), Office of Environmental Quality and Farmers Home Administration. An interagency coordinating committee representing these sponsors was established; this committee then selected a team of contract authors. Contract administration was provided by EPA CERL, Cincinnati, Ohio.

PROJECT OFFICER: Dr. James E. Smith Jr., EPA, CERL.

Dr. Smith was also chairman of the interagency coordinating committee. Assistance in contract administration was provided by Enviro Control, Inc., under the direction of Mr. Torsten Rothman.

CONTRACTOR: Metcalf & Eddy, Inc., Sacramento, California.

Supervision and Principal Authors:

Ronald W. Crites, Project Manager,
E.L. Meyer and R.G. Smith

Staff Authors:

M. Walker, K. Alston, M. Alpert, C. Stein

Editing and Review:

F. Burton, J. Miller, C. Pound

Consultant Authors:

Dr. A. Wallace, University of Idaho; Dr. W. Nutter, University of Georgia; Mr. D. Hinrichs, Culp/Wesner/Culp; Mr. B. Whitson, Mr. D. Deemer, Dr. O. Aly, and Mr. L. Gilde, Campbell Soup Company; Dr. E. Myers, Williams & Works, Inc.; Mr. D. Hirschbrunner and Ms. D. Parkes, Bruce Gilmore & Associates, Inc.

ACKNOWLEDGMENTS

II

A technical workgroup composed of members from the sponsoring agencies, as well as other invited experts, was formed. In addition, a multidisciplinary group of engineers and scientists also furnished technical review. Under the direction of its chairman, the workgroup defined the scope of the effort, supervised the work of the contractor, reviewed the manual, and provided technical editing and input to the manual.

CHAIRMAN: Sherwood C. Reed, USA CRREL

WORKGROUP:

EPA: Mr. R.E. Thomas, Dr. J.E. Smith Jr.,
Dr. C. Harlin, Mr. W. Whittington,
Mr. R. Bastian, Dr. H. Thacker,
Dr. N. Kowal, Mr. R. Dean, Mr. J. Ariail,
Dr. C. Enfield, Mr. J. Roesler,
Mr. W. Huang, Mr. J. Smith

U.S. Army: Mr. N. Urban, Mr. D. Lamont,
Mr. W. Medding, Mr. P. Carmichael,
Dr. I. Iskandar, Mr. J. Martel,
Mr. J. Bouzoun, Dr. R. Lee,
Mr. M. Cullinane, Mr. J. Bauer,
Dr. S. Schaub, Dr. H. McKim

USDA: Mr. P. Smith, Mr. C. Rose, Mr. G. Deal,
Dr. H. Bouwer, Mr. W. Opfer, Dr. D. Urie,
Mr. R. Phillips, Dr. D. Clapp

USDI: Mr. R. Madancy

USDOE: Ms. B. Broomfield

NSF: Dr. E. Bryan

Academic Institutions and State Agencies:

Dr. M. Kirkham, Dr. E. Lennette, Dr. W. Sopper,
Dr. R. Smith, Dr. A. Overman, Dr. R. Abernathy,
Dr. M. Overcash, Dr. A. Erickson, Mr. D. Kendrick

Invited Technical Reviewers:

Mr. B. Seabrook, Mr. T. Jenkins, Mr. J. Kreissl,
Mr. A. Palazzo, Dr. E. Smith, Ms. H. Farquhar,
Dr. R. Lewis, Dr. T. Asano, Mr. T. Rothman,
Mr. R. Sletten, Mr. G. Abele

ABSTRACT

This manual presents a rational procedure for the design of land treatment systems. Slow rate, rapid infiltration, and overland flow processes for the treatment of municipal wastewaters are discussed in detail, and the design concepts and criteria are presented. A two-phased planning approach to site investigation and selection is also presented.

The manual includes examples of each process design. Information on field investigations is presented along with special considerations for small scale systems. Equations and procedures are included to allow calculations of energy requirements for land treatment systems. Potential health and environmental effects and corresponding mitigation measures are discussed.

CONTENTS

Chapter		Page
	ACKNOWLEDGMENTS I	ii
	ACKNOWLEDGMENTS II	iii
	ABSTRACT	iv
	CONTENTS	v
	FIGURES	xv
	TABLES	xviii
1	INTRODUCTION AND PROCESS CAPABILITIES	
	1.1 Purpose	1-1
	1.2 Scope	1-1
	1.3 Treatment Processes	1-2
	1.4 Slow Rate Process	1-4
	1.4.1 Process Objectives	1-4
	1.4.2 Treatment Performance	1-8
	1.5 Rapid Infiltration	1-8
	1.5.1 Process Objectives	1-9
	1.5.2 Treatment Performance	1-11
	1.6 Overland Flow	1-11
	1.6.1 Process Objectives	1-13
	1.6.2 Treatment Performance	1-13
	1.7 Combination Systems	1-14
	1.8 Guide to Intended Use of the Manual	1-14
	1.9 References	1-17
2	PLANNING AND TECHNICAL ASSESSMENT	
	2.1 Planning Procedure	2-1
	2.2 Phase 1 Planning	2-1
	2.2.1 Preliminary Data	2-1
	2.2.2 Land Treatment System Suitability	2-9
	2.2.3 Land Area Requirements	2-16
	2.2.4 Site Identification	2-16
	2.2.5 Site Screening	2-22
	2.3 Phase 2 Planning	2-27
	2.3.1 Field Investigations	2-27
	2.3.2 Selection of Preliminary Design Criteria	2-27
	2.3.3 Evaluation of Alternatives	2-29
	2.3.4 Plan Selection	2-34
	2.4 Water Rights and Potential Water Rights Conflicts	2-34
	2.4.1 Natural Watercourses	2-35
	2.4.2 Surface Waters	2-37
	2.4.3 Percolating Waters (Ground Waters)	2-37
	2.4.4 Sources of Information	2-38
	2.5 References	2-38

CONTENTS (Continued)

Chapter		Page
3	FIELD INVESTIGATIONS	3-1
	3.1 Introduction	3-1
	3.2 Physical Properties	3-1
	3.2.1 Shallow Profile Evaluation	3-3
	3.2.2 Profile Evaluation to Greater Depths	3-4
	3.3 Hydraulic Properties	3-4
	3.3.1 Saturated Hydraulic Conductivity	3-5
	3.3.2 Infiltration Capacity	3-6
	3.3.3 Specific Yield	3-8
	3.3.4 Unsaturated Hydraulic Conductivity	3-8
	3.3.5 Profile Drainage	3-10
	3.4 Infiltration Rate Measurements	3-10
	3.4.1 Flooding Basin Techniques	3-13
	3.4.2 Cylinder Infiltrimeters	3-17
	3.4.3 Sprinkler Infiltrimeters	3-20
	3.5 Measurement of Vertical Hydraulic Conductivity	3-22
	3.5.1 Double-Tube Method	3-24
	3.5.2 Air Entry Permeameter	3-24
	3.6 Ground Water	3-27
	3.6.1 Depth/Hydrostatic Head	3-28
	3.6.2 Flow	3-30
	3.6.3 Ground Water Quality	3-36
	3.7 Soil Chemical Properties	3-36
	3.7.1 Interpretation of Soil Chemical Tests	3-37
	3.7.2 Phosphorus Adsorption Test	3-38
	3.8 References	3-39
4	SLOW RATE PROCESS DESIGN	
	4.1 Introduction	4-1
	4.2 Process Performance	4-1
	4.2.1 BOD and Suspended Solids Removal	4-1
	4.2.2 Nitrogen	4-3
	4.2.3 Phosphorus	4-5
	4.2.4 Trace Elements	4-7
	4.2.5 Microorganisms	4-7
	4.2.6 Trace Organics	4-10
	4.3 Crop Selection	4-11
	4.3.1 Guidelines for Crop Selection	4-11
	4.3.2 Crop Characteristics	4-15
	4.4 Preapplication Treatment	4-24
	4.4.1 Preapplication Treatment for Storage and During Storage	4-25
	4.4.2 Preapplication Treatment to Protect Distribution Systems	4-27

CONTENTS (Continued)

Chapter		Page
	4.4.3 Industrial Pretreatment	4-28
4.5	Loading Rates and Land Area Requirements	4-28
	4.5.1 Hydraulic Loading Rate Based on Soil Permeability	4-28
	4.5.2 Hydraulic Loading Rate Based on Nitrogen Limits	4-30
	4.5.3 Hydraulic Loading Rate Based on Irrigation Requirements	4-34
	4.5.4 Land Area Requirements	4-35
4.6	Storage Requirements	4-37
	4.6.1 Estimation of Volume Requirements Using Storage Water Balance Calculations	4-37
	4.6.2 Estimated Storage Volume Requirements Using Computer Programs	4-39
	4.6.3 Final Design Storage Volume Calculations	4-41
	4.6.4 Storage Pond Design Considerations	4-43
4.7	Distribution System	4-44
	4.7.1 Surface Distribution Systems	4-44
	4.7.2 Sprinkler Distribution Systems	4-45
	4.7.3 Service Life of Distribution System Components	4-53
4.8	Drainage and Runoff Control	4-53
	4.8.1 Subsurface Drainage Systems	4-53
	4.8.2 Surface Drainage and Runoff Control	4-56
4.9	System Management	4-58
	4.9.1 Soil Management	4-58
	4.9.2 Crop Management	4-61
4.10	System Monitoring	4-64
	4.10.1 Water Quality Monitoring	4-65
	4.10.2 Soils Monitoring	4-65
	4.10.3 Vegetation Monitoring	4-66
4.11	Facilities Design Guidance	4-66
4.12	References	4-68
5	RAPID INFILTRATION PROCESS DESIGN	
	5.1 Introduction	5-1
	5.1.1 RI Hydraulic Pathway	5-1
	5.1.2 Site Work	5-1
	5.2 Process Performance	5-3
	5.2.1 BOD and Suspended Solids	5-3
	5.2.2 Nitrogen	5-3
	5.2.3 Phosphorus	5-5
	5.2.4 Trace Elements	5-6
	5.2.5 Microorganisms	5-8
	5.2.6 Trace Organics	5-9

CONTENTS (Continued)

Chapter		Page
5.3	Determination of Preapplication Treatment Level	5-10
	5.3.1 EPA Guidance	5-10
	5.3.2 Water Quality Requirements and Treatment Goals	5-10
5.4	Determination of Hydraulic Loading Rate	5-12
	5.4.1 Measured Hydraulic Capacity	5-12
	5.4.2 Selection of Hydraulic Loading Cycle and Application Rate	5-14
	5.4.3 Other Considerations	5-17
5.5	Land Requirements	5-22
	5.5.1 Infiltration Basin Area	5-22
	5.5.2 Preapplication Treatment Facilities	5-22
	5.5.3 Other Land Requirements	5-22
5.6	Infiltration System Design	5-23
	5.6.1 Distribution and Basin Layout	5-23
	5.6.2 Storage and Flow Equalization	5-27
	5.6.3 Cold Weather Modifications	5-27
5.7	Drainage	5-28
	5.7.1 Subsurface Drainage to Surface Waters	5-28
	5.7.2 Ground Water Mounding	5-30
	5.7.3 Underdrains	5-38
	5.7.4 Wells	5-42
5.8	Monitoring and Maintenance Requirements	5-42
	5.8.1 Monitoring	5-42
	5.8.2 Maintenance	5-44
5.9	Design and Construction Guidance	5-45
5.10	References	5-46
6	OVERLAND FLOW PROCESS DESIGN	
6.1	Introduction	6-1
	6.1.1 Site Characteristics and Evaluation	6-1
	6.1.2 Water Quality Requirements	6-1
	6.1.3 Design and Operating Parameters	6-3
6.2	Process Performance	6-3
	6.2.1 BOD Removal	6-3
	6.2.2 Suspended Solids Removal	6-6
	6.2.3 Nitrogen Removal	6-6
	6.2.4 Phosphorus Removal	6-8
	6.2.5 Trace Element Removal	6-8
	6.2.6 Microorganism Removal	6-8
	6.2.7 Trace Organics Removal	6-9
	6.2.8 Effect of Rainfall	6-9

CONTENTS (Continued)

Chapter		Page
	6.2.9 Effect of Slope Grade	6-10
	6.2.10 Performance During Startup	6-10
6.3	Preapplication Treatment	6-10
6.4	Design Criteria Selection	6-11
	6.4.1 Hydraulic Loading Rate	6-12
	6.4.2 Application Rate	6-12
	6.4.3 Application Period	6-13
	6.4.4 Application Frequency	6-14
	6.4.5 Constituent Loading Rates	6-14
	6.4.6 Slope Length	6-14
	6.4.7 Slope Grade	6-15
	6.4.8 Land Requirements	6-15
6.5	Storage Requirements	6-18
	6.5.1 Storage Requirements for Cold Weather	6-18
	6.5.2 Storage for Stormwater Runoff	6-19
	6.5.3 Storage for Equalization	6-21
6.6	Distribution	6-22
	6.6.1 Surface Methods	6-22
	6.6.2 Low Pressure Sprays	6-24
	6.6.3 High Pressure Sprinklers	6-25
	6.6.4 Buried Versus Aboveground Systems	6-27
	6.6.5 Automation	6-27
6.7	Vegetative Cover	6-27
	6.7.1 Vegetative Cover Function	6-27
	6.7.2 Vegetative Cover Selection	6-28
6.8	Slope Construction	6-28
	6.8.1 System Layout	6-28
	6.8.2 Grading Operations	6-29
	6.8.3 Seeding and Crop Establishment	6-29
6.9	Runoff Collection	6-31
6.10	System Monitoring and Management	6-32
	6.10.1 Monitoring	6-32
	6.10.2 System Management	6-32
6.11	Alternative Design Methods	6-34
	6.11.1 CRREL Method	6-34
	6.11.2 University of California, Davis, (UCD) Method	6-36
	6.11.3 Comparison of Alternative Methods	6-38
6.12	References	6-39
7	SMALL SYSTEMS	
	7.1 Introduction	7-1
	7.2 Facility Planning	7-1
	7.2.1 Process Considerations	7-1
	7.2.2 Site Selection	7-5
	7.2.3 Site Investigations	7-8

CONTENTS (Continued)

Chapter		Page
7.3	Facility Design	7-9
	7.3.1 Preapplication Treatment and Storage	7-9
	7.3.2 Hydraulic Loading Rates	7-10
	7.3.3 Land Area Requirements	7-15
	7.3.4 Distribution Systems	7-16
7.4	Typical Small Community Systems	7-17
	7.4.1 Slow Rate Forage System	7-17
	7.4.2 Slow Rate Forest System	7-22
	7.4.3 Rapid Infiltration	7-26
	7.4.4 Overland Flow	7-30
7.5	References	7-31
8	ENERGY REQUIREMENTS AND CONSERVATION	
	8.1 Introduction	8-1
	8.2 Transmission Pumping	8-2
	8.3 General Process Energy Requirements	8-4
	8.3.1 Slow Rate	8-4
	8.3.2 Rapid Infiltration	8-4
	8.3.3 Overland Flow	8-5
	8.4 Energy Conservation	8-6
	8.4.1 Areas of Potential Energy Savings	8-6
	8.4.2 Example: Energy Savings in Slow Rate Design	8-8
	8.4.3 Summary	8-10
	8.5 Procedures for Energy Evaluations	8-10
	8.5.1 Slow Rate	8-11
	8.5.2 Rapid Infiltration	8-12
	8.5.3 Overland Flow	8-13
	8.5.4 Examples	8-13
	8.6 Equations for Energy Requirements	8-16
	8.6.1 Preapplication Treatment	8-17
	8.6.2 Land Treatment Processes	8-18
	8.7 References	8-18
9	HEALTH AND ENVIRONMENTAL EFFECTS	
	9.1 Introduction	9-1
	9.2 Nitrogen	9-3
	9.2.1 Crops	9-4
	9.2.2 Ground Water	9-4
	9.2.3 Surface Water	9-4
	9.3 Phosphorus	9-5
	9.3.1 Soils	9-5
	9.3.2 Crops	9-5
	9.3.3 Ground Water	9-5
	9.3.4 Surface Water	9-5

CONTENTS (Continued)

Chapter		Page
9.4	Dissolved Solids	9-5
	9.4.1 Soils	9-5
	9.4.2 Crops	9-6
	9.4.3 Ground Water	9-6
9.5	Trace Elements	9-8
	9.5.1 Soils	9-8
	9.5.2 Crops	9-9
	9.5.3 Ground Water	9-11
9.6	Microorganisms	9-12
	9.6.1 Soils	9-13
	9.6.2 Crops	9-14
	9.6.3 Ground Water	9-16
	9.6.4 Surface Water	9-16
	9.6.5 Aerosols	9-17
9.7	Trace Organics	9-21
	9.7.1 Soils	9-21
	9.7.2 Crops	9-22
	9.7.3 Ground Water	9-22
	9.7.4 Surface Water	9-23
9.8	References	9-24
Appendix		
A	SLOW RATE DESIGN EXAMPLE	
A.1	Introduction	A-1
A.2	Statement of Problem	A-1
	A.2.1 Background	A-1
	A.2.2 Population and Wastewater Characteristics	A-1
	A.2.3 Discharge Requirements	A-1
	A.2.4 Site Characteristics	A-2
	A.2.5 Climate	A-2
A.3	Slow Rate System Selection	A-4
	A.3.1 Preapplication Treatment	A-4
	A.3.2 Crop Selection	A-5
A.4	System Design	A-5
	A.4.1 Forage Crop Alternative	A-5
	A.4.2 Deciduous Forest Crop Alternative	A-22
	A.4.3 Selected SR Design	A-28
	A.4.4 Energy Requirements	A-28
B	RAPID INFILTRATION DESIGN EXAMPLE	
B.1	Introduction	B-1
B.2	Design Considerations	B-1
	B.2.1 Design Community	B-1
	B.2.2 Wastewater Quality and Quantity	B-1
	B.2.3 Existing Wastewater Treatment Facilities	B-2

CONTENTS (Continued)

Appendix		Page
	B.2.4 Climate	B-2
B.3	Site and Process Selection	B-3
B.4	Site Investigations	B-6
	B.4.1 Soil Characteristics	B-6
	B.4.2 Ground Water Characteristics	B-8
	B.4.3 Hydraulic Capacity	B-8
B.5	Determination of Wastewater Loading Rate	B-10
	B.5.1 Preapplication Treatment Level	B-10
	B.5.2 Hydraulic Loading Rate	B-10
	B.5.3 Hydraulic Loading Cycle	B-11
	B.5.4 Effect of Precipitation on Wastewater Loading Rate	B-11
	B.5.5 Underdrainage	B-11
	B.5.6 Nitrification	B-13
B.6	Land Requirements	B-13
	B.6.1 Preapplication Treatment Facilities	B-13
	B.6.2 Infiltration Basins	B-14
B.7	System Design	B-14
	B.7.1 General Requirements	B-14
	B.7.2 Underdrainage	B-18
B.8	Maintenance and Monitoring	B-18
	B.8.1 Maintenance	B-18
	B.8.2 Monitoring	B-20
B.9	System Costs	B-20
B.10	Energy Budget	B-20
B.11	References	B-22
C	OVERLAND FLOW DESIGN EXAMPLE	
	C.1 Introduction	C-1
	C.2 Statement of the Problem	C-1
	C.3 Design Considerations	C-1
	C.3.1 Wastewater Characteristics and Discharge Requirements	C-1
	C.3.2 Climate	C-2
C.4	Site Evaluation and Process Selection	C-2
	C.4.1 General Site Characteristics	C-2
	C.4.2 Soil Characteristics	C-4
	C.4.3 Process Selection	C-4
C.5	Distribution Method	C-4
C.6	Preapplication Treatment	C-4
C.7	Wastewater Storage	C-5
	C.7.1 Storage Requirement	C-5
	C.7.2 Storage Facility Description	C-5
C.8	Selection of Design Parameters	C-6
	C.8.1 Hydraulic Loading Rate	C-6
	C.8.2 Application Period and Frequency	C-6

CONTENTS (Continued)

Appendix	Page
C.8.3	Slope Length and Grade C-6
C.8.4	Application Rate C-7
C.8.5	Land Requirements C-7
C.9	Distribution System C-7
C.10	Preliminary System Layout C-9
C.11	System Design C-9
C.11.1	Treatment Slopes C-9
C.11.2	Runoff Channel Design C-9
C.11.3	Collection Waterways C-12
C.11.4	Pumping System C-12
C.11.5	Monitoring and Collection System C-13
C.12	Land Requirements C-13
C.13	Cover Crop Selection C-14
C.14	System Costs C-14
C.15	Energy Budget C-15
C.16	Alternative Design Methods - Design Example C-15
C.16.1	CRREL Method C-15
C.16.2	University of California, Davis, Method C-17
C.16.3	Comparison of Methods C-19
C.17	References C-19
D	LOCATION OF LAND TREATMENT SYSTEMS
D.1	Slow Rate Systems D-1
D.2	Rapid Infiltration Systems D-5
D.3	Overland Flow Systems D-7
E	DISTRIBUTION SYSTEM DESIGN FOR SLOW RATE
E.1	Introduction E-1
E.2	General Design Considerations E-1
E.2.1	Depth of Water Applied E-1
E.2.2	Application Frequency E-1
E.2.3	Application Rate E-2
E.2.4	Application Period E-2
E.2.5	Application Zone E-2
E.2.6	System Capacity E-3
E.3	Surface Distribution System E-4
E.3.1	Ridge and Furrow Distribution E-4
E.3.2	Graded Border Distribution E-10
E.4	Sprinkler Distribution Systems E-15
E.4.1	Application Rates E-15
E.4.2	Solid Set Sprinkler Systems E-15
E.4.3	Move-Stop Sprinkler Systems E-20
E.4.4	Continuous Move Systems E-24
E.5	References E-31

CONTENTS (Concluded)

Appendix		Page
F	ESTIMATED STORAGE DAYS FOR LAND TREATMENT USING EPA COMPUTER PROGRAMS	F-1
G	GLOSSARY OF TERMS CONVERSION FACTORS	G-1 G-3

FIGURES

No.		Page
1-1	Slow Rate Hydraulic Pathways	1-5
1-2	Rapid Infiltration Hydraulic Pathways	1-10
1-3	Overland Flow	1-12
1-4	Examples of Combined Systems	1-15
2-1	Two-Phase Planning Process	2-2
2-2	Potential Evapotranspiration Versus Mean Annual Precipitation	2-11
2-3	Estimated Design Percolation Rate as a Function of Soil Permeability for SR and RI Land Treatment	2-12
2-4	Winter Operation of Rapid Infiltration at Lake George, New York	2-14
2-5	Estimated Wastewater Storage Days Based only on Climatic Factors	2-15
2-6	Total Land Required (Includes Land for Application, Roads, Storage, and Buildings)	2-17
2-7	Example Area of Soil Map to be Evaluated	2-25
2-8	Example Suitability Map for Soils in Figure 2-7	2-26
2-9	Staffing Requirements for Land Treatment Components (not Including Sewer System or Preapplication Treatment) for Municipally Owned and Operated Systems	2-33
2-10	Dominant Water Rights Doctrines and Areas of Water Surplus or Deficiency	2-36
3-1	Flow Chart of Field Investigations	3-2
3-2	Infiltration Rate as a Function of Time for Several Soils	3-7
3-3	Porosity, Specific Retention, and Specific Yield Variations with Grain Size, South Coastal Basin, California	3-9
3-4	General Relationship Between Specific Yield and Hydraulic Conductivity	3-9
3-5	Typical Pattern of the Changing Moisture Profile During Drying and Drainage	3-11
3-6	Flooding Basin Used for Measuring Infiltration	3-13
3-7	Groove Preparation for Flashing (Berm)	3-14
3-8	Schematic of Finished Installation	3-14
3-9	Infiltration Rate and Cumulative Intake Data Plot	3-16
3-10	Cylinder Infiltrometer in Use	3-18
3-11	Layout of Sprinkler Infiltrometer	3-21
3-12	Schematic of Double-Tube Apparatus	3-25
3-13	Schematic of Air-Entry Permeameter	3-25
3-14	Well and Piezometer Installation	3-29
3-15	Vertical Flows Indicated by Piezometers	3-30
3-16	Definition Sketch for Auger-Hole Technique	3-33

FIGURES (Continued)

No.		Page
3-17	Experimental Setup for Auger-Hole Technique	3-33
4-1	Slow Rate Design Procedure	4-2
4-2	Nitrogen Uptake Versus Growing Days for Annual and Perennial Crops	4-17
4-3	Determination of Storage by EPA Computer Programs According to Climatic Constraints	4-40
4-4	Surface Distribution Methods	4-46
4-5	Fan Nozzle Used for Spray Application at West Dover, Vermont	4-51
4-6	Solid Set Sprinklers with Surface Pipe in a Forest System	4-52
5-1	Rapid Infiltration Design Procedure	5-2
5-2	Effect of Infiltration Rate on Nitrogen Removal	5-19
5-3	Infiltration Basin Outlet and Splash Pad	5-24
5-4	Interbasin Transfer Structure with Adjustable Weir	5-24
5-5	Natural Drainage of Renovated Water Into Surface Water	5-29
5-6	Example Design for Subsurface Flow to Surface Water	5-31
5-7	Schematic of Ground Water Mound	5-32
5-8	Mounding Curve for Center of a Square Recharge Area	5-34
5-9	Mounding Curve for Center of a Rectangular Recharge Area at Different Ratios of Length (L) to Width (W)	5-34
5-10	Rise and Horizontal Spread of Mound Below a Square Recharge Area	5-36
5-11	Rise and Horizontal Spread of Mound Below a Rectangular Recharge Area Whose Length is Twice its Width	5-37
5-12	Centrally Located Underdrain	5-39
5-13	Underdrain System Using Alternating Infiltration and Drying Strips	5-40
5-14	Parameters Used in Drain Design	5-41
5-15	Well Configurations	5-43
6-1	Overland Flow Design Procedure	6-2
6-2	Surface Distribution Using Gated Pipe for OF	6-23
6-3	Distribution for OF Using Low Pressure Fan Spray Nozzles	6-24
6-4	Alternative Sprinkler Configurations for Overland Flow Distribution	6-26
6-5	Land Plane Used for Final Grading	6-30
7-1	Land Area Estimates for Preliminary Planning Process (Including Land for Preapplication Treatment)	7-7
7-2	Typical Annual Hydraulic Loading Rate of Small SR and OF Systems	7-12

FIGURES (Concluded)

No.		Page
7-3	Typical Annual Hydraulic Loading Rate of Small SR Systems	7-13
7-4	Overflow Control Structure for Pond Discharge to SR System	7-21
7-5	Treatment Facility Layout - Kennett Square, Pennsylvania, SR System	7-23
7-6	SR Facilities at Kennett Square, Pennsylvania	7-24
8-1	Center Pivot System	8-7
8-2	Automatic Surface Irrigation System	8-8
A-1	Soils Map	A-3
A-2	System Layout: Forage Crop Alternative	A-18
A-3	System Layout: Forest Crop Alternative	A-26
B-1	Soils Map, Sites 1 and 2	B-4
B-2	Ground Water Contours	B-7
B-3	Intake Curves - Infiltration Basin 1	B-9
B-4	Community B Rapid Infiltration System Flowsheet	B-15
B-5	Community B Site Layout	B-16
B-6	Underdrain Location	B-19
C-1	Proposed Overland Flow Treatment Site	C-3
C-2	Typical Overland Flow Slope	C-8
C-3	Contour Map of Proposed Overland Flow Treatment System	C-10
C-4	Overland Flow System Layout	C-11
E-1	Surface Distribution Methods	E-5
E-2	Aluminum Hydrant and Gated Pipe at Sweetwater, Texas	E-8
E-3	Outlet Valve for Border Strip Application	E-13
E-4	Solid Set Sprinkler System	E-16
E-5	Move-Stop Sprinkler Systems	E-22
E-6	Side Wheel Roll Sprinkler System	E-23
E-7	Continuous Move Sprinkler Systems	E-25
E-8	Hose-Drag Traveling Gun Sprinkler	E-26
E-9	Center Pivot Rig	E-30
E-10	Center Pivot Irrigation System	E-30

TABLES

No.		Page
1-1	Comparison of Typical Design Features for Land Treatment Processes	1-3
1-2	Comparison of Site Characteristics for Land Treatment Processes	1-3
1-3	Expected Quality of Treated Water from Land Treatment Processes	1-4
2-1	Important Constituents in Typical Domestic Wastewater	2-3
2-2	Comparison of Trace Elements in Water and Wastewaters	2-4
2-3	Typical BOD Loading Rates	2-4
2-4	National Interim Primary Drinking Water Standards, 1977	2-6
2-5	Summary of Climatic Analyses	2-8
2-6	Land Use Suitability Factors for Identifying Land Treatment Sites	2-19
2-7	Grade Suitability Factors for Identifying Land Treatment Sites	2-19
2-8	Soil Textural Classes and General Terminology Used in Soil Descriptions	2-21
2-9	Typical Soil Permeabilities and Textural Classes for Land Treatment Processes	2-22
2-10	Site Selection Guidelines	2-23
2-11	Rating Factors for Site Selection	2-24
2-12	Characteristics of Soil Series Mapped in Figure 2-7	2-25
2-13	Example Use of Rating Factors for Site Selection	2-26
2-14	Applicability of Recovery Systems for Renovated Water	2-29
2-15	Lease/Easement Requirements for Construction Grants Program Funding	2-31
2-16	Potential Water Rights Problems for Land Treatment Alternatives	2-37
3-1	Summary of Field Tests for Land Treatment Processes	3-3
3-2	Comparison of Infiltration Measurement Techniques	3-12
3-3	Sample Comparison of Infiltration Measurement Using Flooding and Sprinkling Techniques	3-12
3-4	Suggested Vertical Placement of Tensiometers in Basin Infiltration Tests	3-15
3-5	Measured Ratios of Horizontal to Vertical Conductivity	3-32
3-6	Interpretation of Soil Chemical Tests	3-39
4-1	BOD Removal Data for Selected SR Systems	4-3
4-2	Nitrogen Removal Data for Selected SR Systems	4-4

TABLES (Continued)

No.		Page
4-3	Phosphorus Removal Data for Typical SR Systems	4-6
4-4	Trace Element Behavior During SR Land Treatment	4-8
4-5	Suggested Maximum Applications of Trace Elements to Soils Without Further Investigations	4-9
4-6	Coliform Data for Several SR Systems	4-10
4-7	Benzene, Chloroform, and Trichloroethylene in Muskegon Wastewater Treatment System	4-11
4-8	Relative Comparison of Crop Characteristics	4-13
4-9	Summary of Operational Forest Land Treatment Systems in the United States Receiving Municipal Wastewater	4-15
4-10	Height Growth Response of Selected Tree Species	4-15
4-11	Nutrient Uptake Rates for Selected Crops	4-16
4-12	Estimated Net Annual Nitrogen Uptake in the Overstory and Understory Vegetation of Fully Stocked and Vigorously Growing Forest Ecosystems in Selected Regions of the United States	4-19
4-13	Biomass and Nitrogen Distribution by Tree Component for Stands in Temperate Regions	4-20
4-14	Examples of Estimated Monthly Potential Evapotranspiration for Humid and Subhumid Climates	4-21
4-15	Consumptive Water Use and Irrigation Requirements for Selected Crops at San Joaquin Valley, California	4-22
4-16	Summary of Wastewater Constituents Having Potential Adverse Effects	4-24
4-17	Water Balance to Determine Hydraulic Loading Rates Based on Soil Permeability	4-31
4-18	Estimating of Storage Volume Requirements Using Water Balance Calculations	4-38
4-19	Summary of Computer Programs for Determining Storage from Climatic Variables	4-39
4-20	Final Storage Volume Requirement Calculations	4-42
4-21	Surface Distribution Methods and Conditions of Use	4-47
4-22	Advantages and Disadvantages of Sprinkler Distribution Systems Relative to Surface Distribution Systems	4-49
4-23	Sprinkler System Characteristics	4-49
4-24	Suggested Service Life for Components of Distribution System	4-54
4-25	Recommended Design Factors for Tailwater Return Systems	4-57

TABLES (Continued)

No.		Page
4-26	Approximate Critical Levels of Nutrients in Soils for Selected Crops in California	4-59
4-27	Grazing Rotation Cycles for Different Numbers of Pasture Areas	4-62
4-28	Recommended Soil Contact Pressure	4-67
5-1	BOD Removal for Selected RI Systems	5-4
5-2	Nitrogen Removal Data for Selected RI Systems	5-5
5-3	Phosphorus Removal Data for Selected RI Systems	5-6
5-4	Comparison of Trace Element Levels to Irrigation and Drinking Water Limits	5-7
5-5	Heavy Metal Retention in an Infiltration Basin	5-7
5-6	Fecal Coliform Removal Data for Selected RI Systems	5-8
5-7	Reported Isolations of Virus at RI Sites	5-9
5-8	Recorded Trace Organic Concentrations at Selected RI Sites	5-10
5-9	Suggested Preapplication Treatment Levels	5-11
5-10	Typical Hydraulic Loading Rates for RI Systems	5-13
5-11	Suggested Annual Hydraulic Loading Rates	5-14
5-12	Typical Hydraulic Loading Cycles	5-16
5-13	Suggested Loading Cycles	5-17
5-14	Minimum Number of Basins Required for Continuous Wastewater Application	5-25
6-1	OF Design and Operating Parameters	6-3
6-2	Summary of Process Operating Parameters, BOD and SS Performance at OF Systems	6-4
6-3	Summary of Nitrogen and Phosphorus Performance at OF Systems	6-5
6-4	Removal Efficiencies of Heavy Metals at Different Hydraulic Rates at Utica, Mississippi	6-9
6-5	Overland Flow Design Guidelines	6-12
7-1	Types and Sources of Data Required for Design of Small Land Treatment Systems	7-2
7-2	General Characteristics of Small Land Treatment Systems	7-3
7-3	Typical Staffing Requirements at Small Systems	7-6
7-4	Recommended Level of Preapplication Treatment	7-9
7-5	Typical Design Parameters for Several Types of Ponds	7-10
7-6	Nitrogen Uptake Rates for Selected Crops	7-14
7-7	Design Information for SR System	7-19
7-8	Design Information for Chapman RI System	7-27
7-9	Wastewater Flows to Chapman RI System	7-29
7-10	Treatment Performance of Carbondale OF System	7-31
8-1	Energy Requirements for Crop Production	8-4
8-2	Most Common Unit Energy Requirements for Land Treatment of Municipal Wastewater	8-5

TABLES (Continued)

No.		Page
8-3	Example System Characteristics	8-8
8-4	Comparison of Conventional and Automated Ridge and Furrow Systems for 38,000 m ³ /d	8-9
8-5	Comparison of Impact and Drop-Type Center Pivot System Nozzle Designs on Energy Requirements	8-10
8-6	Total Annual Energy for Typical 3,785 m ³ /d System	8-11
9-1	Land Treatment Methods and Concerns	9-2
9-2	Relationship of Pollutants to Health Effects	9-2
9-3	EPA Long-Term Effects Studies	9-3
9-4	Tolerance of Selected Crops to Salinity in Irrigation Water	9-7
9-5	Mass Balance of Trace Elements in OF System at Utica, Mississippi	9-9
9-6	Trace Element Content of Forage Grasses at Selected SR Systems	9-11
9-7	Trace Element Drinking and Irrigation Water Standards	9-12
9-8	Virus Transmission Through Soil at RI Systems	9-15
9-9	Aerosol Bacteria at Land Treatment Sites	9-18
9-10	Aerosol Enteroviruses at Land Treatment Sites	9-19
9-11	Comparison of Coliform Levels in Aerosols at Activated Sludge and Slow Rate Land Treatment Facilities	9-20
9-12	Trace Organics Removals During Sand Filtration	9-21
9-13	Trace Organics Removals at Selected SR Sites	9-23
9-14	Removal of Refractory Volatile Organics by Class at Phoenix RI Site	9-23
9-15	Chloroform and Toluene Removal During OF	9-24
A-1	Population and Wastewater Characteristics	A-2
A-2	Climatic Data for the Worst Year in 5	A-4
A-3	Hydraulic Loading Rates Based on Soil Permeability: Forage Crop Alternative	A-7
A-4	Design Hydraulic Loading Rate	A-9
A-5	Storage Volume Determination: Forage Crop Alternative	A-11
A-6	Final Determination of Storage Volume	A-14
A-7	Design Criteria for Storage Lagoons: Forage Crop Alternative	A-15
A-8	Slow Rate System Design Data: Forage Crop Alternative	A-19
A-9	Cost Estimate Criteria: Forage Crop Alternative	A-19
A-10	Cost Estimate Calculations: Forage Crop Alternative	A-20
A-11	Summary of Costs: Forage Crop Alternative	A-21
A-12	Initial Determination of Storage Volume: Forage Crop Alternative	A-23

TABLES (Concluded)

No.		Page
A-13	Design Data for Storage Pond: Forest Crop Alternative	A-24
A-14	Design Data: Forest Crop Alternative	A-25
A-15	Summary of Cost: Deciduous Forests	A-27
B-1	Projected Wastewater Characteristics	B-1
B-2	Surface Water Discharge Requirements	B-2
B-3	Average Meteorological Conditions	B-3
B-4	General Soil Characteristics: Sites 1 and 2	B-5
B-5	Typical Log of Test Hole	B-6
B-6	Ground Water Quality	B-8
B-7	Cost of Community B RI System	B-21
C-1	Raw Wastewater Characteristics	C-1
C-2	Average Meteorological Conditions	C-2
C-3	Storage Requirements	C-5
C-4	Land Requirements	C-13
C-5	Cost of Community C OF System	C-14
E-1	Optimum Furrow Spacing	E-6
E-2	Suggested Maximum Lengths of Cultivated Furrows for Different Soils, Grades, and Depths of Water to be Applied	E-6
E-3	Design Guidelines for Graded Border Distribution, Deep Rooted Crops	E-11
E-4	Design Guidelines for Graded Border Distribution, Shallow Rooted Crops	E-11
E-5	Recommended Reductions in Application Rates Due to Grade	E-15
E-6	Recommended Spacing of Sprinklers	E-18
E-7	Factor (F) by Which Pipe Friction Loss is Multiplied to Obtain Actual Loss in a Line with Multiple Outlets	E-19
E-8	Recommended Maximum Lane Spacing for Traveling Gun Sprinklers	E-28
F-1	Storage Days Using EPA-1 for 20 Year (5%) and 10 Year (10%) Return Intervals	F-1
F-2	Storage Days Using EPA-2 for 20 Year (5%) and 10 Year (10%) Return Intervals	F-2
F-3	Storage Days Using EPA-3 for 20 Year (5%) and 10 Year (10%) Return Intervals	F-3

CHAPTER 1

INTRODUCTION AND PROCESS CAPABILITIES

1.1 Purpose

The purpose of this manual is to provide criteria and supporting information for planning and process design of land treatment systems. Recommended procedures for planning and design are presented along with state-of-the-art information on treatment performance, energy considerations, and health and environmental effects.

Cost curves are not included in this manual, although some cost information is included in Chapter 2. Costs for planning may be obtained from cost curves in references [1, 2], or through the CAPDET computer system developed by the Corps of Engineers for EPA. CAPDET computer terminals are available in EPA regional offices.

This document is a revision of the Process Design Manual for Land Treatment of Municipal Wastewater sponsored by the U.S. Environmental Protection Agency, U.S. Army Corps of Engineers, and U.S. Department of Agriculture, and published in 1977. The revision is necessary because of the large amount of research data, criteria, and operating experience that has become available in recent years. As a result of PL 92-500 and PL 95-217, the interest in and use of land treatment concepts has increased significantly and is expected to continue to increase.

1.2 Scope

Land treatment is defined as the controlled application of wastewater onto the land surface to achieve a designed degree of treatment through natural physical, chemical, and biological processes within the plant-soil-water matrix.

The scope of this manual is limited to the three major land treatment processes:

- Slow rate (SR)
- Rapid infiltration (RI)
- Overland flow (OF)

These processes are defined later in this chapter and discussed in detail in the design chapters. The titles were adopted for the original 1977 manual to reflect the rate of

wastewater application and the flow path within the process. Prior to the 1977 manual, the term "irrigation" was often used to describe the slow rate process. The present term was chosen to focus attention on wastewater treatment rather than on irrigation of crops.

Subsurface systems, wetlands, and aquaculture were discussed briefly in the 1977 manual but are deleted here since they are now covered in detail in other documents [3, 4]. Land application of sludge, injection wells, evaporation ponds, and other forms of treatment or disposal that involve the soil matrix are also excluded.

Most of the information in this manual is applicable to medium-to-large systems. For small systems, up to 1,000 m³/d (250,000 gal/d), many of the design procedures can be simplified. Special considerations for these small systems and a number of typical examples are discussed in Chapter 7. Case studies for larger systems are available in other publications [5-9]. This manual addresses land treatment of municipal wastewater, not industrial wastes. Under controlled conditions, however, land treatment of many types of industrial wastewaters and even hazardous materials can be both technically and economically feasible.

Although the principal focus in the manual is on the three basic processes (SR, RI, OF), the possibility of combining two or more of the concepts in a continuous system should not be overlooked. Overland flow could be a preapplication step for either SR or RI, or different processes could be used in cold and warm weather.

1.3 Treatment Processes

Typical design features for the three land treatment processes are compared in Table 1-1. The major site characteristics are compared for each process in Table 1-2. These are desirable characteristics and not limits to be adhered to rigorously, as discussed in Chapter 2.

The expected quality of treated water for biochemical oxygen demand (BOD), suspended solids (SS), nitrogen, phosphorus, and fecal coliforms is presented for each process in Table 1-3. The average and expected upper range values are valid for the travel distances and applied wastewater as indicated. The fate of these materials (plus metals, viruses, and trace organics) is discussed in the chapters that follow.

TABLE 1-1
COMPARISON OF TYPICAL DESIGN FEATURES
FOR LAND TREATMENT PROCESSES

Feature	Slow rate	Rapid infiltration	Overland flow
Application techniques	Sprinkler or surface ^a	Usually surface	Sprinkler or surface
Annual loading rate, m	0.5-6	6-125	3-20
Field area required, ha ^b	23-280	3-23	6.5-44
Typical weekly loading rate, cm	1.3-10	10-240	6-40 ^c
Minimum preapplication treatment provided in the United States	Primary sedimentation ^d	Primary sedimentation ^e	Grit removal and comminution ^e
Disposition of applied wastewater	Evapotranspiration and percolation	Mainly percolation	Surface runoff and evapotranspiration with some percolation
Need for vegetation	Required	Optional	Required

- a. Includes ridge-and-furrow and border strip.
- b. Field area in hectares not including buffer area, roads, or ditches for 3,785 m³/d (1 Mgal/d) flow.
- c. Range includes raw wastewater to secondary effluent, higher rates for higher level of preapplication treatment.
- d. With restricted public access; crops not for direct human consumption.
- e. With restricted public access.

Note: See Appendix G for metric conversions.

TABLE 1-2
COMPARISON OF SITE CHARACTERISTICS
FOR LAND TREATMENT PROCESSES

	Slow rate	Rapid infiltration	Overland flow
Grade	Less than 20% on cultivated land; less than 40% on noncultivated land	Not critical; excessive grades require much earthwork	Finish slopes 2-8% ^a
Soil permeability	Moderately slow to moderately rapid	Rapid (sands, sandy loams)	Slow (clays, silts, and soils with impermeable barriers)
Depth to ground water	0.6-1 m (minimum) ^b	1 m during flood cycle ^b ; 1.5-3 m during drying cycle	Not critical ^c
Climatic restrictions	Storage often needed for cold weather and during heavy precipitation	None (possibly modify operation in cold weather)	Storage usually needed for cold weather

- a. Steeper grades might be feasible at reduced hydraulic loadings.
- b. Underdrains can be used to maintain this level at sites with high ground water table.
- c. Impact on ground water should be considered for more permeable soils.

TABLE 1-3
 EXPECTED QUALITY OF TREATED WATER
 FROM LAND TREATMENT PROCESSES^a
 mg/L Unless Otherwise Noted

Constituent	Slow rate ^b		Rapid infiltration ^c		Overland flow ^d	
	Average	Upper range	Average	Upper range	Average	Upper range
BOD	<2	<5	5	<10	10	<15
Suspended solids	<1	<5	2	<5	10	<20
Ammonia nitrogen as N	<0.5	<2	0.5	<2	<4	<8
Total nitrogen as N	3 ^e	<8 ^e	10	<20	5 ^f	<10 ^f
Total phosphorus as P	<0.1	<0.3	1	<5	4	<6
Fecal coliforms, No./100 mL	0	<10	10	<200	200	<2,000

- a. Quality expected with loading rates at the mid to low end of the range shown in Table 1-1.
- b. Percolation of primary or secondary effluent through 1.5 m (5 ft) of unsaturated soil.
- c. Percolation of primary or secondary effluent through 4.5 m (15 ft) of unsaturated soil; phosphorus and fecal coliform removals increase with distance (see Tables 5-3 and 5-6).
- d. Treating comminuted, screened wastewater using a slope length of 30-36 m (100-120 ft).
- e. Concentration depends on loading rate and crop.
- f. Higher values expected when operating through a moderately cold winter or when using secondary effluent at high rates.

1.4 Slow Rate Process

Slow rate land treatment is the application of wastewater to a vegetated land surface with the applied wastewater being treated as it flows through the plant-soil matrix. A portion of the flow percolates to the ground water and some is used by the vegetation. Offsite surface runoff of the applied water is generally avoided in design. Schematic views of the typical hydraulic pathways for SR treatment are shown in Figure 1-1(a)(b)(c). Surface application techniques include ridge-and-furrow and border strip flooding. Application by sprinklers can be from fixed risers or from moving systems, such as center pivots.

1.4.1 Process Objectives

Slow rate processes can be operated to achieve a number of objectives including:

1. Treatment of applied wastewater
2. Economic return from use of water and nutrients to produce marketable crops (irrigation)

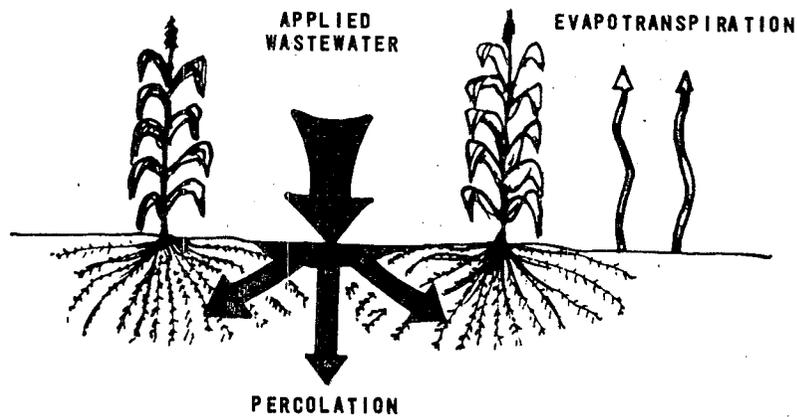

(a) APPLICATION PATHWAY

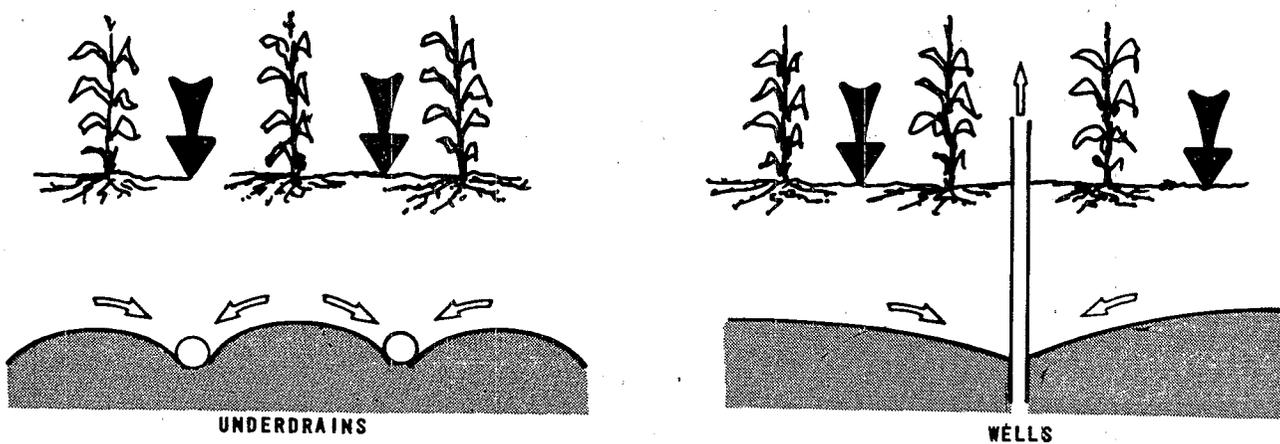

(b) RECOVERY PATHWAYS

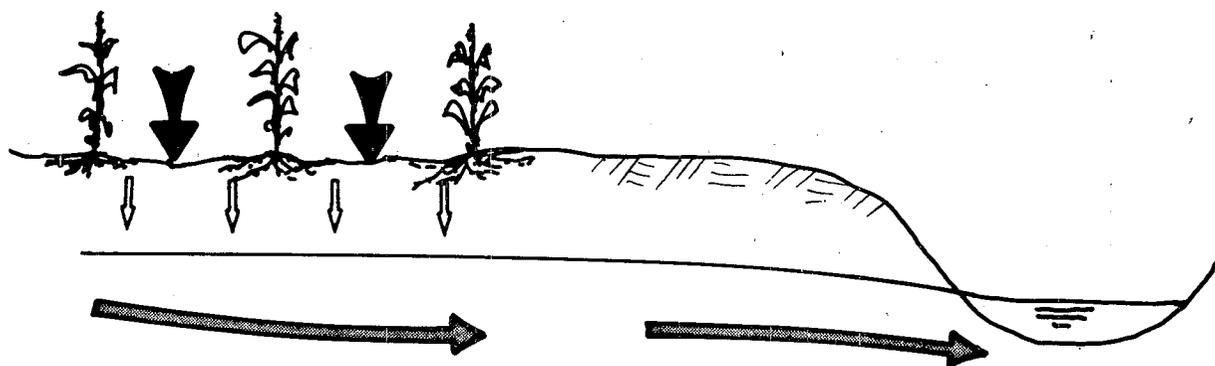

(c) SUBSURFACE PATHWAY

FIGURE 1-1
SLOW RATE HYDRAULIC PATHWAYS

3. Water conservation, by replacing potable water with treated effluent, for irrigation
4. Preservation and enlargement of greenbelts and open space

When requirements are very stringent for nitrogen, phosphorus, BOD, SS, pathogens, metals, and trace organics, they can be met usually with SR treatment. Nitrogen is often the limiting factor for SR design because of EPA drinking water limits on ground water quality. In arid regions, however, maintaining chlorides and total dissolved salts at acceptable levels for crop production may be limiting. Management approaches to meet these objectives within the SR process are discussed under the topics (1) wastewater treatment, (2) agricultural systems, (3) turf systems, and (4) forest systems.

1.4.1.1 Wastewater Treatment

When the primary objective of the SR process is treatment, the hydraulic loading is usually limited either by the hydraulic capacity of the soil or the nitrogen removal capacity of the soil-vegetation matrix. Underdrains are sometimes needed for development of sites with high ground water tables, or where perched water tables or impermeable layers prevent deep percolation. Perennial grasses are often chosen for the vegetation because of their high nitrogen uptake, a longer wastewater application season, and the avoidance of annual planting and cultivation. Corn and other crops with higher market values are also grown on systems where treatment is the major objective. Muskegon, Michigan [10] is a noted example in the United States with over 2,000 hectares (5,000 acres) of corn under cultivation.

1.4.1.2 Agricultural Systems

In the more arid western portions of the United States, the water itself (not the nutrient content) is the most valuable component of the wastewater. Crops are selected for their maximum market potential and the least possible amount of wastewater needed for irrigation. Application rates between 2 to 8 cm/wk (0.8 to 3.1 in./wk) are common. This is enough water to satisfy crop needs, plus a leaching requirement to maintain a desired salt balance in the root zone.

In the more humid east, the water component may be critical at certain times of the year and during extended drought periods, but the nutrients in the wastewater are the most valuable component. Systems are designed to promote the

nutrient uptake by the crop and increase yields. At Muskegon, Michigan, for example, corn yields in 1977 were 6.5 m³/ha (75 bushels per acre) compared to 5.2 m³/ha (60 bushels per acre) for the nonwastewater farming in the same area [10]. Regardless of geographical location, wastewater irrigation can benefit crop production by providing nutrients and moisture.

1.4.1.3 Turf Systems

Golf courses, parks, and other turfed areas are used in many parts of the United States for SR systems, thus conserving potable water supplies. These areas have considerable public access and this requires strict control of pathogenic organisms. This control can be achieved by disinfection or by natural processes in biological treatment ponds or storage ponds.

1.4.1.4 Forest Systems

Slow rate forest systems exist in many states including Oregon, Washington, Michigan, Maryland, Florida, Georgia, Vermont, and New Hampshire. In addition, experimental systems in a variety of locations are being studied extensively to determine permissible loading rates, responses of various tree species, and environmental effects (see Chapter 4).

Forests offer several advantages that make them desirable sites for land treatment:

1. Forest soils often exhibit higher infiltration rates than agricultural soils.
2. Site acquisition costs for forestland are usually lower than site acquisition costs for prime agricultural land.
3. During cold weather, soil temperatures are often higher in forestlands than in agricultural lands.
4. Systems can be developed on steeper grades in the forest as compared to agricultural sites.

The principal limitations to the use of wastewater for forested SR systems are:

1. Water needs and tolerances of some existing trees may be low.

2. Nitrogen removals are relatively low unless young, developing forests are used or conditions conducive to denitrification are present.
3. Fixed sprinklers, which are expensive, are usually necessary.
4. Forest soils may be rocky or very shallow.

1.4.2 Treatment Performance

The SR process is capable of producing the highest degree of wastewater treatment of all the land treatment systems. The quality values shown in Table 1-3 can be expected for most well-designed and well-operated systems.

Organics are reduced substantially by SR land treatment within the top 1 to 2 cm (0.4 to 0.8 in.) of soil. Filtration and adsorption are the initial steps in BOD removal, but biological oxidation is the ultimate treatment mechanism. Filtration is the major removal mechanism for suspended solids. Residues remaining after oxidation and the inert solids become part of the soil matrix.

Nitrogen is removed primarily by crop uptake, which varies with the type of crop grown and the crop yield. To remove the nitrogen effectively, the crop must be harvested. Denitrification can also be significant, even if the soil is in an aerobic condition most of the time. Other nitrogen removal mechanisms include ammonia volatilization and storage in the soil.

Phosphorus is removed from solution by fixation processes in the soil, such as adsorption and chemical precipitation. Removal efficiencies are generally very high for SR systems and are more dependent on the soil properties than on the concentration of the phosphorus applied. Residual phosphorus concentrations in the percolate will generally be less than 0.1 mg/L [11]. A small but significant portion of the phosphorus applied is taken up and removed with the crop.

1.5 Rapid Infiltration Process

In RI land treatment, most of the applied wastewater percolates through the soil, and the treated effluent drains naturally to surface waters or joins the ground water. The wastewater is applied to moderately and highly permeable soils (such as sands and loamy sands), by spreading in basins or by sprinkling, and is treated as it travels

through the soil matrix. Vegetation is not usually planned, but there are some exceptions, and emergence of weeds and grasses usually does not cause problems.

The schematic view in Figure 1-2(a) shows the typical hydraulic pathway for rapid infiltration. A much greater portion of the applied wastewater percolates to the ground water than with SR land treatment. There is little or no consumptive use by plants. Evaporation ranges from about 0.6 m/yr (2 ft/yr) for cool regions to 2 m/yr (6 ft/yr) for hot arid regions. This is usually a small percentage of the hydraulic loading rates.

In many cases, recovery of renovated water is an integral part of the system. This can be accomplished using underdrains or wells, as shown in Figure 1-2(b). In some cases, the water drains naturally to an adjacent surface water (Figure 1-2(c)). Such systems can provide a higher level of treatment than most mechanical systems discharging to the same surface water.

1.5.1 Process Objectives

The objective of RI is wastewater treatment. Uses for the treated water can include:

1. Ground water recharge
2. Recovery of renovated water by wells or underdrains with subsequent reuse or discharge
3. Recharge of surface streams by interception of ground water
4. Temporary storage of renovated water in the aquifer

If ground water quality is being degraded by saltwater intrusion, ground water recharge by RI can help to create a barrier and protect the existing fresh ground water. In many cases, the major treatment goal is conversion of ammonia nitrogen to nitrate nitrogen prior to discharge to surface waters. The RI process offers a cost-effective method for achieving this goal with recovery or recharge as described in items 2 and 3 above. Return of the renovated water to the surface by wells, underdrains, or ground water interception may be necessary or advantageous when discharge to a particular surface water body is controlled by water rights, or when existing ground water quality is not compatible with expected renovated water quality. At Phoenix, Arizona, for example, renovated water is being withdrawn by wells to allow reuse of the water for irrigation.

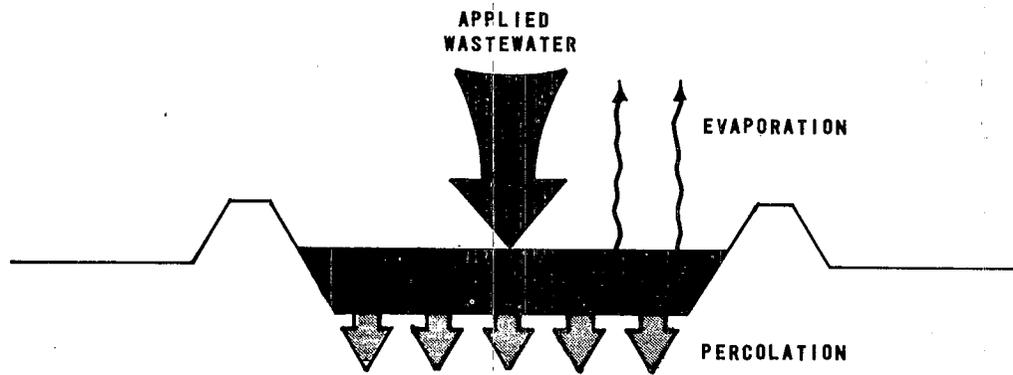

(a) HYDRAULIC PATHWAY

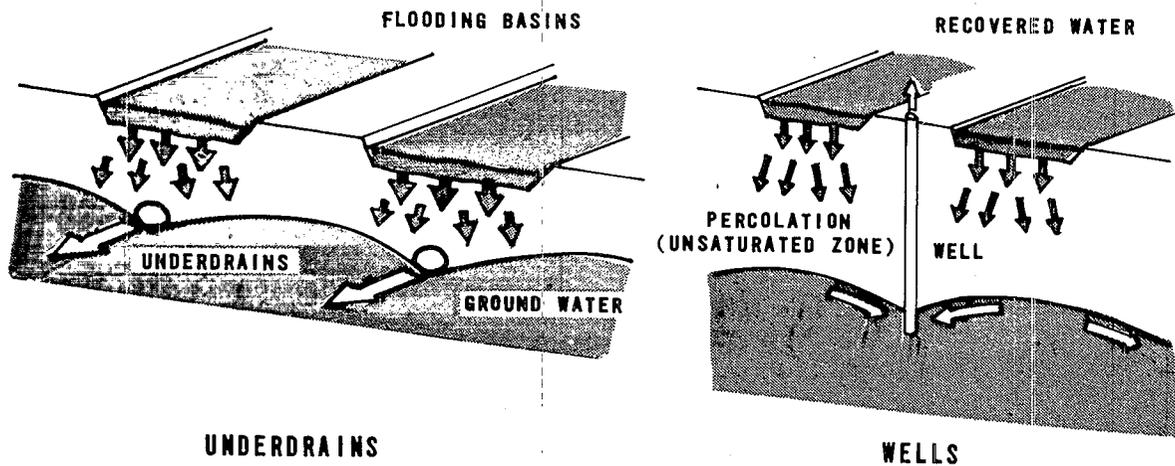

UNDERDRAINS

WELLS

(b) RECOVERY PATHWAYS

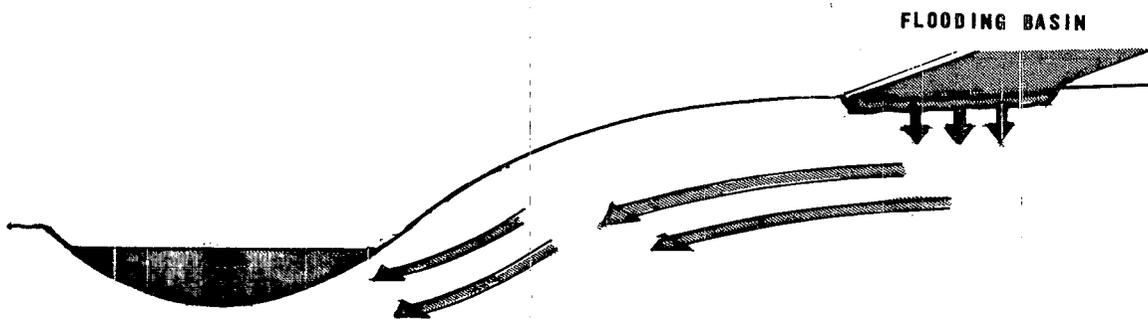

(c) NATURAL DRAINAGE INTO SURFACE WATERS

FIGURE 1-2
RAPID INFILTRATION HYDRAULIC PATHWAYS

1.5.2 Treatment Performance

Removals of wastewater constituents by the filtering and straining action of the soil are excellent. Suspended solids, BOD, and fecal coliforms are almost completely removed.

Nitrification of the applied wastewater is essentially complete when appropriate hydraulic loading cycles are used. Thus, for communities that have ammonia standards in their discharge requirements, RI can provide an effective way to meet such standards.

Generally, nitrogen removal averages 50% unless specific operating procedures are established to maximize denitrification. These procedures include optimizing the application cycle, recycling the portions of the renovated water that contain high nitrate concentrations, reducing the infiltration rate, and supplying an additional carbon source. Using these procedures in soil column studies, average nitrogen removals of 80% have been achieved. Nitrogen removal by denitrification can be significant if the hydraulic loading rate is at the mid range or below the values in Table 1-1 and the BOD to nitrogen ratio is 3 or more.

Phosphorus removals can range from 70 to 99%, depending on the physical and chemical characteristics of the soil. As with SR systems, the primary removal mechanism is adsorption with some chemical precipitation, so the long-term capacity is limited by the mass and the characteristics of soil in contact with the wastewater. Removals are related also to the residence time of the wastewater in the soil, the travel distance, and other climatic and operating conditions.

1.6 Overland Flow Process

In OF land treatment, wastewater is applied at the upper reaches of grass covered slopes and allowed to flow over the vegetated surface to runoff collection ditches. The OF process is best suited to sites having relatively impermeable soils. However, the process has been used with success on moderately permeable soils with relatively impermeable subsoils. The wastewater is renovated by physical, chemical, and biological means as it flows in a thin film down the length of the slope. A schematic view of OF treatment is shown in Figure 1-3(a), and a pictorial view of a typical system is shown in Figure 1-3(b). As shown in Figure 1-3(a), there is relatively little percolation involved either because of an impermeable soil or a subsurface barrier to percolation.

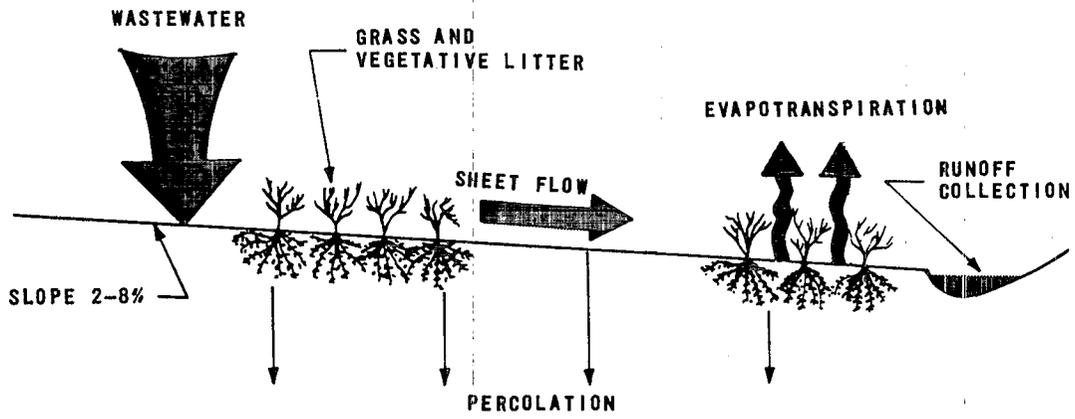

(a) HYDRAULIC PATHWAY

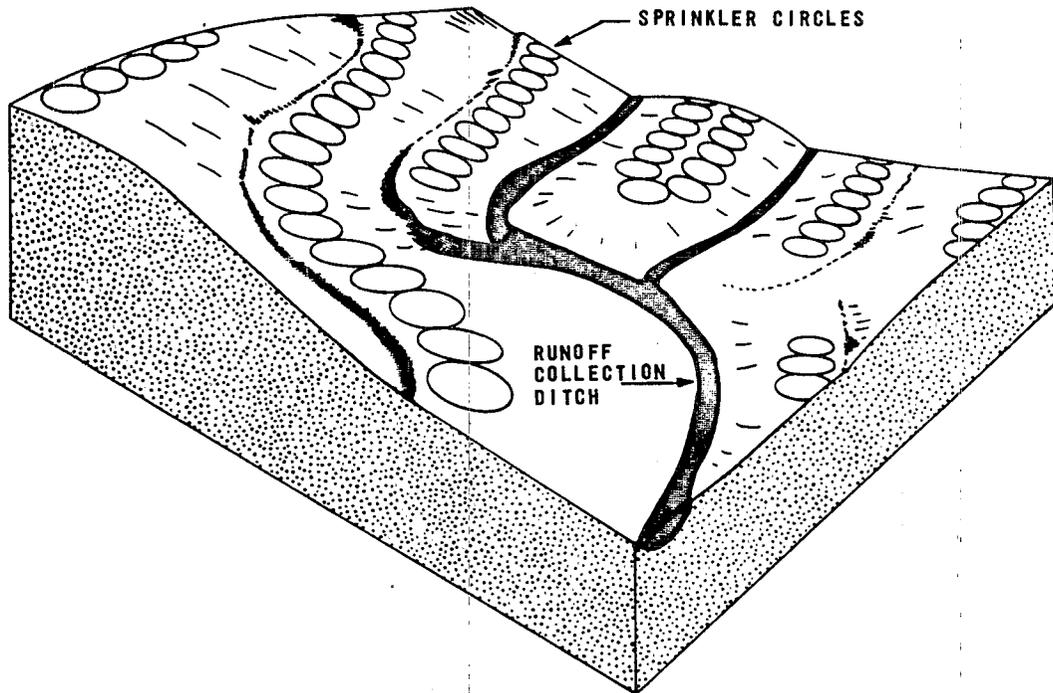

(b) PICTORIAL VIEW OF SPRINKLER APPLICATION

FIGURE 1-3
OVERLAND FLOW

Interest by municipalities and design engineers has spurred research and demonstration projects in South Carolina, New Hampshire, Mississippi, Oklahoma, Illinois, and California. Cold-weather operation has been demonstrated through several winters at Hanover, New Hampshire. Rational design equations have been developed based on research at Hanover and at Davis, California.

1.6.1 Process Objectives

The objectives of OF are wastewater treatment and, to a minor extent, crop production. Treatment objectives may be either:

1. To achieve secondary effluent quality when applying screened raw wastewater, primary effluent, or treatment pond effluent.
2. To achieve high levels of nitrogen, BOD, and SS removals.

Treated water is collected at the toe of the OF slopes and can be either reused or discharged to surface water. Overland flow can also be used for the preservation of greenbelts.

1.6.2 Treatment Performance

Biological oxidation, sedimentation, and filtration are the primary removal mechanisms for organics and suspended solids.

Nitrogen removals are a combination of plant uptake, denitrification, and volatilization of ammonia nitrogen. The dominant mechanism in a particular situation will depend on the forms of nitrogen present in the wastewater, the amount of carbon available, the temperature, and the rates and schedules of wastewater application. Permanent nitrogen removal by the plants is only possible if the crop is harvested and removed from the field. Ammonia volatilization can be significant if the pH of the wastewater is above 7. Nitrogen removals usually range from 75 to 90% with the form of runoff nitrogen dependent on temperature and on application rates and schedule. Less removal of nitrate and ammonium may occur during cold weather as a result of reduced biological activity and limited plant uptake.

Phosphorus is removed by adsorption and precipitation in essentially the same manner as with the SR and RI methods. Treatment efficiencies are somewhat limited because of the limited contact between the wastewater and the adsorption

sites within the soil. Phosphorus removals usually range from 50 to 70% on a mass basis. Increased removals may be obtained by adding alum or ferric chloride to the wastewater just prior to application on the slope.

1.7 Combination Systems

In areas where effluent quality must be very good, or where a high degree of treatment reliability must be maintained, combinations of land treatment processes may be desirable. For example, either an SR, RI, or a wetlands treatment system could follow an OF system and would result in better overall treatment than the OF alone. In particular, these combinations could be used to improve BOD, suspended solids, nitrogen, and phosphorus removals.

Similarly, OF could be used prior to RI to reduce nitrogen levels to acceptable levels. This combination was demonstrated successfully in a pilot scale study at Ada, Oklahoma, using screened raw wastewater for the OF portion [12].

Rapid infiltration may also precede SR land treatment. In this combination, renovated water quality following RI is expected to be high enough that even the most restrictive requirements regarding the use of renovated water on food crops can be met. Also, the ground water aquifer can be used to store renovated water to correspond with crop irrigation schedules. Some of these combinations are shown schematically in Figure 1-4.

1.8 Guide to Intended Use of the Manual

This manual is organized similarly to the original 1977 edition except that the design examples are included as appendixes. Completely new features in this manual are chapters on energy, and health and environmental effects.

Chapters 2 through 6 follow, in sequence, a logical procedure for planning and design of land treatment systems. The procedure commences (Chapter 2) with screening of the entire study area to identify potential land treatment sites. The Phase 1 planning is based on existing information and data on land use, water rights, topography, soils, and geohydrology. If potentially suitable sites exist, the Phase 2 planning then involves detailed site investigations (Chapter 3) to determine process suitability and preliminary design criteria (Chapters 4, 5, and 6).

Process selection for a particular situation is influenced by health and environmental issues (Chapter 9) and by energy

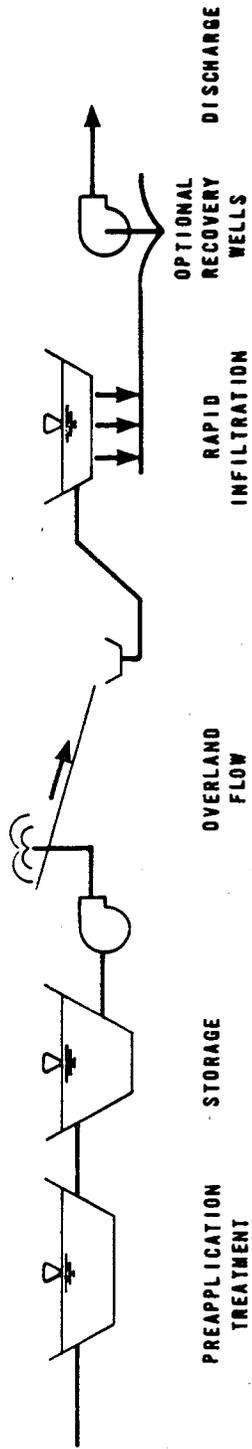

a) OVERLAND FLOW FOLLOWED BY RAPID INFILTRATION

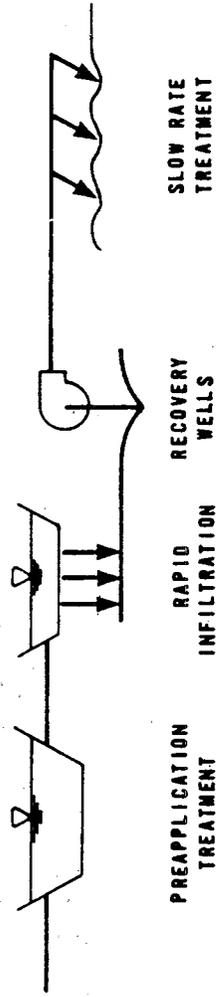

b) RAPID INFILTRATION FOLLOWED BY SLOW RATE TREATMENT

FIGURE 1-4
EXAMPLES OF COMBINED SYSTEMS

needs (Chapter 8). Thus, Phase 2 planning requires the use of all the technical chapters in the manual.

Small communities (up to 3,500 population) do not usually need the same level of planning and investigation that is essential for large systems. Nor do they always need the level of sophistication that is normally provided, in terms of equipment and management procedures, for large systems. Procedures and shortcuts that are unique to small land treatment systems are described in Chapter 7. Typical examples are included to illustrate the level of effort needed in field work and design.

The final design of a land treatment system needs only to draw on the pertinent chapter (4, 5, or 6) for the intended process. Some additional field investigation (Chapter 3) may be necessary to optimize hydraulic loading rates and ensure proper subsurface flow conditions. The design chapters do not present complete detail on the hardware (i.e., pumps, pipe materials, sprinkler rigs, etc.) involved. Other sources will be needed for these design details. The cost information in reference [1] or in the CAPDET program is suitable for planning, comparison of alternatives, and preliminary design only. The final construction cost estimate should be derived in the conventional way (by material take-off, etc.) from the final plans.

Appendixes A, B, and C provide design examples of SR, RI, and OF and are intended to demonstrate the design procedure. Energy budgets and costs are provided along with the process design. Appendix D contains a representative list of currently operating municipal (also federal government and selected industrial) land treatment systems in the United States.

Appendix E provides information on designing irrigation systems for SR facilities. The level of detail in this appendix is sufficient to develop preliminary layouts and sizing for distribution system components. Appendix F contains a list of communities for which the EPA programs that determine storage requirements based on climate (Section 4.6.2) have been run. The final appendix, G, provides a glossary of terms and conversion factors from metric to U.S. customary units for all figures and tables.

The design approach for land treatment has been essentially empirical, i.e., observation of successful performance followed by derivation of criteria and mathematical expressions that describe overall performance. Essentially the same approach was used to develop design criteria for

activated sludge and other biological treatment processes. The physical, chemical, and biological reactions and interactions occurring in all treatment processes are quite complex and are difficult to define mathematically. Such definition is still evolving for activated sludge as well as land treatment. As a result, the design procedures presented in this manual are still conservative and are based on successful operating experience.

More rational design procedures however, are becoming available (see Section 6.11). In addition, there are mathematical models available that may be used to evaluate the response to a particular constituent (nitrogen, phosphorus, etc.) or used in combination to describe the entire system performance. A brief summary of models that are currently available is included in reference [13]. A more detailed discussion of specific models for land treatment can be found in reference [14].

1.9 References

1. Reed, S.C., et al. Cost of Land Treatment Systems. U.S. Environmental Protection Agency. EPA-430/9-75-003, MCD 10. September 1979.
2. Culp/Wesner/Culp. Water Reuse and Recycling. Vol. 2. U.S.D.I. OWRT/RU-79/2. 1979.
3. U.S. Environmental Protection Agency. Aquaculture Systems for Wastewater Treatment: Seminar Proceedings and Engineering Assessment. Office of Water Program Operations. EPA-430/9-80-006, MCD 67. September 1979.
4. U.S. Environmental Protection Agency. Design Manual for Onsite Wastewater Treatment and Disposal Systems. Center of Environmental Research Information. EPA-645/1-80-012. October 1980.
5. U.S. Environmental Protection Agency. Slow Rate Land Treatment: A Recycle Technology. Office of Water Program Operations. EPA-430/9-80-011a, MCD 70. October 1980.
6. U.S. Environmental Protection Agency. Rapid Infiltration Land Treatment: A Recycle Technology. Office of Water Program Operations. EPA-430/9-80-011b, MCD 71. (In Press) 1981.

7. Proceedings of the International Symposium on Land Treatment of Wastewater. Volumes 1 and 2. Hanover, New Hampshire. August 20-25, 1978.
8. Hinrichs, D.J., et al. Assessment of Current Information on Overland Flow Treatment. U.S. Environmental Protection Agency. Office of Water Program Operations. EPA-430/9-80-002, MCD 66. September 1980.
9. Leach, L.E., C.G. Enfield, and C.C. Harlin, Jr. Summary of Long-Term Rapid Infiltration System Studies. U.S. Environmental Protection Agency. Office of Research and Development. Ada, Oklahoma. EPA-600/2-80-165. July 1980.
10. Walker, J.M. Wastewater: Is Muskegon County's Solution Your Solution? U.S. Environmental Protection Agency. EPA-905/2-76-004, MCD-34. August 1979.
11. Jenkins, T.F. and A.J. Palazzo. Wastewater Treatment by a Slow Rate Land Treatment System. U.S. Army Corps of Engineers, Cold Regions Research and Engineering Laboratory. CRREL Report 81-14. Hanover, New Hampshire. August 1981.
12. Thomas, R.E., et al. Feasibility of Overland Flow for Treatment of Raw Domestic Wastewater. U.S. Environmental Protection Agency. EPA-66/2-74-087. 1974.
13. Iskandar, I.K. Overview on Modeling Wastewater Renovation by Land Treatment. USACRREL, Special Report. USACRREL, Hanover, New Hampshire. 1981.
14. Iskandar, I.K. (ed.). Modeling Wastewater Renovation: Land Treatment. Wiley Interscience, New York. 1981.

CHAPTER 2

PLANNING AND TECHNICAL ASSESSMENT

2.1 Planning Procedure

Adequate planning must precede any wastewater treatment system design to ensure selection of the most cost-effective process that is feasible for the situation under consideration. In many cases, guidelines or specifications for the planning procedure are provided by the agency responsible for the project. The purpose of this chapter is to present those aspects of the planning procedure that are either unique or require special emphasis because of land treatment.

Process selection for land treatment systems is more dependent on site conditions than are mechanical treatment alternatives. This can mean that there is a need for extensive and, in some cases, expensive site investigation and field testing programs. To avoid unnecessary effort and expense, a two-phase planning approach has been developed and adopted by most agencies concerned. As shown in Figure 2-1, Phase 1 involves identification of potential sites via screening of available information and experience. If potential sites for any of the land treatment processes are identified, the study moves into Phase 2. This phase includes field investigations and an evaluation of the alternatives.

2.2 Phase 1 Planning

Early during Phase 1, basic data that are common to all wastewater treatment alternatives must be collected and analyzed along with land treatment system requirements to determine whether land treatment is a feasible concept. If no limiting factors are identified that would eliminate land treatment from further consideration, the next steps are to identify potential land treatment sites and to evaluate the feasibility of each site.

2.2.1 Preliminary Data

Service area definition, population forecasts, wastewater quality and quantity projections, and water quality requirements are usually either specified or determined using procedures established by the responsible authority. With the exception of water quality requirements, the data are generally the same for all forms of wastewater treatment. A few aspects are specific to land treatment and are discussed in this section.

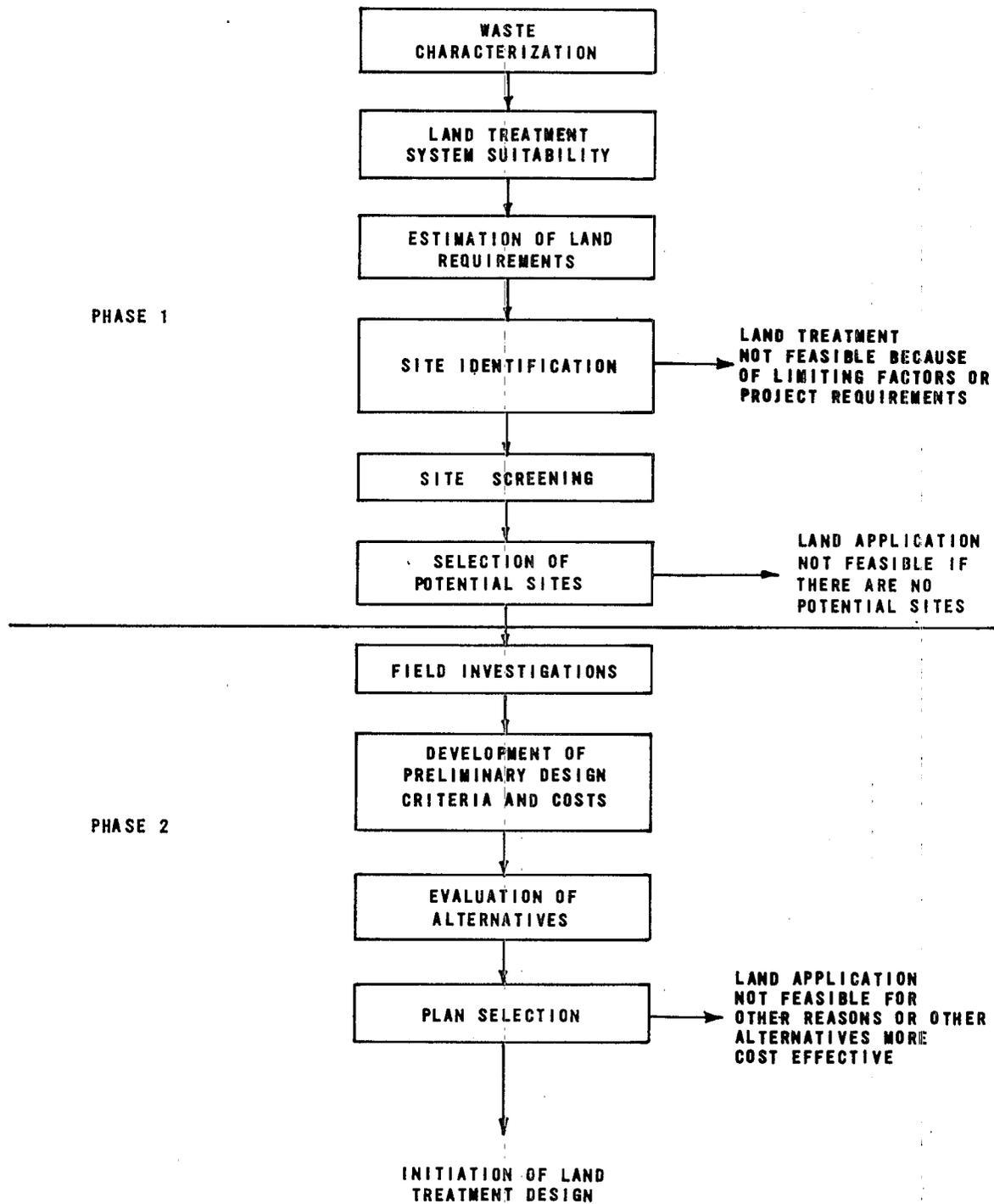

**FIGURE 2-1
TWO-PHASE PLANNING PROCESS**

2.2.1.1 Wastewater Quality and Loadings

Major constituents in domestic wastewater are presented in Table 2-1. Trace element concentration ranges are shown in Table 2-2. The values in these tables may be used for planning purposes when a community's water quality has not been determined. Other important parameters in land treatment design can include total dissolved solids, pH, potassium, sodium, calcium, magnesium, boron, barium, selenium, fluoride, and silver.

TABLE 2-1
IMPORTANT CONSTITUENTS IN TYPICAL
DOMESTIC WASTEWATER [1]
mg/L

Constituent	Type of wastewater		
	Strong	Medium	Weak
BOD	400	220	110
Suspended solids	350	220	100
Nitrogen (total as N)	85	40	20
Organic	35	15	8
Ammonia	50	25	12
Nitrate	0	0	0
Phosphorus (total as P)	15	8	4
Organic	5	3	1
Inorganic	10	5	3
Total organic carbon	290	160	80

For municipal land treatment systems, BOD and suspended solids loadings seldom limit system capacity. Typical BOD loading rates at municipal systems are shown in Table 2-3 and are much lower than rates used successfully in land treatment of food processing wastewaters. Suspended solids loadings at these industrial systems would be similar to the BOD loadings shown in Table 2-3.

In contrast, if nitrogen removal is required, nitrogen loading may limit the system capacity. Nitrogen removal capacity depends on the crop grown, if any, and on system management practices. The engineer should consult Sections 4.5 and 5.4.3.1 to determine whether nitrogen loading will govern system capacity and, therefore, land area requirements.

TABLE 2-2
COMPARISON OF TRACE ELEMENTS IN
WATER AND WASTEWATERS
mg/L

Element	Untreated wastewater ^a	Maximum recommended concentrations for irrigation water ^b	EPA recommended drinking water standards ^c
Arsenic	0.003	0.1	0.05
Boron	0.3-1.8	0.5-2.0	No standard
Cadmium	0.004-0.14	0.01	0.01
Chromium	0.02-0.700	0.1	0.05
Copper	0.02-3.36	0.2	1.0
Iron	0.9-3.54	5.0	0.3
Lead	0.05-1.27	5.0	0.05
Manganese	0.11-0.14	0.2	0.05
Mercury	0.002-0.044	No standard	0.002
Nickel	0.002-0.105	0.2	No standard
Zinc	0.030-8.31	2.0	5.0

- a. The concentrations presented encompass the range of values reported in references [2-6].
- b. Based on unlimited irrigation at 1.0 m/yr (3 ft/yr).
- c. Reference [7]:

TABLE 2-3
TYPICAL BOD LOADING RATES
kg/ha·yr

	Slow rate	Rapid infiltration	Overland flow
Range for municipal wastewater	370-1,830	8,000-46,000	2,000-7,500

Note: See Appendix G for metric conversions.

In some cases, other wastewater constituents such as phosphorus or trace elements may control design. For example, if wastewater trace element concentrations exceed the maximum recommended concentrations for irrigation water (Table 2-2), SR systems may be infeasible or may require special precautions. This is rare, however, and most municipal systems will be limited either by hydraulic capacity or nitrogen loading.

2.2.1.2 Water Quality Requirements

Land treatment systems have somewhat unique discharge requirements because many of these systems do not have

conventional point discharges to receiving surface waters. In the past, the ability of the soil to treat wastewater was not well recognized. As a result, discharge standards were often imposed on a wastewater prior to its application on land, thereby increasing treatment costs and energy requirements without significantly improving overall treatment performance. More recently, land has been recognized as an important component in the treatment process. For this reason, discharge requirements now apply to water quality following land treatment.

For systems that discharge to receiving waters, such as OF systems and some underdrained or naturally draining SR and RI systems, renovated water quality must meet surface discharge requirements. For systems where the renovated water remains underground, EPA has established guidance for three categories of ground water discharge that meet the criteria for best practicable waste treatment. These three categories are as follows:

Case 1 - The ground water can potentially be used for drinking water supply.

The chemical and pesticide levels in Table 2-4 should not be exceeded in the ground water. If the existing concentration in the ground water of an individual parameter exceeds the standards, there should be no further increase in the concentration of that parameter resulting from land application of wastewater.

Case 2 - The ground water is used for drinking water supply.

The same criteria as Case 1 apply and the bacteriological quality criterion from Table 2-4 also applies in cases where the ground water is used without disinfection.

Case 3 - Uses other than drinking water supply.

Ground water criteria should be established by the Regional Administrator in conjunction with appropriate state agencies based on the present or potential use of the ground water.

For each ground water category, discharge requirements must be met at the boundary of the land treatment project.

TABLE 2-4
 NATIONAL INTERIM PRIMARY
 DRINKING WATER STANDARDS, 1977 [7,8]

Constituent or characteristic	Value ^a	Reason for standard
Physical		
Turbidity, units	1 ^b	Aesthetic
Chemical, mg/L		
Arsenic	0.05	Health
Barium	1.0	Health
Cadmium	0.01	Health
Chromium	0.05	Health
Fluoride	1.4-2.4 ^c	Health
Lead	0.05	Health
Mercury	0.002	Health
Nitrates as N	10	Health
Selenium	0.01	Health
Silver	0.05	Cosmetic
Sodium ^d	--	Health
Bacteriological		
Total coliforms, MPN/100 mL	1	Disease
Pesticides, mg/L		
Endrin	0.0002	Health
Lindane	0.004	Health
Methoxychlor	0.1	Health
Toxaphene	0.005	Health
2,4-D	0.1	Health
2,4,5-TP	0.01	Health

- a. The latest revisions to the constituents and concentrations should be used.
- b. Five mg/L of suspended solids may be substituted if it can be demonstrated that it does not interfere with disinfection.
- c. Dependent on ambient air temperature; higher limits for lower temperatures.
- d. Ground water drinking supplies must be monitored at least once every 3 years; surface water supplies must be monitored at least annually.

For SR systems, individual states often have additional, crop-specific preapplication treatment requirements. These requirements are usually based on the method of wastewater application, the degree of public contact with the site, and the disposition of the crop. For example, crops for human consumption generally require higher levels of preapplication treatment than forage crops.

Local and state water quality requirements may also apply to site runoff. Generally, all wastewater runoff must be contained onsite and reapplied or treated. Stormwater runoff requirements will vary from site to site and will depend on

the expected quality of the runoff and the quality of local surface waters. State and local water quality agencies should be contacted for more specific requirements.

2.2.1.3 Regional Characteristics

Critical regional parameters include climate, surface water hydrology and quality, and ground water quality.

Climate

Local climate may affect (1) the water balance (and thus the acceptable wastewater hydraulic loading rate), (2) the length of the growing season, (3) the number of days per year that a land treatment system cannot be operated, (4) the storage capacity requirement, (5) the loading cycle of RI systems, and (6) the amount of stormwater runoff. For this reason, local precipitation, evapotranspiration, temperature, and wind values must be determined before design criteria can be established. Whenever possible, at least 10 years of data should be used to obtain these values.

Three publications of The National Oceanic and Atmospheric Administration (NOAA) provide sufficient data for most communities. The Monthly Summary of Climatic Data provides basic information, including total precipitation, temperature maxima and minima, and relative humidity, for each day of the month and every weather station in a given area. Whenever available, evaporation data are included. An annual summary of climatic data, entitled Local Climatological Data, is published for a small number of major weather stations. Included in this publication are the normals, means, and extremes of all the data on record to date for each station. The Climate Summary of the United States provides 10 year summaries of the monthly climatic data. Other data included are:

- Total precipitation for each month of the 10 year period.
- Mean number of days that precipitation exceeded 0.25 and 1.3 cm (0.10 and 0.50 in.) during each month
- Total snowfall for each month of the period
- Mean temperature for each month of the period
- Mean daily temperature maxima and minima for each month

- Mean number of days per month that the temperature was less than or equal to 0 °C (32 °F) or greater than or equal to 32.5 °C (90 °F)

A fourth reference that can be helpful is EPA's Annual and Seasonal Precipitation Probabilities [9]. This publication includes precipitation probabilities for 93 stations throughout the United States.

Data requirements for planning purposes are summarized in Table 2-5. The amount of water lost by evapotranspiration should also be estimated, either by using pan evaporation data supplied by NOAA or by using theoretical methods (Section 4.3.2.3). The length of the growing season for perennial crops is usually assumed to be the number of continuous days per year that the maximum daily temperature is above freezing. Specific information on growing seasons can also be obtained from the local county agent.

TABLE 2-5
SUMMARY OF CLIMATIC ANALYSES

Factor	Data required	Analysis	Use
Precipitation	Annual average, maximum, minimum	Frequency	Water balance
Rainfall storm	Intensity, duration	Frequency	Runoff estimate
Temperature	Days with average below freezing	Frost free period	Storage, treatment efficiency, crop growing season
Wind	Velocity, direction	--	Cessation of sprinkling
Evapotranspiration	Annual, monthly average	Annual distribution	Water balance

Surface Water Hydrology

For SR systems (see Chapter 4 for details) best management practices for control of stormwater should be used. Contour planting (instead of straight-row planting) and incorporating plant residues into the soil to increase the soil organic content will also minimize sediment and nutrient losses. When designing drainage and runoff collection systems, a 10 year return event should be the minimum interval considered.

Ground Water Hydrology

Information that should be obtained includes soil surveys, geologic and ground water resources surveys, well drilling logs, ground water level measurements, and chemical analyses of the ground water. Numerous federal, state, county, and city agencies have this type of information as well as universities, professional and technical societies, and private

concerns with ground water related interests. Particularly good sources are the U.S. Geological Survey (USGS), state water resources departments, and county water conservation and flood control districts. Much of the information collected from these agencies and entities will also be useful during the site identification step. (Figure 2-1).

2.2.2 Land Treatment System Suitability

Factors that should be considered in determining suitability of a particular land treatment process are:

- Process ability to meet treatment requirements (refer to Chapter 1)
- Study area characteristics that may dictate or eliminate certain land treatment processes
- Secondary project objectives, such as a desire for increased water supplies for irrigation or recreation

Once a preliminary decision regarding process suitability has been made, typical hydraulic and nutrient loading rates can be used to estimate land area. Minimum preapplication treatment, storage, and other requirements are then determined, and the feasibility of each type of land treatment process is evaluated.

2.2.2.1 Process Loading Rates

Slow Rate Process

The amount of wastewater that can be applied to a given SR site per unit area and per unit time is the wastewater hydraulic loading rate, which can be estimated by using the following water balance equation:

$$\begin{aligned} \text{Precipitation} + \text{applied wastewater} & & (2-1) \\ & = \text{evapotranspiration} + \text{percolation} \end{aligned}$$

Runoff is not included in the equation since SR design is based on having no runoff of applied wastewater. The percolation rate is the volume of water that must travel through the soil, per unit application area and unit time, and is established during system design. To ensure that there is no runoff, the design percolation rate should never exceed the saturated hydraulic conductivity, or permeability, of the most restrictive layer in the soil profile (i.e., the minimum soil permeability). Potential evapotranspiration values have been calculated for various locations in the

United States. These evapotranspiration values have been used along with local precipitation records to plot the difference between potential evapotranspiration and precipitation as a function of location [10]. This plot, included as Figure 2-2, can be used to determine rough estimates of the difference between evapotranspiration and precipitation at any site in the mainland United States.

Experience has shown that the maximum design percolation rate should equal no more than a fraction of the minimum soil permeability or hydraulic conductivity measured with clear water and using typical field and laboratory procedures (Sections 3.4 and 3.5). For planning purposes, the fraction ranges from about 4 to 10% of the minimum hydraulic conductivity depending on the uniformity of the soil and the degree of conservativeness (Sections 4.5.1, 5.4.1). Based on this relationship, the recommended maximum percolation rate is plotted in Figure 2-3 as a function of minimum soil permeability as measured with clear water. To use the plot during Phase 1, soil permeability must be estimated from soil survey information. Then, the range of recommended maximum percolation rates is read from the graph. The recommended range of annual wastewater hydraulic loading rates is estimated using Equation 2-1, by adding the difference between evapotranspiration and precipitation (taken from Figure 2-2) to the range of percolation rates identified in Figure 2-3. During Phase 2, hydraulic conductivity measurements should be conducted at selected sites and used to estimate maximum percolation rates.

The range of percolation rates that have been used in practice is broader than the maximum recommended range shown in Figure 2-3. The range is greater because parameters other than soil hydraulic capacity, such as nitrogen loading, crop requirements, and climate, often limit the allowable percolation rate of SR systems. For preliminary planning purposes, loading rates and land requirements are estimated by assuming that corn or sorghum or forage grasses will be grown. Nitrogen requirements for these crops are discussed in Section 4.3.

Rapid Infiltration Process

Wastewater hydraulic loading rates for RI systems are based on the hydraulic capacity of the soil and on the underlying soil geology. During Phase 1, hydraulic capacity is estimated from soil survey data and other published sources. Then, the range of percolation rates to use during preliminary planning is read from Figure 2-3. This figure (2-3) should not be used for design.

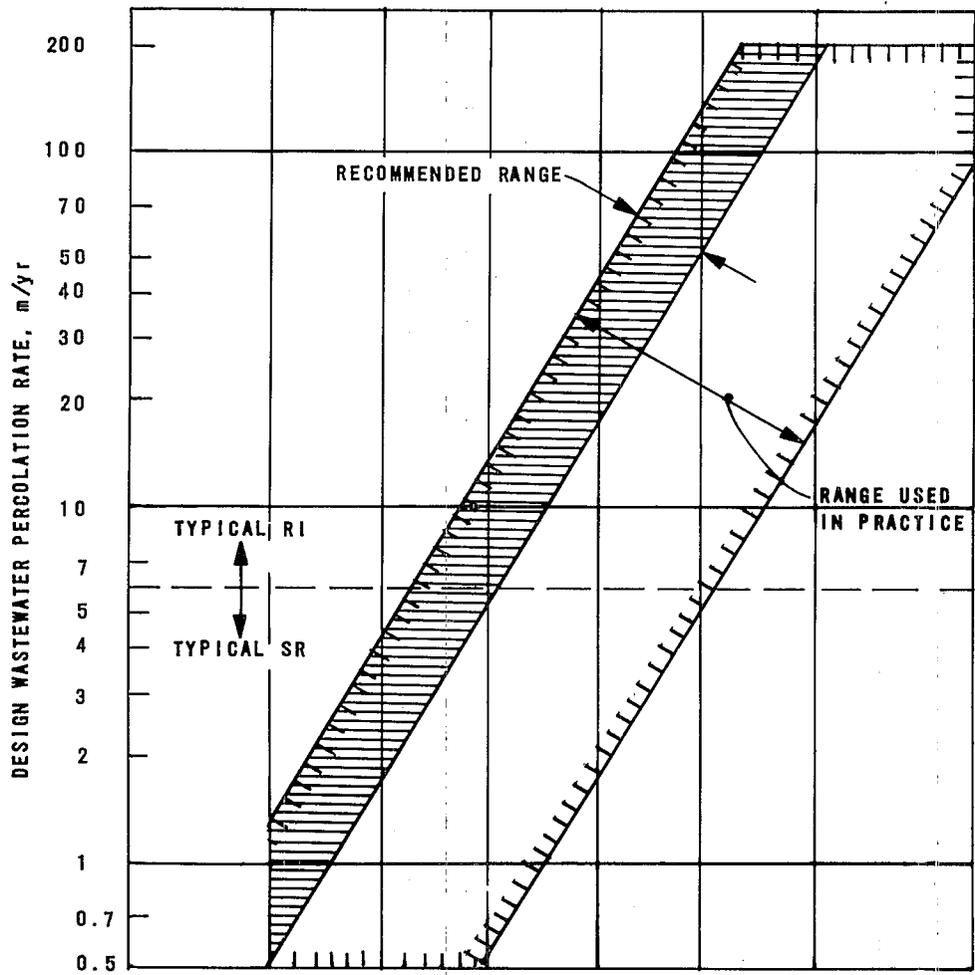

CLEAR WATER PERMEABILITY, SOIL CONSERVATION SERVICE DESCRIPTIVE TERMS							
UNITS	VERY SLOW	SLOW	MODERATE- LY SLOW	MODERATE	MODERATE- LY RAPID	RAPID	VERY RAPID
in./h	< 0.06	0.06-0.20	0.20-0.60	0.60-2.0	2.0-6.0	6.0-20.0	> 20.0
cm/h	< 0.15	0.15-0.51	0.51-1.5	1.5-5.1	5.1-15.2	15.2-50.8	> 50.8

PERMEABILITY OF MOST RESTRICTIVE LAYER IN SOIL PROFILE

FIGURE 2-3
ESTIMATED DESIGN PERCOLATION RATE AS A FUNCTION
OF SOIL PERMEABILITY FOR SR AND RI LAND TREATMENT

During Phase 2, design percolation rates are determined by measuring at least one of the following parameters:

- Infiltration rate using appropriate tests (Section 3.4)
- Hydraulic conductivity (permeability) of the soil, usually in vertical direction

As described in Section 5.4.1, the design percolation rate will always be a fraction of the test results. Considerations of nutrient removal and cold weather operation may require adjustments in the design percolation rate.

Overland Flow Process

During Phase 1 and Phase 2 planning, the engineer can assume a hydraulic loading rate of 6.3 to 20 cm/wk (2.5 to 8 in./wk) for screened raw wastewater and a rate of 10 to 25 cm/wk (4 to 10 in./wk) for primary effluent (Section 6.4). Often, OF is used to polish wastewater effluent from biological treatment processes. In such cases, assumed wastewater loading rates may be as high as 20 to 40 cm/wk (8 to 16 in./wk).

2.2.2.2 Storage Needs

For SR and OF systems, adequate storage must be provided when climatic conditions halt operations or require reduced hydraulic loading rates. Most RI basins are operated year-round, even in areas that experience cold winter weather (Figure 2-4). Rapid infiltration systems may require cold weather storage during periods when the temperature of the wastewater to be applied is near freezing and the ambient air temperature at the site is below freezing. Generally, the problem occurs only when ponds are used for preapplication treatment. Land treatment systems also may need storage for flow equalization, system backup and reliability, and system management, including crop harvesting (SR and OF) and spreading basin maintenance (RI). Reserve application areas can be used instead of storage for these system management requirements.

During the planning process, Figure 2-5 may be used to obtain a preliminary estimate of storage needs for SR and OF systems. This figure was developed from data collected and analyzed by the National Climatic Center in Asheville, North Carolina. The data were used to develop computer programs that estimate site specific wastewater storage requirements based on climate [11], which, in turn, were used to plot Figure 2-5. The map is based on the number of freezing days

per year corresponding to a 20 year return period. If application rates are reduced during cold weather, additional storage may be required. Should there be a need for more detailed data, the engineer should contact:

Director
National Climatic Center
Federal Building
Asheville, North Carolina 28801
(704) 258-2850

Any communications should refer to computer programs EPA-1, 2, and 3 (Section 4.6.2 and Appendix F). Each of these programs costs \$225 for an initial computer run (January 1981).



FIGURE 2-4
WINTER OPERATION OF RAPID INFILTRATION
AT LAKE GEORGE, NEW YORK

Alternatively, for OF and SR systems, -4°C (25°F) can be assumed as the minimum temperature at which a system will successfully operate. Readily available temperature data

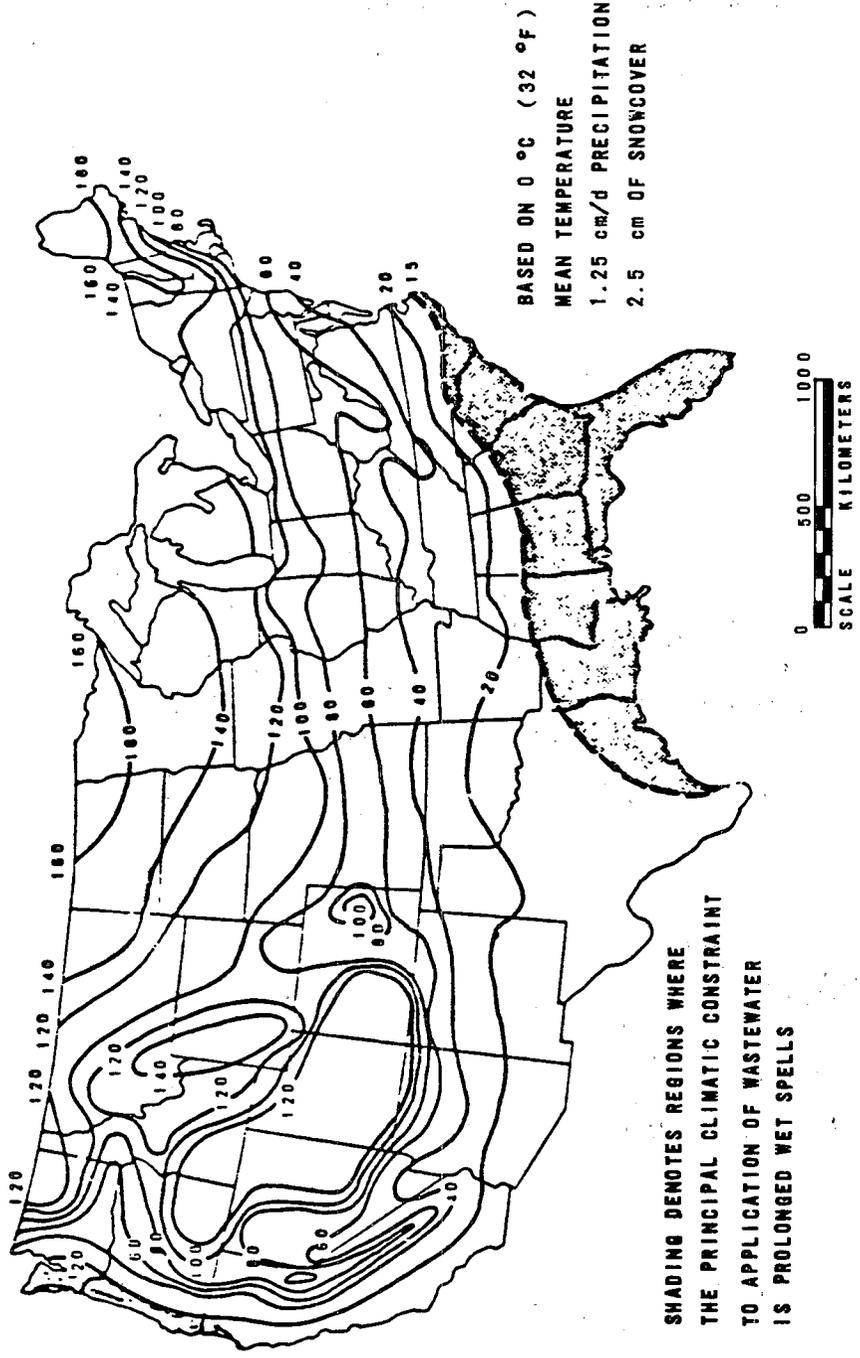

FIGURE 2-5
 ESTIMATED WASTEWATER STORAGE DAYS BASED ONLY ON CLIMATIC FACTORS [11]

may be used by assuming that systems do not operate below -4°C . Then, the required storage volume is estimated from the average cold weather flow and the number of days in which the mean temperature is less than -4°C .

2.2.3 Land Area Requirements

The amount of land required for a land treatment system includes the area needed for buffer zones, preapplication treatment, storage, access roads, pumping stations, and maintenance and administration buildings, in addition to the land actually required for treatment. Depending on growth patterns in the study area, and on the accessibility of the land treatment site, additional land may be required for future expansion or for plant emergencies.

During planning, the total amount of land required, excluding any buffer zones that may be required by state agencies, can be roughly approximated from Figure 2-6. To use the nomograph shown in this figure, the design wastewater flow must be known. First, the wastewater hydraulic loading rate is estimated (Section 2.2.2). Then, the wastewater flow and hydraulic loading rate are located on the appropriate axes and a line is drawn passing through them to the pivot line. Next, the number of weeks per year that the system will not operate, due to weather, crop harvesting, or other reasons, is estimated. A second line is drawn from the pivot point to the number of nonoperating weeks. The point at which this second line crosses the axis labeled "total area" corresponds to the estimated required area.

2.2.4 Site Identification

Potential land treatment sites are identified using existing soils, topography, hydrogeology, and land use data, shown by parameter on individual study area maps. Eventually, the data are combined into composite study area maps that indicate areas of high, moderate, and low land treatment suitability.

Potential land treatment sites are identified using a deductive approach [13]. First, any constraints that might limit site suitability are identified. In most study areas, all land within the area should be evaluated for each land treatment process. The next step is to classify broad areas of land near the area where wastewater is generated according to their land treatment suitability. Factors that should be considered include current and planned land use, topography, and soils.

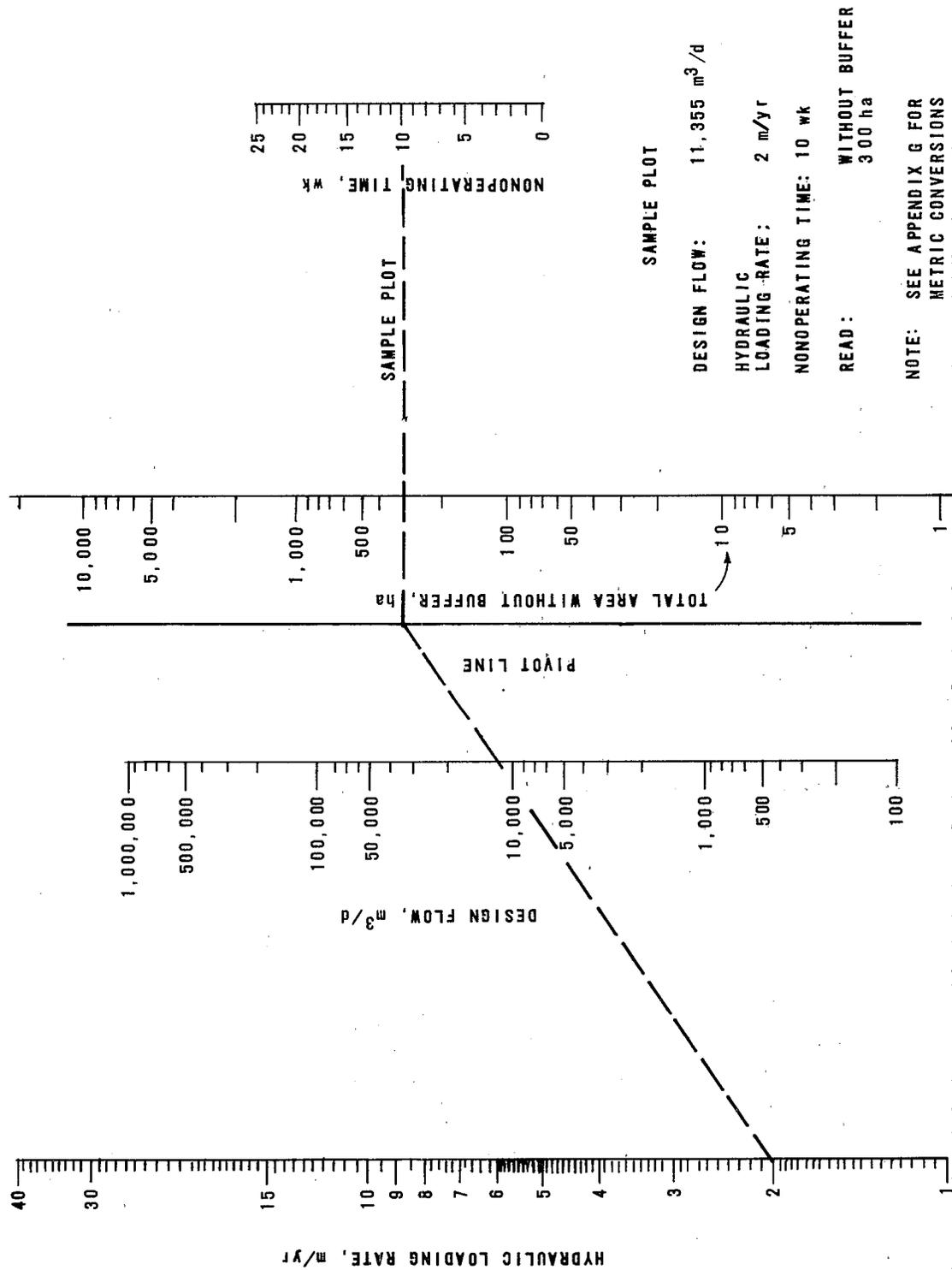

FIGURE 2-6
TOTAL LAND REQUIREMENT (INCLUDES LAND FOR APPLICATION, ROADS, STORAGE, AND BUILDINGS)

2.2.4.1 Land Use

Land use in most communities is regulated by local, county, and regional zoning laws. Land treatment systems must comply with the appropriate zoning regulations. For this reason, the planner should be fully aware of the actual land uses and proposed land uses in the study area. The planner should attempt to develop land treatment alternatives that conform to local land use goals and objectives.

Land treatment systems can conform with the following land use objectives:

- Protection of open space that is used for land treatment
- Production of agricultural or forest products using renovated water on the land treatment site
- Reclamation of land by using renovated water to establish vegetation on scarred land
- Augmentation of parklands by irrigating such lands with renovated water
- Management of flood plains by using flood plain areas for land treatment, thus precluding land development on such sites
- Formation of buffer areas around major public facilities, such as airports

To evaluate present and planned land uses, city, county, and regional land use plans should be consulted. Because such plans often do not reflect actual current land use, site visits are recommended to determine existing land use. Aerial photographic maps may be obtained from the Soil Conservation Service (SCS) or the local assessor's office. Other useful information may be available from the USGS and the EPA, including true color, false color infrared, and color infrared aerial photos of the study area.

Once the current and planned land uses have been determined, they should be plotted on a study area map. Then, land use suitability may be plotted using the factors shown in Table 2-6.

Both land acquisition procedures and treatment system operation are simplified when few land parcels are involved and contiguous parcels are used. Therefore, parcel size is an important parameter. Usually, information on parcel size

can be obtained from county assessor or county recorder maps. Again, the information should be plotted on a map of the study area.

TABLE 2-6
LAND USE SUITABILITY FACTORS FOR
IDENTIFYING LAND TREATMENT SITES [14]

Land use factor	Type of system			
	Agricultural slow rate	Forest slow rate	Overland flow	Rapid infiltration
Open or cropland	High	Moderate	High	High
Partially forested	Moderate	Moderately high	Moderate	Moderate
Heavily forested	Low	High	Low	Low
Built upon (residential, commercial, or industrial)	Low	Very low	Very low	Very low

2.2.4.2 Topography

Steep grades limit a site's potential because the amount of runoff and erosion that will occur is increased, crop cultivation is made more difficult, if not impossible, and saturation of steep slopes may lead to unstable soil conditions. The maximum acceptable grade depends on soil characteristics and the land treatment process used (Table 1-2).

Grade and elevation information can be obtained from USGS topographic maps, which usually have scales of 1:24,000 (7.5 minute series) or 1:62,500 (15 minute series). Grade suitability may be plotted using the criteria listed in Table 2-7.

TABLE 2-7
GRADE SUITABILITY FACTORS FOR IDENTIFYING
LAND TREATMENT SITES [14]

Grade factor	Slow rate systems		Overland flow	Rapid infiltration
	Agricultural	Forest		
0 to 12%	High	High	High	High
12 to 20%	Low	High	Moderate	Low
>20%	Very low	Moderate	Eliminate	Eliminate

Relief is another important topographical consideration and is the difference in elevation between one part of a land treatment system and another. The primary impact of relief is its effect on the cost of conveying wastewater to the land application site. Often, the economics of pumping wastewater to a nearby site must be compared with the cost of constructing gravity conveyance to more distant sites.

A site's susceptibility to flooding also can affect its desirability. The flooding hazard of each potential site should be evaluated in terms of both the possible severity and frequency of flooding as well as the areal extent of flooding. In some areas, it may be preferable to allow flooding of the application site provided offsite storage is available. Further, crops can be grown in flood plains if flooding is infrequent enough to make farming economical.

Overland flow sites can be located in flood plains provided they are protected from direct flooding which could erode the slopes. Backwater from flooding, if it does not last more than a few days, should not be a problem. Flood plain sites for RI basins should be protected from flooding by the use of levees.

Summaries of notable floods and descriptions of severe floods are published each year as the USGS Water Supply Papers. Maps of certain areas inundated in past floods are published as Hydrologic Investigation Atlases by the USGS. The USGS also has produced more recent maps of flood prone areas for many regions of the county as part of the Uniform National Program for Managing Flood Losses. These maps are based on standard 7.5 minute (1:24,000) topographic sheets and identify areas that lie within the 100 year flood plain. Additional information on flooding susceptibility is available from local offices of the U.S. Army Corps of Engineers and local flood control districts.

2.2.4.3 Soils

Common soil-texture terms and their relationship to the SCS textural class names are listed in Table 2-8.

Fine-textured soils do not drain well and retain water for long periods of time. Thus, infiltration is slower and crop management is more difficult than for freely drained soils such as loamy soils. Fine-textured soils are best suited for the OF process. Loamy or medium-textured soils are desirable for the SR process, although sandy soils may be used with certain crops that grow well in rapidly draining soils. Soil structure and soil texture are important characteristics that relate to permeability and acceptability

for land treatment. Structure refers to the degree of soil particle aggregation. A well structured soil is generally more permeable than unstructured material of the same type. The RI process is suited for sandy or loamy soils.

TABLE 2-8
SOIL TEXTURAL CLASSES AND GENERAL TERMINOLOGY
USED IN SOIL DESCRIPTIONS

General terms		Basic soil textural class names
Common name	Texture	
Sandy soils	Coarse	Sand Loamy sand
	Moderately coarse	Sandy loam Fine sandy loam
Loamy soils	Medium	Very fine sandy loam Loam Silt loam Silt
	Moderately fine	Clay loam Sandy clay loam Silty clay loam
Clayey soils	Fine	Sandy clay Silty clay Clay

Soil surveys are usually available from the SCS. Soil surveys normally contain maps showing soil series boundaries and textures to a depth of about 1.5 m (5 ft). The scale of these maps ranges from 1:31,680 to 1:15,840 and even 1:7,920 in some locations. In a survey, limited information on chemical properties, grades, drainage, erosion potential, general suitability for locally grown crops, and interpretive and management information is provided. In some areas, published surveys are not available or exist only as detailed reports with maps ranging in scale from 1:100,000 to 1:250,000. Additional information on soil characteristics and on soil survey availability can be obtained from the SCS, through the local county agent.

Although soil depth, permeability, and chemical characteristics significantly affect site suitability, data on these parameters are often not available before the site investigation phase. If these data are available, they should be plotted on a study area map along with soil texture. In identifying potential sites, the planner should keep in mind that adequate soil depth is needed for root development and for thorough wastewater treatment. Further, permeability requirements vary among the land treatment processes. Desirable permeability ranges are shown by process in Table 2-9 together with desired soil texture. The SCS permeability class definitions are presented in Figure 2-3.

Certain geological formations are of interest during Phase 1. Discontinuities and fractures in bedrock may cause shortcircuiting or other unexpected ground water flow patterns. Impermeable or semipermeable layers of rock, clay, or hardpan can result in perched ground water tables. The USGS and many state geological surveys have maps indicating the presence and effects of geological formations. These maps and other USGS studies may be used to plot locations within the study area where geological formations may limit the suitability for land treatment.

TABLE 2-9
TYPICAL SOIL PERMEABILITIES AND TEXTURAL
CLASSES FOR LAND TREATMENT PROCESSES

	Principal processes		
	Slow rate	Rapid infiltration	Overland flow
Soil permeability range, cm/h	>0.15	>5.0	<0.5
Permeability class range	Moderately slow to moderately rapid	Rapid	Slow
Textural class range	Clay loams to sandy loams	Sand and sandy loams	Clays and clay loams
Unified Soil Classification	GM-d, SM-d, ML, OL, MH, PT	GW, GP, SW, SP	GM-u, GC, SM-u, SC, CL, OL, CH, OH

Once each of the parameters discussed in the preceding paragraphs have been mapped, the maps are merged into a composite map that indicates areas with high, moderate, and low suitability. Map overlays may be useful during this process.

2.2.5 Site Screening

During the latter half of Phase 1, each part of the study area that appears to be suitable for land treatment must be evaluated and rated in terms of technical suitability and feasibility. Rating is often accomplished by weighting each of the site selection factors and using a numerical system. The resulting ratings are used to identify sites that have high overall suitability and that should be investigated more thoroughly. If suitable sites are not available, no further consideration is given to land treatment.

Site selection factors and weightings should vary to suit the needs and characteristics of the community. Several factors that should be considered are listed in Table 2-10. A sample rating system is shown in Table 2-11. This system may be varied by the planner to reflect available information.

TABLE 2-10
SITE SELECTION GUIDELINES

Characteristic	Process	Remarks
Soil permeability	Overland flow	High permeability soils are more suitable to other processes.
	Rapid infiltration and slow rate	Hydraulic loading rates increase with permeability.
Potential ground water pollution	Rapid infiltration and slow rate	Affected by the (1) proximity of the site to a potential potable aquifer, (2) presence of an aquiclude, (3) direction of ground water flow, and (4) degree of ground water recovery by wells or underdrains.
Ground water storage and recovery	Rapid infiltration	Capability for storing percolated water and recovery by wells or underdrains is based on aquifer depth, permeability, aquiclude continuity, effective treatment depth, and ability to contain the recharge mound within the defined area.
Existing land uses	All processes	Involves the occurrence and nature of conflicting land use.
Future land use	All processes	Future urban development may affect the ability to expand the system.
Size of site	All processes	If there are a number of small parcels, it is often difficult to purchase or lease the needed area.
Flooding hazard	All processes	May exclude or limit site use.
Slope	All processes	Steep grades may (1) increase capital expenditures for earthwork, and (2) increase the erosion hazard during wet weather.
	Rapid infiltration	Steep grades often affect ground water flow pattern.
	Overland flow	Steep grades reduce the travel time over the treatment area and treatment efficiency. Flat land requires extensive earthwork to create grades.
Water rights	All processes	May require disposal of renovated water in a particular watershed within a particular stretch of surface water.

TABLE 2-11
RATING FACTORS FOR SITE SELECTION [14, 15]

Characteristic	Slow rate systems		Overland flow	Rapid infiltration
	Agricultural	Forest		
Soil depth, m ^a				
0.3-0.6	E ^b	E	0	E
0.6-1.5	3	3	4	E
1.5-3.0	8	8	7	4
>3.0	9	9	7	8
Minimum depth to ground water, m				
<1.2	0	0	2	E
1.2-3.0	4	4	4	2
>3.0	6	6	6	6
Permeability, cm/h ^c				
<0.15	1	1	10	E
0.15-0.5	3	3	8	E
0.5-1.5	5	5	6	1
1.5-5.0	8	8	1	6
>5.0	8	8	E	9
Grade, %				
0-5	8	8	8	8
5-10	6	8	5	4
10-15	4	6	2	1
15-20	0	5	E	E
20-30	0	4	E	E
30-35	E	2	E	E
>35	E	0	E	E
Existing or planned land use				
Industrial	0	0	0	0
High density residential/urban	0	0	0	0
Low density residential/urban	1	1	1	1
Forested	1	4	1	1
Agricultural or open space	4	3	4	4
Overall suitability rating ^d				
Low	<15	<15	<16	<16
Moderate	15-25	15-25	16-25	16-25
High	25-35	25-35	25-35	25-35

Note: The higher the maximum number in each characteristic, the more important the characteristic; the higher the ranking, the greater the suitability.

- a. Depth of the profile to bedrock.
- b. Excluded; rated as poor.
- c. Permeability of most restrictive layer in soil profile.
- d. Sum of values.

**EXAMPLE 2-1: USE OF RATING FACTORS TO DETERMINE
SITE SUITABILITY**

An example of the use of rating factors is presented in the following two figures and tables. Example soil types are shown in Figure 2-7 as presented in a portion of a county SCS soil survey. Characteristics of the three soil types and existing land uses are presented in Table 2-12. The characteristics are then compared to the rating factors in Table 2-11 to obtain the numerical values in Table 2-13. For example, the Bibb silt loam in Table 2-12 has a depth of soil above bedrock of 1.5 to 3 m (5 to 10 ft). From Table 2-11, this would correspond to values of 8 for SR, 7 for OF, and 4 for RI. These values are entered into Table 2-13.

When all factors are evaluated, the numerical values are added together to obtain a total and to determine the suitability rating. The high suitability areas are presented in the soils map in Figure 2-8. By applying this procedure to all soils within a given radius of the community, the most suitable sites (generally 3 to 5) are identified for further field investigation and cost-effectiveness evaluation.

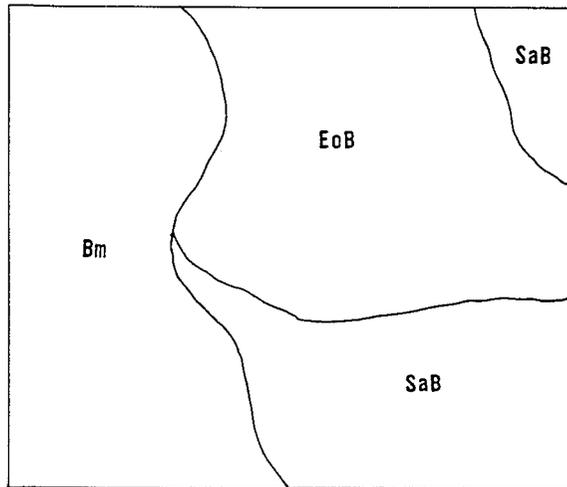

**FIGURE 2-7
EXAMPLE AREA OF SOIL MAP TO BE EVALUATED**

**TABLE 2-12
CHARACTERISTICS OF SOIL SERIES MAPPED IN FIGURE 2-7**

	Bibb silt loam	Sassafras fine sandy loam	Evesboro loamy sand
Map symbol	Bm	SaB	EoB
Soil depth, m	1.5-3.0	0.6-1.5	>3.0
Depth to ground water, m	<1.2	1.2-3.0	1.2-3
Permeability, cm/h	<0.15	1.5-5.0	>5.0
Grade, %	0-5	0-5	0-5
Land use	Agricultural	Forested	Industrial

TABLE 2-13
EXAMPLE USE OF RATING FACTORS FOR SITE SELECTION

Soil type	System type	Depth	Ground water	Permeability	Grade	Land use	Total	Suitability
Bibb	SR	8	0	1	8	4	21	Moderate
silt loam (Bm)	OF	7	2	10	8	4	31	High
	RI	4	E	E	8	4	-- ^a	Eliminate
Sassafras	SR	2	4	8	8	1	24	Moderate
fine sandy loam (SaB)	OF	4	4	1	8	1	18	Moderate
	RI	E	2	6	8	1	-- ^a	Eliminate
Evesboro	SR	9	4	8	8	0	29	High
loamy sand (EoB)	OF	7	4	E	8	0	-- ^a	Eliminate
	RI	8	2	9	8	0	27	High

a. Total not determined because site was clearly eliminated (E) for this type of land treatment based on one or more site factors.

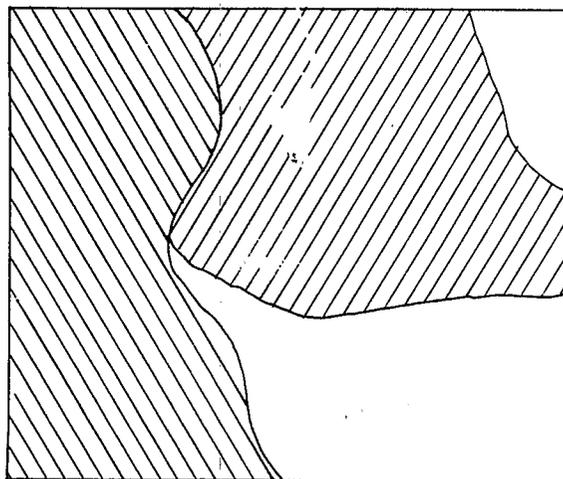

-  SR or RI HIGH SUITABILITY
-  OF HIGH SUITABILITY
SR MODERATE SUITABILITY
-  SR or OF MODERATE SUITABILITY

FIGURE 2-8
EXAMPLE SUITABILITY MAP FOR SOILS IN FIGURE 2-7

2.3 Phase 2 Planning

Phase 2, the site investigation phase, occurs only if sites with potential have been identified in Phase 1. During Phase 2, field investigations are conducted at the selected sites to determine whether land treatment is technically feasible. When sufficient data have been collected, preliminary design criteria are calculated for each potential site. Using these criteria, capital and operation and maintenance costs are estimated. These cost estimates and other nonmonetary factors are used to evaluate the sites selected during Phase 1 for cost effectiveness. On the basis of this evaluation, a land treatment alternative is selected for design.

2.3.1 Field Investigations

Field investigations that should be performed during Phase 2 include:

- Characterization of the soil profile to an approximate depth of 1.5 m (5 ft) for SR, 3 m (10 ft) for RI, and 1 m (3 ft) for OF
- Measurements of ground water depth, flow, and quality
- Infiltration rate and soil hydraulic conductivity measurements
- Determination of soil chemical properties

Methods for these analyses are detailed in Chapter 3.

2.3.2 Selection of Preliminary Design Criteria

From information collected during the field investigations, the engineer can confirm the suitability of the sites for the identified land treatment process(es). Using the loading rates described previously (Figure 2-3, Section 2.2.2), the engineer should then select the appropriate hydraulic loading rate for each land treatment process that is suitable for each site under consideration. Based on the loading rate estimates, land area, preapplication treatment, storage, and other system requirements can be estimated. Reuse/recovery options should also be outlined at this time.

2.3.2.1 Preapplication Treatment

Some degree of wastewater treatment prior to land application is usually necessary, for one or more of the following reasons:

- To avoid unnecessary wear on the distribution system, and in particular, pumps in the system
- To allow wastewater storage prior to land treatment without creating nuisance conditions
- To minimize potential public health risks
- To reduce soil clogging in RI land treatment
- To obtain a higher overall level of wastewater treatment

Industrial pretreatment should be considered when industrial waste contains materials that (1) could hinder the treatment processes; (2) could accumulate in quantities that would be detrimental to the soil-plant system; or (3) could pass through a land treatment system and restrict the beneficial uses of the renovated water or the native ground water. Industrial contaminants of concern include trace organics and trace elements. General guidelines and time schedules for implementation of industrial waste pretreatment programs can be obtained from the EPA regional offices.

2.3.2.2 Recovery of Renovated Water

The collection of renovated wastewater following land treatment may be either necessary or desirable. If the renovated wastewater can be reclaimed for beneficial uses, recovery may even be profitable. In many locations, water rights may necessitate recovery of renovated water for disposal at a specific location in a given watershed. In some locations, underdrainage may be needed to control ground water elevations and allow site development.

Methods used to recover renovated wastewater include underdrains, recovery wells, surface runoff collection, and tailwater return. Wastewater can also be recovered through springs and seeps that result from land treatment or by subsurface flow from the land treatment site to the surface water. These methods and their applicability to each of the three major types of land treatment are summarized in Table 2-14. Design of recovery systems is discussed in more detail in Chapters 4, 5, and 6.

TABLE 2-14
 APPLICABILITY OF RECOVERY SYSTEMS FOR RENOVATED WATER

Recovery system	Slow rate	Rapid infiltration	Overland flow
Springs, seeps, or natural drainage	Often used to maintain water rights	Often used to maintain water rights	NA
Underdrains	Ground water control and effluent reuse	Ground water control and effluent reuse	NA
Recovery wells	Usually NA	Ground water control and effluent reuse	NA
Surface runoff			
Effluent	NA	NA	Collect, discharge ^a
Stormwater	Sediment control	NA	Collect, discharge ^a
Tailwater			
Sprinkler application	NA	NA	NA
Surface application	25-50% of applied flow	NA	NA

NA - not applicable.

a. Disinfect if required before discharge; provide for short-term recycling of wastewater after extended periods of shutdown if effluent requirements are stringent.

2.3.3 Evaluation of Alternatives

Land treatment alternatives should be evaluated on the basis of capital costs, operation and maintenance costs (including energy consumption), and other nonmonetary factors, such as public acceptability, ease of implementation, environmental impact, water rights, and treatment consistency and reliability.

2.3.3.1 Costs

For cost analyses, the EPA cost-effectiveness analysis procedures described in 40CFR 35, Appendix A, must be used in selecting any municipal wastewater management system that will be funded under PL 92-500 [16]. For nongrant funded projects, the EPA analysis may be modified to fit a community's specific objectives. The most cost-effective alternative is defined as follows [16]:

The most cost-effective alternative shall be the waste treatment management system which the analysis determines to have the lowest present worth or equivalent annual value unless nonmonetary costs are overriding. The most cost-effective alternative must also meet the minimum requirements of applicable effluent limitations, groundwater protection, or other applicable standards established under the Act.

Curves for estimating capital and operation and maintenance costs may be found in reference [17], or the CAPDET system can be used for a preliminary estimate.

Cost comparisons should include the cost of preapplication treatment and sludge handling as well as land treatment process components, including transmission, storage, field preparation, renovated water recovery, and land. The costs of resolving any water rights problems also must be included. The EPA cost-effectiveness guidelines require that grant-funded projects use the following general service lives:

- | | |
|-----------------------|----------------|
| ● Land | Permanent |
| ● Structures | 30 to 50 years |
| ● Process equipment | 15 to 30 years |
| ● Auxiliary equipment | 10 to 15 years |

Capital costs for land will vary from site to site. Land treatment systems must have adequate land for preapplication treatment facilities, storage reservoirs, wastewater application, buffer zones, administrative and laboratory buildings, transmission pipe easement, and other facilities. Costs of relocating residences and other buildings depend on the location but also should be included in capital cost estimates. The local offices of the U.S. Army Corps of Engineers, U.S. Bureau of Reclamation, and state highway departments can provide information on relocation cost estimates.

Several options are available for acquisition or control of the land used for wastewater application, including:

- Outright purchase (fee-simple acquisition)
- Long-term lease or easement
- Purchase and leaseback of land (usually to farmer for irrigation) with no direct municipal involvement in land management.

For larger projects, fee-simple land acquisition is favored by most federal agencies, states, and communities. Further, outright purchase provides the highest degree of control over the land application site and ensures uninterrupted land availability. Estimates indicate that land leasing has been cost effective for several hundred projects nationwide. Generally, these projects are in arid or semi-arid areas where renovated water has a high value and land a relatively low value. Leasing or easement arrangements also can be very attractive for smaller communities.

Capital costs of land for both land treatment processes and storage prior to land application are eligible for federal Construction Grants Program funding as specified in EPA guidance [18]. During the cost effectiveness analyses, the engineer must keep in mind that, unlike many other treatment components, land has a salvage value. In addition, current EPA guidance allows the land value to appreciate 3% per year. Thus, the salvage value after 20 years is:

$$(1 + 0.03)^{20} \times \text{present price} = (1.806)(\text{present price})$$

The present worth of this salvage value is calculated using the prevailing interest rate, not the 3% appreciation rate. Long-term easements or leases of land for land application processes also are eligible for Construction Grants Program funding, provided that the conditions summarized in Table 2-15 are met.

TABLE 2-15
LEASE/EASEMENT REQUIREMENTS FOR CONSTRUCTION
GRANTS PROGRAM FUNDING [18]

-
- Limit the purpose of the lease or easement to land application and activities incident to land application.
 - Describe explicitly the property use desired.
 - Waive the landowner's right to restoration of the property at the termination of the lease/easement.
 - Recognizing the serious risk of premature lease termination, provide for full recovery of damages by the grantee in such an event. The grantee must insure the capability to operate and meet permit requirements for the useful life of the project.
 - Provide for payment of the lease/easement in a lump sum for the full value of the entire term.
 - Provide for leases/easements for the useful life of the treatment plant, with an option of renewal for additional terms, as deemed appropriate.
-

Operation and maintenance costs include labor, materials, and supplies (including chemicals), and power costs. For cost comparison purposes, they are assumed to be constant

during the planning period. However, if average wastewater flows are expected to increase significantly during the planning period, operation and maintenance costs should be developed for each year of the planning process. Operation and maintenance cost curves may be found in references [17, 19].

To estimate labor costs, staffing requirements for both preapplication treatment and land treatment must be determined. Staffing requirements for preapplication treatment can be found in reference [19]. Staffing requirements at municipally owned and operated land treatment systems have been plotted as a function of flow in Figure 2-9. Land treatment systems that are owned and/or operated by farmers will have lower municipal staffing requirements.

Annual costs should include the cost of leasing land for wastewater application, when appropriate. Annual cost estimates also should take into consideration revenues from crop sales, sale of renovated water, sale of effluent for land application, or leaseback of purchased land for farming or other purposes. Because of the uncertainty in estimating these revenues, they should be used to offset only a portion of the operating costs in the cost-effectiveness analysis.

Prevailing market values for crops usually can be obtained from state university cooperative extension services. Preliminary yield estimates should be based on the proposed application conditions and on typical yields in the local area.

Another source of revenue may be the sale of recovered renovated water, particularly runoff from OF systems or renovated water from RI system recovery wells. Markets for renovated water must be investigated on a community by community basis. Methods of assessing the relative value of renovated wastewater for various uses and potential reuse categories are discussed in reference [20].

2.3.3.2 Energy

Basic energy requirements for unit processes and operations have been described and quantified in reference [21]. The data in the report were used to compare land treatment energy requirements with mechanical system requirements and to develop equations for calculating the energy requirements of each unit process [22]. Equations in Chapter 8 can be used to generate accurate power cost estimates for the cost-effectiveness analysis.

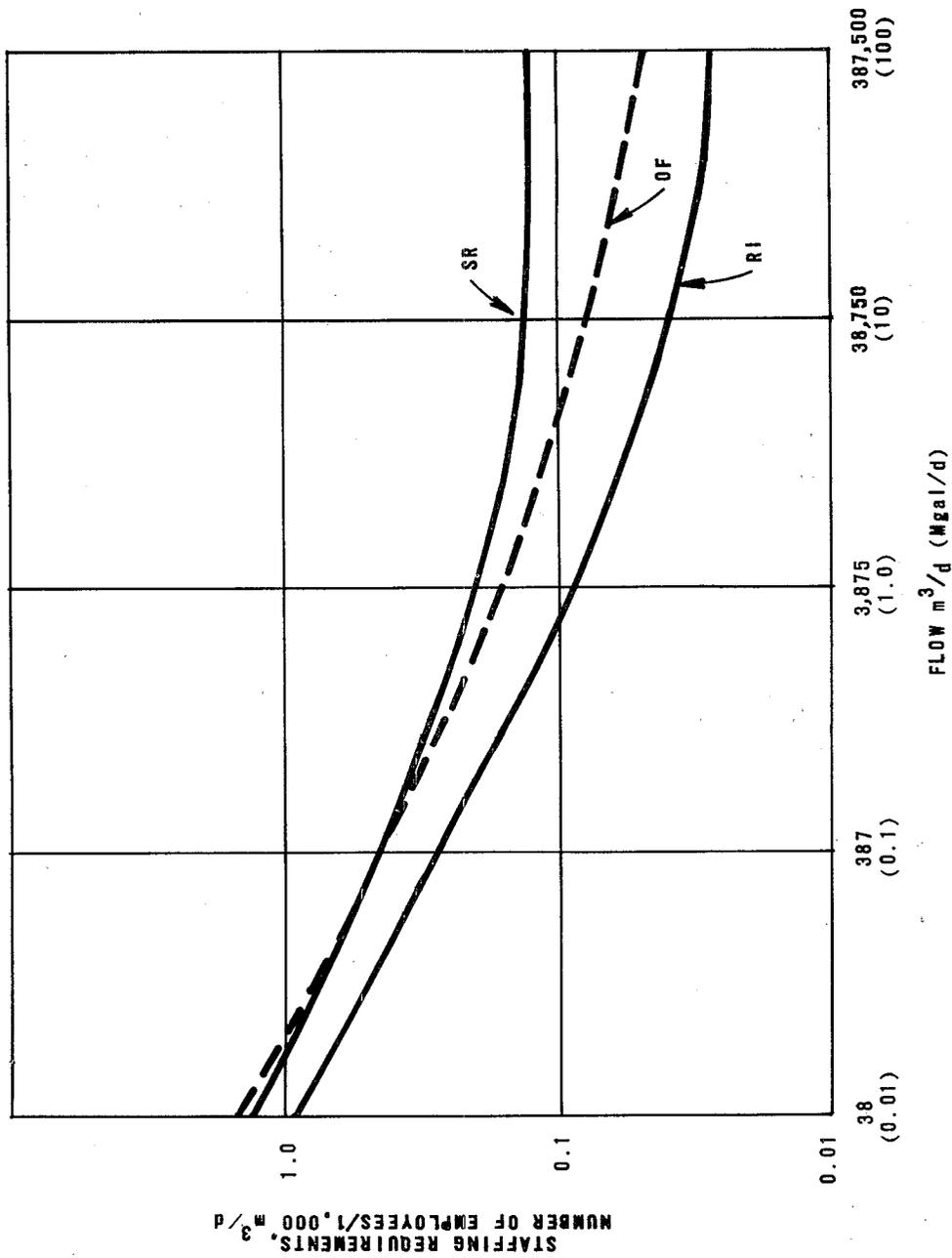

FIGURE 2-9
 STAFFING REQUIREMENTS FOR LAND TREATMENT COMPONENTS (NOT INCLUDING SEWER SYSTEM OR PREAPPLICATION TREATMENT) FOR MUNICIPALLY OWNED AND OPERATED SYSTEMS [19]

2.3.3.3 Nonmonetary Considerations

According to the EPA guidelines, a cost-effectiveness analysis must also consider nonmonetary factors such as environmental impacts [23, 24], ease of implementation (magnitude of potential water rights conflicts, public acceptability), and treatment consistency and reliability. Potential water rights conflicts are discussed briefly in Section 2.4. Public acceptability will be greatly aided by an effective public participation program, particularly if there is any chance that local farmers will be involved in an SR system. Public participation regulations in the federal Construction Grants Program are given in 40 CFR Part 35. These regulations implement the public participation requirements of 40 CFR Part 25.

Changing discharge requirements, wastewater characteristics, growth rates, and land uses for areas surrounding and contributing to the treatment system require treatment flexibility. The ability of each alternative to adapt to changes should be evaluated.

2.3.4 Plan Selection

To select an alternative, each of the factors considered during the evaluation process should be compared on an equivalent basis. Monetary factors should be expressed in terms of total present worth or equivalent annual cost. Nonmonetary factors should be weighted according to their local importance, and reasons cited for abandoning any alternative for nonmonetary reasons. If there are no overriding nonmonetary factors, the alternative selected should be the plan with the lowest total present worth or equivalent annual cost.

Actual alternative selection should involve the wastewater management agency, the planner/engineer, advisory groups, citizen and special interest groups, and other interested governmental agencies. Once an alternative is tentatively selected, and before design begins, mitigation measures for minimizing any identified adverse impacts should be outlined.

2.4 Water Rights and Potential Water Rights Conflicts

Land application of wastewaters may cause several changes in drainage and flow patterns [25]:

1. Site drainage may be affected by land preparation, soil characteristics, slope, method of wastewater application, cover crops, climate, buffer zones, and spacing of irrigation equipment.

2. Land application may alter the pattern of flow in the body of water that would have received the wastewater discharge. Although this may diminish the flow in the body of water, it also may increase the quality. The change may be continuous or seasonal.
3. Land application may cause surface water diversion, because wastewaters that previously would have been carried away by surface waters are now applied to land and often diverted to a different watershed.

Two basic types of water rights laws exist in the United States: riparian laws, which emphasize the right of riparian landowners along a watercourse to use of the water, and appropriative laws, which emphasize the right of prior users of the water [25]. Most riparian or land ownership rights are in effect east of the Mississippi River, whereas most appropriative rights are in effect west of the Mississippi River. Specific areas where these two doctrines dominate are shown in Figure 2-10.

Most states divide their water laws into three categories: (1) waters in well-defined channels or basins (natural watercourses), (2) superficial waters not in channels or basins (surface waters), and (3) underground waters not in well-defined channels or basins (percolating waters or ground waters). Potential water rights problems involving each type of water and each of the three primary types of land treatment are summarized in Table 2-16. This table is intended to aid during planning and preliminary screening of alternatives, but is not to be used as the basis for eliminating any alternatives.

2.4.1 Natural Watercourses

Most legal problems regarding natural watercourses involve the diversion of a discharge with the subsequent reduction in flow through the watercourse. In riparian states, diversion of discharges that were not originally part of a stream should not be cause for legal action. In appropriative states, if the diversion would threaten the quantity or quality of a downstream appropriation, the downstream user has cause for legal action. Legal action may be either injunctive, preventing the diverter from affecting the diversion, or monetary, requiring the diverter to compensate for the damages. If the area is not water-short and if the watercourse is not already overappropriated, damages would be difficult if not impossible to prove.

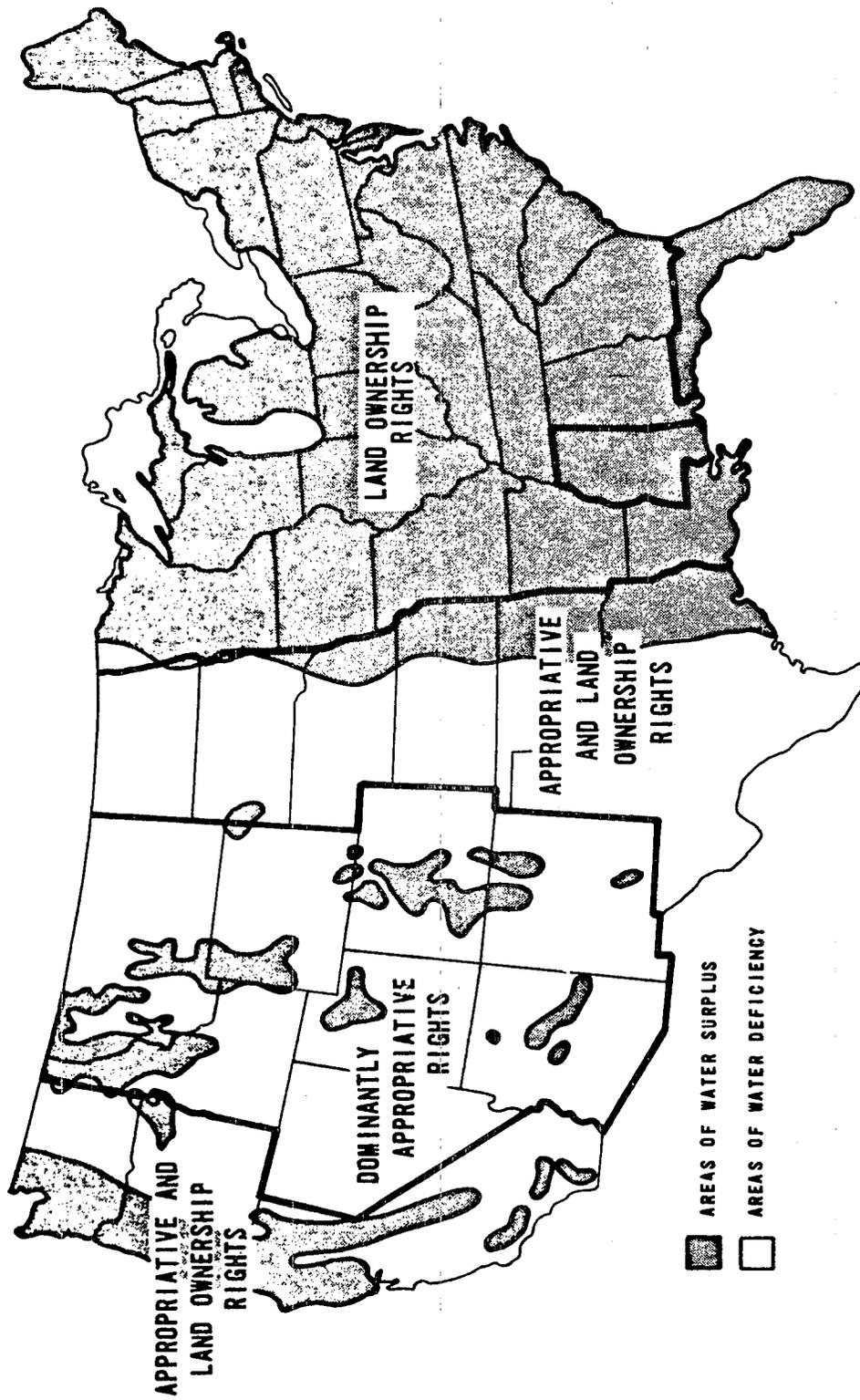

FIGURE 2-10
 DOMINANT WATER RIGHTS DOCTRINES AND AREAS OF WATER SURPLUS OR DEFICIENCY

TABLE 2-16
POTENTIAL WATER RIGHTS PROBLEMS FOR LAND
TREATMENT ALTERNATIVES^a

Water definition and water rights theory	Land treatment process		
	Slow rate	Rapid infiltration	Overland flow
Natural watercourses			
Riparian	Unlikely	Unlikely	Unlikely
Appropriative	Likely ^b	Likely ^b	Depends on location of discharge from collection ditch
Combination	Likely ^b	Likely ^b	Depends on location of discharge from collection ditch
Surface waters			
Riparian	Unlikely	Unlikely	Likely ^c
Appropriative	Unlikely	Unlikely	Likely ^c
Combination	Unlikely	Unlikely	Likely ^c
Percolating or ground waters			
Riparian	Unlikely	Possible	Unlikely
Appropriative	Likely	Likely	Unlikely
Combination	Likely	Likely	Unlikely

- a. For existing conditions and alternative formulation stage of the planning process only. It is also assumed that the appropriative situations are water-short or overappropriated.
- b. If effluent was formerly discharged to stream.
- c. If collection/discharge ditch crosses other properties to the natural watercourse.

2.4.2 Surface Waters

For surface waters, riparian and appropriative rights are very similar. If renovated water from a land treatment system crosses private property, a drainage or utility easement will be necessary.

2.4.3 Percolating Waters (Ground Waters)

Water rights conflicts may be caused either by a rise in the ground water table that damages lands adjoining a land treatment system or by the appearance of trace contaminants in nearby wells. In riparian states, the landowner must prove that his ground water is continuous with and down-gradient from ground water underlying the land treatment site. If the alleged damages are not the result of negligent treatment site operation, cause for legal action will be difficult to show. In appropriative states, increases in ground water table elevations would not usually threaten anyone's appropriative right. Thus, there would be no cause for legal action.

2.4.4 Sources of Information

For larger systems and in problem areas, the state or local water master or water rights engineer should be consulted. Other references to consider are the publications, A Summary-Digest of State Water Laws, available from the National Water Commission [25], and Land Application of Wastewater and State Water Law, Volumes I and II [26, 27]. If problems develop or are likely with any of the feasible alternatives, a water rights attorney should be consulted.

2.5 References

1. Metcalf & Eddy Inc. Wastewater Engineering, Treatment, Disposal, Reuse. Second Edition. McGraw Hill Book Company. New York, N.Y. 1979.
2. Thomas, R.E. and J.P. Law. Properties of Waste Waters. In: Soils for Management of Organic Wastes and Waste Waters. American Society of Agronomy, Madison, Wisconsin. 1977. p.47-72.
3. Davis, J.A., III, and J. Jacknow. Heavy Metals in Wastewater in Three Urban Areas. Journal WPCF, 47:2292-2297. September 1975.
4. Pound, C.E., R.W. Crites, and J.V. Olson. Long-Term Effects of Land Application of Domestic Wastewater: Hollister, California, Rapid Infiltration Site. Environmental Protection Agency, Office of Research and Development. EPA-600/2-78-084. April 1978.
5. Ketchum, B.H. and R.F. Vaccaro. The Removal of Nutrients and Trace Metals by Spray Irrigation and in a Sand Filter Bed. In: Land as a Waste Management Alternative. Loehr, R.C. (ed.) Ann Arbor, Ann Arbor Science. 1977. pp. 413-434.
6. Chen, K.Y., et al. Trace Metals in Wastewater Effluents. Journal WPCF, 46:2663-2675. December 1975.
7. National Interim Primary Drinking Water Regulations. U.S. Environmental Protection Agency. EPA-570/9-76-003. 1976.
8. Interim Primary Drinking Water Regulations; Amendments. Federal Register. 45(168):57332-57357. August 27, 1980.

9. Thomas, R.E. and D.M. Whiting. Annual and Seasonal Precipitation Probabilities. U.S. Environmental Protection Agency. EPA-600/2-77-182. August 1977.
10. Flach, K.W. Land Resources. In: Recycling Municipal Sludges and Effluents on Land. Champaign, University of Illinois. July 1973.
11. Whiting, D.M. Use of Climatic Data in Estimating Storage Days for Soil Treatment Systems. Environmental Protection Agency, Office of Research and Development. EPA-600/2-76-250. November 1976.
12. Thomas, R.E., et al. Feasibility of Overland Flow for Treatment of Raw Domestic Wastewater. U.S. Environmental Protection Agency. EPA-66/2-74-087. 1974.
13. Sills, M.A., et al. Two Phase Evaluation of Land Treatment as a Wastewater Treatment Alternative - A Rational Approach to Federal and State Planning and Design Requirements. Proceedings of the Symposium on Land Treatment of Wastewater, Hanover, New Hampshire. August 20-25, 1978.
14. Moser, M.A. A Method for Preliminary Evaluation of Soil Series Characteristics to Determine the Potential for Land Treatment Processes. Proceedings of the Symposium on Land Treatment of Wastewater. Hanover, New Hampshire. August 20-25, 1978.
15. Taylor, G.L. A Preliminary Site Evaluation Method for Treatment of Municipal Wastewater by Spray Irrigation of Forest Land. Proceedings of the Conference of Applied Research and Practice on Municipal and Industrial Waste. Madison, Wisconsin. September 10-12, 1980.
16. U.S. Environmental Protection Agency. 40 CFR 35, Appendix A, Cost-Effectiveness Analysis. September 27, 1978.
17. Reed, S.C., et al. Cost of Land Treatment Systems. U.S. Environmental Protection Agency. EPA 430/9-75-003. September 1979.
18. U. S. Environmental Protection Agency. Facilities Planning, 1982. EPA-430/9-81-012. FRD-25. September 1981.

19. Patterson, W.L. and R.F. Banker. Estimating Costs and Manpower Requirements for Conventional Wastewater Treatment Facilities. EPA 17090 DAN. October 1971.
20. Schmidt, C.J. and E.V. Clements, III. Demonstrated Technology and Research Needs for Reuse of Municipal Wastewater. U.S. Environmental Protection Agency. EPA 670/2-75-038. May 1975.
21. Wesner, E.M., et al. Energy Conservation in Municipal Wastewater Treatment. U.S. Environmental Protection Agency. EPA-430/9-77-011. March 1978.
22. Middlebrooks, E.J. and C.H. Middlebrooks. Energy Requirements for Small Flow Wastewater Treatment Systems. U.S. Army Corps of Engineers, Cold Regions Research and Engineering Laboratory. May 1979.
23. Canter, L. Environmental Impact Assessment. McGraw-Hill Book Co. New York, New York. 1977.
24. U.S. Environmental Protection Agency. Regulations for Preparation of Environmental Impact Statements. 40 CFR Part 6, Section 6.512.
25. Dewsnap, R.L. and D.W. Jensen, eds. A Summary Digest of State Water Laws. National Water Commission. Washington, D.C. May 1973.
26. Large, D.W. Land Application of Wastewater and State Water Law: An Overview (Volume I). U.S. Environmental Protection Agency. EPA-600/2-77-232. November 1977.
27. Large, D.W. Land Application of Wastewater and State Water Law: State Analyses (Volume II). U.S. Environmental Protection Agency. EPA-600/2-78-175. August 1978.

Chapter 3

FIELD INVESTIGATIONS

3.1 Introduction

In contrast to conventional technologies, the analysis and design of land treatment systems requires specific information on the properties of the proposed site or sites. Too little field data may lead to erroneous conclusions while too much will result in unnecessarily high costs with little refinement in the design concept. Experience indicates that where uncertainty exists, it is prudent to adopt a conservative posture relative to data gathering requirements.

Figure 3-1 is a flow chart which presents a logical sequence of field testing for a land treatment project. At several points, available data are used for calculations or decisions that may then necessitate additional field tests. These additional tests are usually directed toward estimation of new parameters, required for extending the analysis. However, in some cases, additional field tests may also be required simply to refine preliminary estimates.

Guidance on testing for wastewater constituents and soil properties is provided for each land treatment process in Table 3-1. Normally, relatively modest programs of field testing and data analysis will be satisfactory. In certain instances, however, more complex investigations and analyses are required with higher levels of expertise in soil testing and evaluation procedures. Firms specializing in these areas are available for assistance if expertise does not exist within the firm having general design responsibility.

3.2 Physical Properties

Preliminary screening, as described in Chapter 2, of a potential site (or sites) will ordinarily be based on existing field data available from a SCS county soil survey and other sources. The next step involves some physical exploration on the site. This preliminary exploration is of critical importance to subsequent phases of the project. Its two purposes are: (1) verification of existing data and (2) identification of probable, or possible, site limitations; and it should be performed with reasonable care. For example, the presence of wet areas, water-loving plant species, or surficial salt crusts should alert the designer to the need for detailed field studies directed toward the problem of drainage. The presence of rock outcroppings

→ TYPICAL ORDER OF TESTING

FIELD TESTS

TEST PITS → BORE HOLES → INFILTRATION RATE → SOIL CHEMISTRY

REMARKS	TEST PITS	BORE HOLES	INFILTRATION RATE	SOIL CHEMISTRY
	USUALLY WITH A BACKHOE, INCLUDES INSPECTION OF EXISTING SCS REPORTS, ROAD CUTS, ETC. (3.2.1)	DRILLED OR AUGERED, INCLUDES INSPECTION OF DRILLER'S LOGS FOR LOCAL WELLS, WATER TABLE LEVELS (3.2.2)	MATCH THE EXPECTED METHOD OF APPLICATION, IF POSSIBLE (3.4)	INCLUDES REVIEW OF SCS SURVEY (3.7)
INFORMATION TO OBTAIN	DEPTH OF PROFILE, TEXTURE, STRUCTURE, SOIL LAYERS RESTRICTING PERCOLATION	DEPTH TO GROUND WATER, DEPTH TO IMPERMEABLE LAYER(S)	EXPECTED MINIMUM INFILTRATION RATE	SPECIFIC DATA RELATING TO CROP AND SOIL MANAGEMENT, PHOSPHORUS AND HEAVY METAL RETENTION
ESTIMATES NOW POSSIBLE	NEED FOR VERTICAL CONDUCTIVITY TESTING	GROUND WATER FLOW DIRECTION	HYDRAULIC CAPACITY BASED ON SOIL PERMEABILITY (SUBJECT TO DRAINAGE RESTRICTIONS)	CROP LIMITATIONS. SOIL AMENDMENTS. POSSIBLE PRE-APPLICATION REQUIREMENTS.
ADDITIONAL FIELD TESTS	VERTICAL CONDUCTIVITY (OPTIONAL)	HORIZONTAL CONDUCTIVITY	--	--
ADDITIONAL ESTIMATES	REFINEMENT OF LOADING RATES	MOUNDING ANALYSIS, DISPERSION, NEED FOR DRAINAGE	--	QUALITY OF PERCOLATE
NUMBER OF TESTS	DEPENDS ON SIZE, SOIL UNIFORMITY, NEEDED SOIL TESTS, TYPE OF SYSTEM. TYPICAL MINIMUM OF 3 TO 5 PER SITE.	DEPENDS ON SYSTEM TYPE (MORE FOR RI THAN SR), SOIL UNIFORMITY, SITE SIZE. TYPICAL MINIMUM OF 3 PER SITE.	DEPENDS ON SIZE OF SITE, UNIFORMITY OF SOIL. TYPICAL MINIMUM OF 2 PER SITE.	DEPENDS ON UNIFORMITY OF SOIL TYPES, TYPE OF TEST, SIZE OF SITE

FIGURE 3-1
FLOW CHART OF FIELD INVESTIGATIONS

would signify the need for more detailed subsurface investigations than might normally be required. If a stream were located near the site, there would need to be additional study of the surface and near-surface hydrology; wells would create a concern about details of the ground water flow, and so on. These points may seem obvious. However, there are examples of systems that have failed because of just such obvious conditions: limitations that were not recognized until after design and construction were complete.

TABLE 3-1
SUMMARY OF FIELD TESTS FOR
LAND TREATMENT PROCESSES

Properties	Processes		
	Slow rate (SR)	Rapid infiltration (RI)	Overland flow (OF)
Wastewater constituents	Nitrogen, phosphorus, SAR ^a , EC ^a , boron	BOD, SS, nitrogen, phosphorus	BOD, SS, nitrogen, phosphorus
Soil physical properties	Depth of profile	Depth of profile	Depth of profile
	Texture and structure	Texture and structure	Texture and structure
Soil hydraulic properties	Infiltration rate	Infiltration rate	Infiltration rate (optional)
	Subsurface permeability	Subsurface permeability	--
Soil chemical properties	pH, CEC, exchangeable cations (% of CEC), EC ^a , metals ^b , phosphorus adsorption (optional)	pH, CEC, phosphorus adsorption	pH, CEC, exchangeable cations (% of CEC)

- a. May be more significant for arid and semiarid areas.
- b. Background levels of metals such as cadmium, copper, or zinc in the soil should be determined if food chain crops are planned.

3.2.1 Shallow Profile Evaluation

Following the initial field reconnaissance, some subsurface exploration will be needed. In the preliminary stages, this consists of digging pits, usually with a backhoe, at several carefully selected locations. Besides exposing the soil profile for inspection and sampling, the purpose is to identify subsurface features that could develop into site limitations, or that point to potential adverse features. Conditions such as fractured, near-surface rock, hardpan layers, evidence of mottling in the profile, lenses of open-work gravel and other anomalies should be carefully noted. For OF site evaluations, the depth of soil profile evaluation can be the top 1 m (3 ft) or so. The evaluation should extend to 1.5 m (5 ft) for SR and 3 m (10 ft) or more for RI systems.

3.2.2 Profile Evaluation to Greater Depths

In some site evaluations, the 2.5 to 3.7 m (about 8 to 12 ft) deep pits that can be excavated by a backhoe will not yield sufficient information on the profile to allow all the desired analyses to be made. For example, it may be necessary to locate both the ground water table and the depth to the closest impermeable layer. These depths together with horizontal conductivity values and certain other data are required to make mounding analyses, design drainage facilities, and for contaminant mass balance calculations.

Auger holes or bore holes are frequently used to explore soil deposits below the limits of pit excavation. Augers are useful to relatively shallow depths compared to other boring techniques. Depth limitation for augering varies with soil type and conditions, as well as hole diameter. In unconsolidated materials above water tables, 12.7 cm (5 in.) diameter holes have been augered beyond 35 m (115 ft). Cuttings that are continuously brought to the surface during augering are not suitable for logging the soil materials. Withdrawal of the auger flights for removal of the cuttings near the tip represents an improvement as a logging technique. The best method is to withdraw the flights and obtain a sample with a Shelby tube or split-spoon sampler.

Boring methods, which can be used to probe deeper than augering, include churn drilling, jetting, and rotary drilling. When using any of these methods it is preferable to clean out the hole and secure a sample from the bottom of the hole with a Shelby tube or split-spoon sampler.

3.3 Hydraulic Properties

The planning and design work relative to land treatment systems cannot be accomplished without estimates of several hydraulic properties of the site. The capacity of the soil to accept and transmit water is crucial to the design of RI systems and may be limiting in the design of some SR systems as well. In addition, tracking the movement and impacts of the wastewater and its constituents after application will always be an important part of design.

For purposes of this manual, hydraulic properties of soil are considered to be those properties whose measurement involves the flow or retention of water within the soil profile.

3.3.1 Saturated Hydraulic Conductivity

A material is considered permeable if it contains interconnected pores, cracks, or other passageways through which water or gas can flow. Hydraulic conductivity (synonymous with the term permeability in this manual) is a measure of the ease with which liquids and gases pass through soil. The term is more easily understood if a few basic concepts of water flow in soils are introduced first.

In general, water moves through soils or porous media in accordance with Darcy's equation:

$$q = \frac{Q}{A} = K \frac{dH}{dl} \quad (3-1)$$

where q = flux of water, the flow, Q per unit cross sectional area, A , cm/h (in./h)

K = hydraulic conductivity (permeability), cm/h (in./h)

dH/dl = hydraulic gradient, m/m (ft/ft)

The total head (H) can be assumed to be the sum of the soil-water pressure head (h), and the head due to gravity (Z), or $H = h + Z$. The hydraulic gradient is the change in total head (dH) over the path length (dl).

The hydraulic conductivity is defined as the proportionality constant, K . The conductivity (K) is not a true constant but a rapidly changing function of water content. Even under conditions of constant water content, such as saturation, K may vary over time due to increased swelling of clay particles, change in pore size distribution due to classification of particles, and change in the chemical nature of soil-water. However, for most purposes, saturated conductivity (K) can be considered constant for a given soil. The K value for flow in the vertical direction will not necessarily be equal to K in the horizontal direction. This condition is known as anisotropic. It is especially apparent in layered soils and those with large structural units.

The conductivity of soils at saturation is an important parameter because it is used in Darcy's equation to estimate ground water flow patterns (see Section 3.6.2) and is useful in estimating soil infiltration rates. Conductivity is frequently estimated from other physical properties but much experience is required and results are not sufficiently

accurate for design purposes [1-5]. For example, hydraulic conductivity is largely controlled by soil texture: coarser materials having higher conductivities. However, in some cases the soil structure may be equally important: well structured fine soils having higher conductivities than coarser unstructured soils.

In addition, hydraulic conductivity for a specific soil may be affected by variables other than those relating to grain size, structure, and pore distribution. Temperature, ionic composition of the water, and the presence of entrapped air can alter conductivity values [1].

3.3.2 Infiltration Capacity

The infiltration rate of a soil is defined as the rate at which water enters the soil from the surface. When the soil profile is saturated with negligible ponding above the surface, the infiltration rate is equal to the effective saturated conductivity of the soil profile.

When the soil profile is relatively dry, the infiltration rate is higher because water is entering large pores and cracks. With time, these large pores fill and clay particles swell reducing the infiltration rate rather rapidly until a near steady-state value is approached. This change in infiltration rate with time is shown in Figure 3-2 for several different soils. The effect of both texture and structure on infiltration rate is illustrated by the curves in Figure 3-2. The Aiken clay loam has good structural stability and actually has a higher final infiltration rate than the sandy loam soil. The Houston black clay, however, has very poor structure and infiltration drops to near zero.

For a given soil, initial infiltration rates may vary considerably, depending on the initial soil moisture level. Dry soil has a higher initial rate than wet soil because there is more empty pore space for water to enter. The short term decrease in infiltration rate is primarily due to the change in soil structure and the filling of large pores as clay particles absorb water and swell. Thus, adequate time must be allowed when running field tests to achieve a steady intake rate.

Infiltration rates are affected by the ionic composition of the soil-water, the type of vegetation, and tillage of the soil surface. Factors that have a tendency to reduce infiltration rates include clogging by suspended solids in wastewater, classification of fine soil particles, clogging due to biological growths, gases produced by soil microbes, swelling of soil colloids, and air entrapped during a

wetting event [6, 7]. These influences are all likely to be experienced when a site is developed into a land treatment system. The net result is to restrict the hydraulic loadings of land treatment systems to values substantially less than those predicted from the steady state intake rates (see Figure 3-2), requiring reliance on field-developed correlations between clean water infiltration rates and satisfactory operating rates for full-scale systems. It should be recognized that good soil management practices can maintain or even increase operating rates, whereas poor practices can lead to substantial decreases.

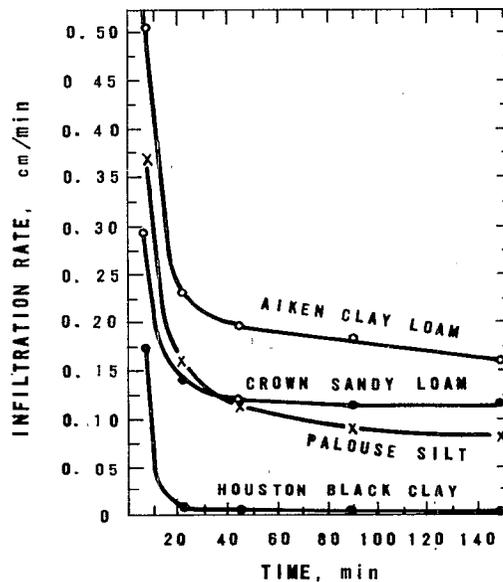

FIGURE 3-2
INFILTRATION RATE AS A FUNCTION
OF TIME FOR SEVERAL SOILS [3]

Although the measured infiltration rate on the particular site may decrease in time due to surface clogging phenomena, the subsurface vertical permeability at saturation will generally remain constant. That is, clogging in depth does not generally occur. Thus, the short-term measurement of infiltration serves reasonably well as an estimate of the long-term saturated vertical permeability if infiltration is measured over a large area. Once the infiltration surface begins to clog, however, the flow beneath the clogged layers tends to be unsaturated and at unit hydraulic gradient.

The short-term change in infiltration rate as a function of time is of interest in the design and operation of SR systems. A knowledge of how cumulative water intake varies with time is necessary to determine the time of application necessary to infiltrate the design hydraulic load. The design application rate of sprinkler systems should be selected on the basis of the infiltration rate expected at the end of the application period.

3.3.3 Specific Yield

The term specific yield is most often used in connection with unconfined aquifers and has also been called the storage coefficient and drainable voids. It is usually understood to be the volume of water released from a unit volume of unsaturated aquifer material drained by a falling water table. Although the term fillable porosity has occasionally been used as a synonym for the above three terms, it is actually a somewhat smaller quantity because of the effect of entrapped air. The primary use of specific yield values is in computing aquifer properties, for example, to perform ground water mound height analyses. For relatively coarse-grained soils and deep water tables, it is usually satisfactory to consider the specific yield a constant value. As computations are not extremely sensitive to small changes in the value of specific yield, it is usually satisfactory to estimate it from knowledge of other soil properties, either physical as in Figure 3-3 [8], or hydraulic as in Figure 3-4 [9]. To clarify Figure 3-3, specific retention is equal to the porosity minus the specific yield.

A note of caution, however. For fine-textured soils, especially as the water table moves higher in the profile, the specific yield may not have a constant value because of capillarity. Discussion of this complication may be found in references [10, 11]. The effect of decreasing specific yield with increasing water table height can lead to serious difficulties with mound height analysis (Section 5.7.2).

3.3.4 Unsaturated Hydraulic Conductivity

The conductivity of soil varies dramatically as water content is reduced below saturation. As an air phase is now present, the flow channel is changed radically and now consists of an irregular solid boundary and the air-water interface. The flow path becomes more and more tortuous with decreasing water content as the larger pores empty and

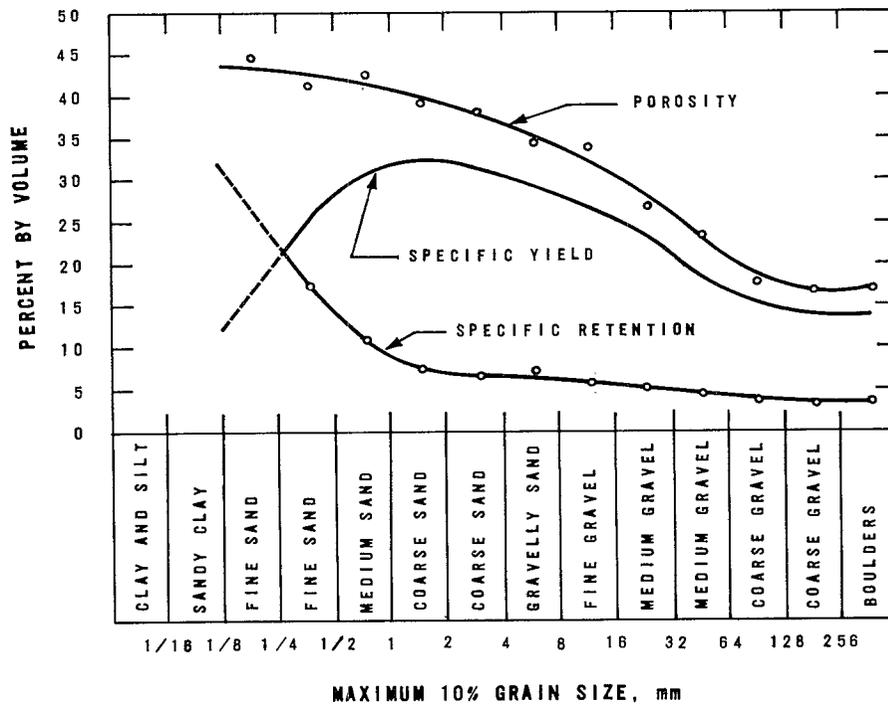

FIGURE 3-3
 POROSITY, SPECIFIC RETENTION, AND
 SPECIFIC YIELD VARIATIONS WITH GRAIN SIZE
 SOUTH COASTAL BASIN, CALIFORNIA [8]

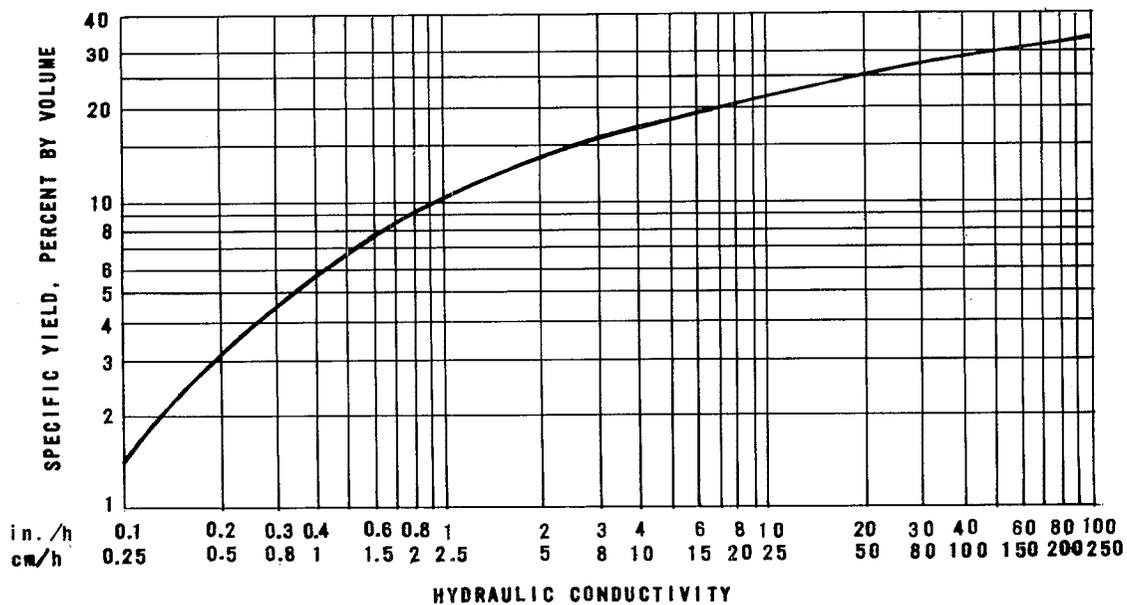

FIGURE 3-4
 GENERAL RELATIONSHIP BETWEEN SPECIFIC YIELD
 AND HYDRAULIC CONDUCTIVITY [9]

flow becomes confined to the smaller pores. Compounding the effect of decreasing cross-sectional area for flow is the effect of added friction as the flow takes place closer and closer to solid particle surfaces. The conductivity of sandy soils, although much higher at saturation than loamy soils, decreases more rapidly as the soil becomes less saturated. In most cases, the conductivities of sandy soils eventually become lower than finer soils. This relationship explains why a wetting front moves more slowly in sandy soils than medium or fine soils after irrigation has stopped and why there is little horizontal spreading of moisture in sandy soils after irrigation.

Estimating water movement under unsaturated conditions using Darcy's equation and unsaturated K values is complex. A discussion of such calculations is outside the scope of this manual. The user is referred to references [1, 10, 12, 13] for further details and solution of special cases.

3.3.5 Profile Drainage

For SR systems that are operated at application rates considerably in excess of crop irrigation requirements, it is often desirable to know how rapidly the soil profile will drain and/or dry after application has stopped. This knowledge, together with knowledge of the limiting infiltration rate of the soil and the ground water movement and buildup, allows the designer to make a reasonable estimate of the maximum volume of water that can be applied to a site and still produce adequate crops. A typical moisture profile and its change with time following an irrigation is illustrated in Figure 3-5 for an initially saturated profile. Moisture profile changes may be determined in the field with tensiometers [4].

3.4 Infiltration Rate Measurements

The value that is required in land treatment design is the long-term acceptance rate of the entire soil surface on the proposed site for the actual wastewater effluent to be applied. The value that can be measured is only a short-term equilibrium acceptance rate for a number of particular areas within the overall site.

There are many potential techniques for measuring infiltration including flooding basin, cylinder infiltrometers, sprinkler infiltrometers and air-entry permeameters. A comparison of these four techniques is presented in Table 3-2. In general, the test area and the volume of water used should be as large as practical. The two main categories of measurement techniques are those involving

flooding (ponding over the soil surface) and rainfall simulators (sprinkling infiltrometer). The flooding type of infiltrometer supplies water to the soil without impact, whereas the sprinkler infiltrometer provides an impact similar to that of natural rain. Flooding infiltrometers are easier to operate than sprinkling infiltrometers, but they almost always give higher equilibrium infiltration rates. In some cases, the difference is very significant, as shown in Table 3-3. Nevertheless, the flooding measurement techniques are generally preferred because of their simplicity. Relationships between infiltration rates as obtained by various flooding techniques and the loading rates of RI systems are discussed in Section 5.4.1. The air entry permeameter is described in Section 3.5.2.

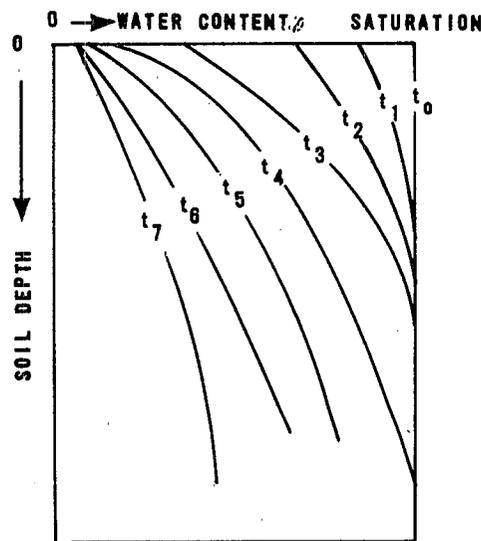

FIGURE 3-5
TYPICAL PATTERN OF THE
CHANGING MOISTURE PROFILE DURING DRYING AND DRAINAGE

If a sprinkler or flood application is planned, the test should be conducted in surficial materials. If RI is planned, pits must be excavated to expose lower horizons that will constitute the bottoms of the basins. If a more restrictive layer is present below the intended plane of infiltration and this layer is close enough to the intended plane to interfere, the test should be conducted at this layer to ensure a conservative estimate.

TABLE 3-2
COMPARISON OF INFILTRATION
MEASUREMENT TECHNIQUES

Measurement technique	Water use per test, L	Time per test, h	Equipment needed	Comments
Flooding basin	2,000-10,000	4-12	Backhoe or blade	Tensiometers may be used
Cylinder infiltrometer	400-700	1-6	Cylinder or earthen berm	Should use large diameter cylinders (1 m diameter)
Sprinkler infiltrometer	1,000-1,200	1.5-3	Pump, pressure tank, sprinkler, cans	For sprinkler applications, soil should be at field capacity before test
Air entry permeameter (AEP)	10	0.5-1	AEP apparatus, standpipe with reservoir	Measures vertical hydraulic conductivity. If used to measure rates of several different soil layers, rate is harmonic mean of conductivities from all soil layers.

Note: See Appendix G for metric conversions.

TABLE 3-3
SAMPLE COMPARISON OF INFILTRATION MEASUREMENT
USING FLOODING AND SPRINKLING TECHNIQUES [14]

Measurement technique	Equilibrium infiltration rate, cm/h	
	Overgrazed pasture	Pasture, grazed but having good cover
Double-cylinder infiltrometer (flooding)	2.82	5.97
Type F rainfall simulator (sprinkling)	2.90	2.87

Infiltration test results are typically plotted as shown in Figures 3-2 and B-3. The derivation of design values from these test results is presented in Appendix B.

Before discussing the infiltration measurement techniques, it should be pointed out that the U.S. Public Health Service (USPHS) percolation test used for establishing the size of septic tank drain fields [15] is definitely not recommended as a method for estimating infiltration.

3.4.1 Flooding Basin Techniques

Pilot-scale infiltration basins represent an excellent technique for determining vertical infiltration rates. The larger the test area is, the less the relative error due to lateral moisture movement will be and the better the estimate. Where such basins have been used, the plots have generally ranged from about 0.9 m² (10 ft²) to 0.1 ha (0.25 acre). In some cases, pilot basins of large scale (2 to 3.2 ha or 5 to 8 acres) have been used to determine infiltration rates and demonstrate feasibility with the thought of incorporating the test basins into a subsequent full-scale system [16]. Figure 3-6 is a photograph of a pilot basin.

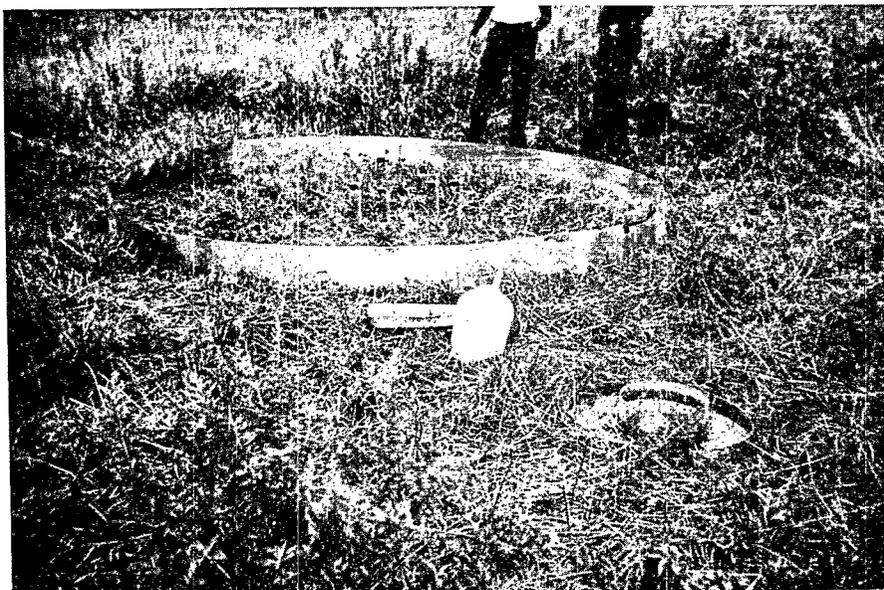

FIGURE 3-6
FLOODING BASIN USED FOR MEASURING INFILTRATION

The Corps of Engineers has used flooding basin tests to determine infiltration rates on three existing land treatment sites [17]. Basins of 6.1 m (20 ft) and 3 m (10 ft) diameter were used and it was concluded that the 3 m (10 ft) diameter basin was large enough to provide reliable infiltration data. About 4 man-hours were required for completing an installation and less than 1,000 L (265 gal) of water would probably be adequate to complete a test. As this testing procedure will undoubtedly become more widely adopted, Figures 3-7 and 3-8 are included to show the details of installation [18].

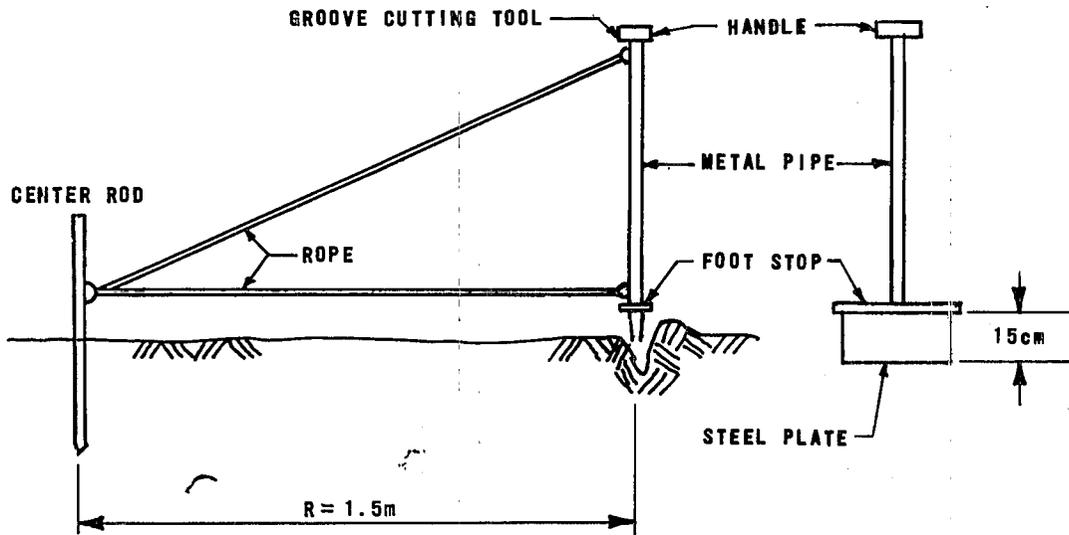

FIGURE 3-7
GROOVE PREPARATION FOR FLASHING (BERM) [18]

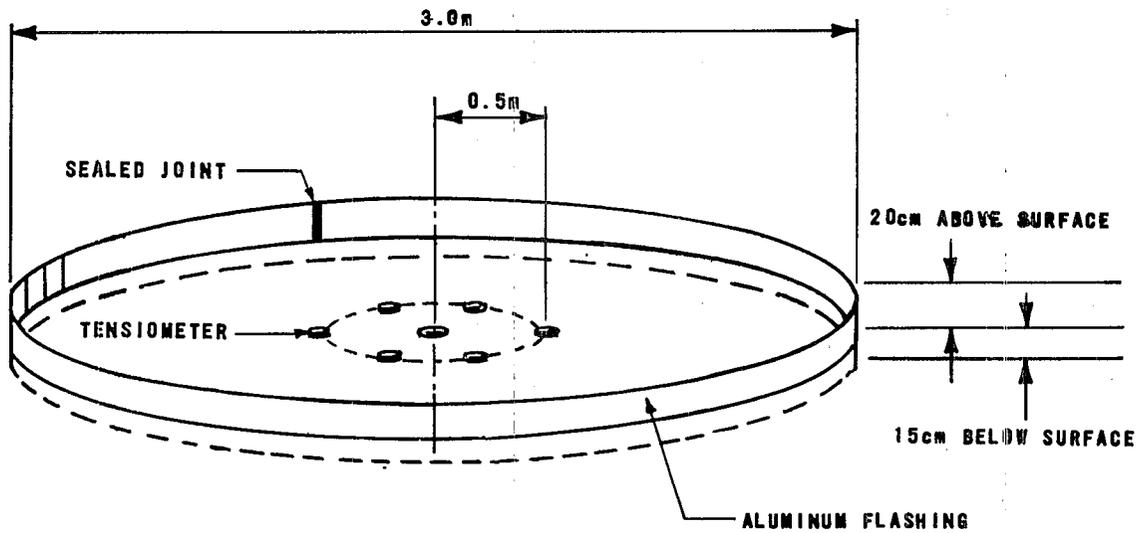

FIGURE 3-8
SCHEMATIC OF FINISHED INSTALLATION [18]

An important assumption in any flooding type infiltration test is a saturated (or nearly so) condition in the upper soil profile. Thus, an essential part of this method is the installation of a number of tensiometers within the test area at various depths to verify saturation by their approach to a zero value of the matric potential, before obtaining any head drop (water level) measurements. In the Corps of Engineers studies, six tensiometers were installed in a 1 m (3.3 ft) diameter circle concentric with the center of the 3 m (10 ft) diameter test basin as shown in Figure 3-8. Table 3-4 gives their suggested depths of placement in a soil of well-developed horizons; however, any reasonable spacing above strata of lower conductivity, if such exist, should be adequate. In soils lacking well-developed horizons, a uniform spacing down to about 60 cm (24 in.) should suffice. A seventh tensiometer installed at a depth of about 150 cm (60 in.) is also suggested, but is not critical.

TABLE 3-4
SUGGESTED VERTICAL PLACEMENT OF
TENSIO METER S IN BASIN INFILTR O METER TESTS [18]

No.	Soil horizon	Placement
1	A	Midpoint of A
2	B	1/5 distance between A/B and B/C interfaces
3	B	2/5 distance between A/B and B/C interfaces
4	B	3/5 distance between A/B and B/C interfaces
5	B	4/5 distance between A/B and B/C interfaces
6	C	15 cm below B/C interface

Following installation and calibration of the tensiometers, a few preliminary flooding events are executed to achieve saturation. Evidence of saturation is the reduction of tensiometer readings to near zero through the upper soil profile. Then a final flooding event is monitored to derive a cumulative intake versus time curve. A best fit to the data plotted on log-log paper allows calculation of the infiltration parameters, as shown in Figure 3-9. Subsequent observation of tensiometers can then provide data on profile drainage.

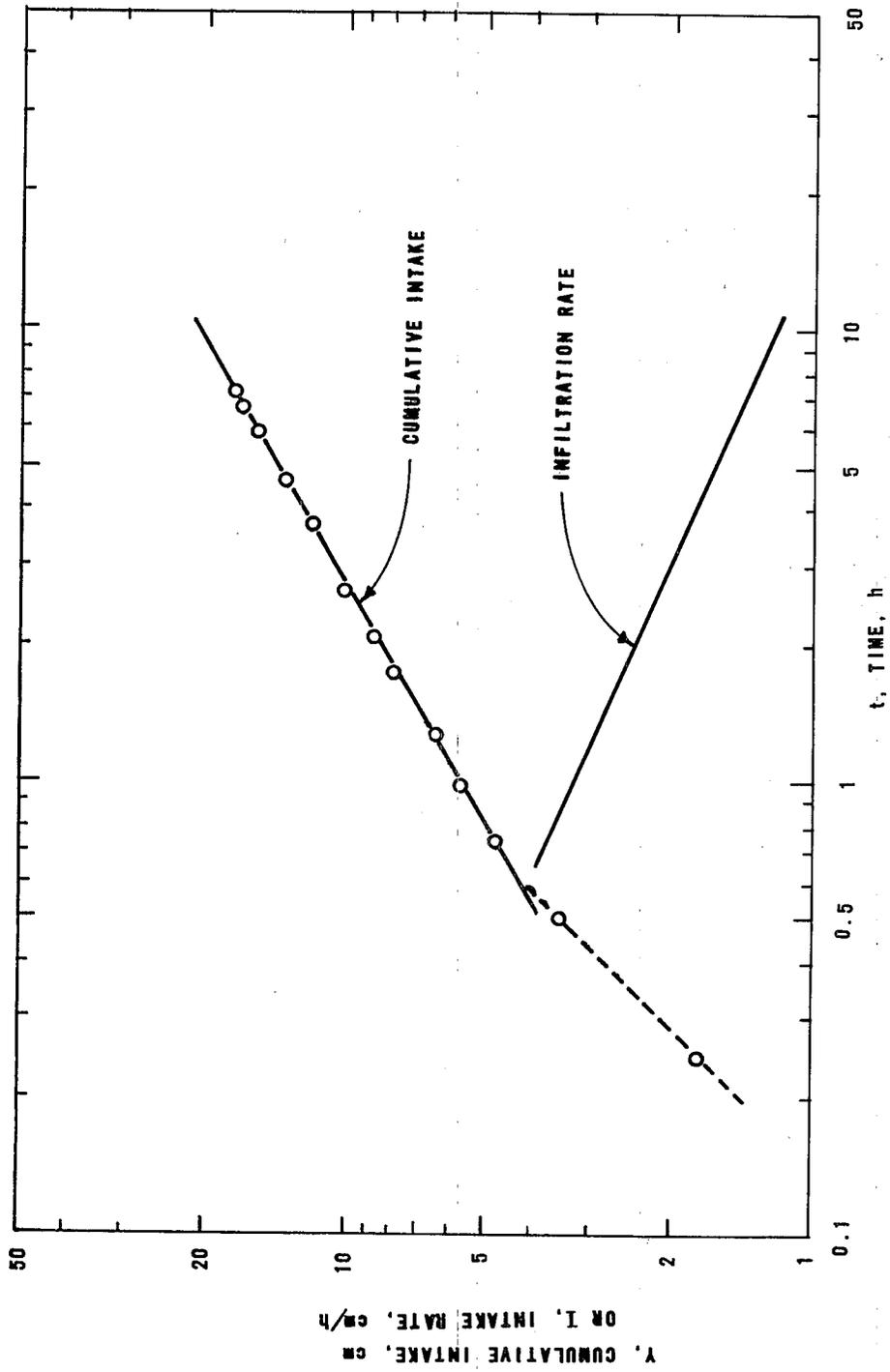

FIGURE 3-9
INFILTRATION RATE AND CUMULATIVE INTAKE DATA PLOT

3.4.2 Cylinder Infiltrometers

The equipment and basic methodology for this popular measurement technique are described in references [9, 19, 20]. The equipment setup for a test is shown in Figure 3-10.

To run a test, a metal cylinder is carefully driven or pushed into the soil to a depth of about 10 to 15 cm (4 to 6 in.). Measurement cylinders of from 15 to 35 cm (6 to 14 in.) diameter have generally been used in practice, with lengths of about 25 to 30.5 cm (10 to 12 in.). Divergent flow, partially obstructed by the portion of the cylinder beneath the soil surface, is further minimized by means of a "buffer zone" surrounding the central ring. The buffer zone is commonly provided by another cylinder 40 to 70 cm (16 to 30 in.) diameter, driven to a depth of 5 to 10 cm (2 to 4 in.) and kept partially full of water during the time of infiltration. This particular mode of making measurements has come to be known as the double-cylinder or double-ring infiltrometer method. Care must be taken to maintain the water levels in the inner and outer cylinders at the same level during the measurements. Alternately, buffer zones are provided by diking the area around the intake cylinder with low (7.5 to 10 cm or 3 to 4 in.) earthen dikes.

If the cylinder is installed properly and the test carefully performed, the technique should produce data that at least approximate the vertical component of flow. In most soils, as the wetting front advances downward through the profile, the infiltration rate will decrease with time and approach a steady-state value asymptotically. This may require as little as 20 to 30 minutes in some soils and many hours in others. Certainly, one could not terminate a test until the steady-state condition was attained or the results would be totally meaningless (see Figure 3-2).

Anyone contemplating the use of this measurement technique because of its apparent simplicity should also be aware of its limitations. Discussions dealing specifically with the problem of separating the desired vertical component from the total moisture flux, which may include a large lateral component, can be found in references [21, 22].

A more promising direction is suggested in reference [19] in which the main conclusion is applicable: to minimize errors in the use of the cylinder infiltrometer technique; use only large-diameter cylinders and careful installation techniques. The specific recommendation as to cylinder diameter is a minimum of 1 m (3.3 ft).

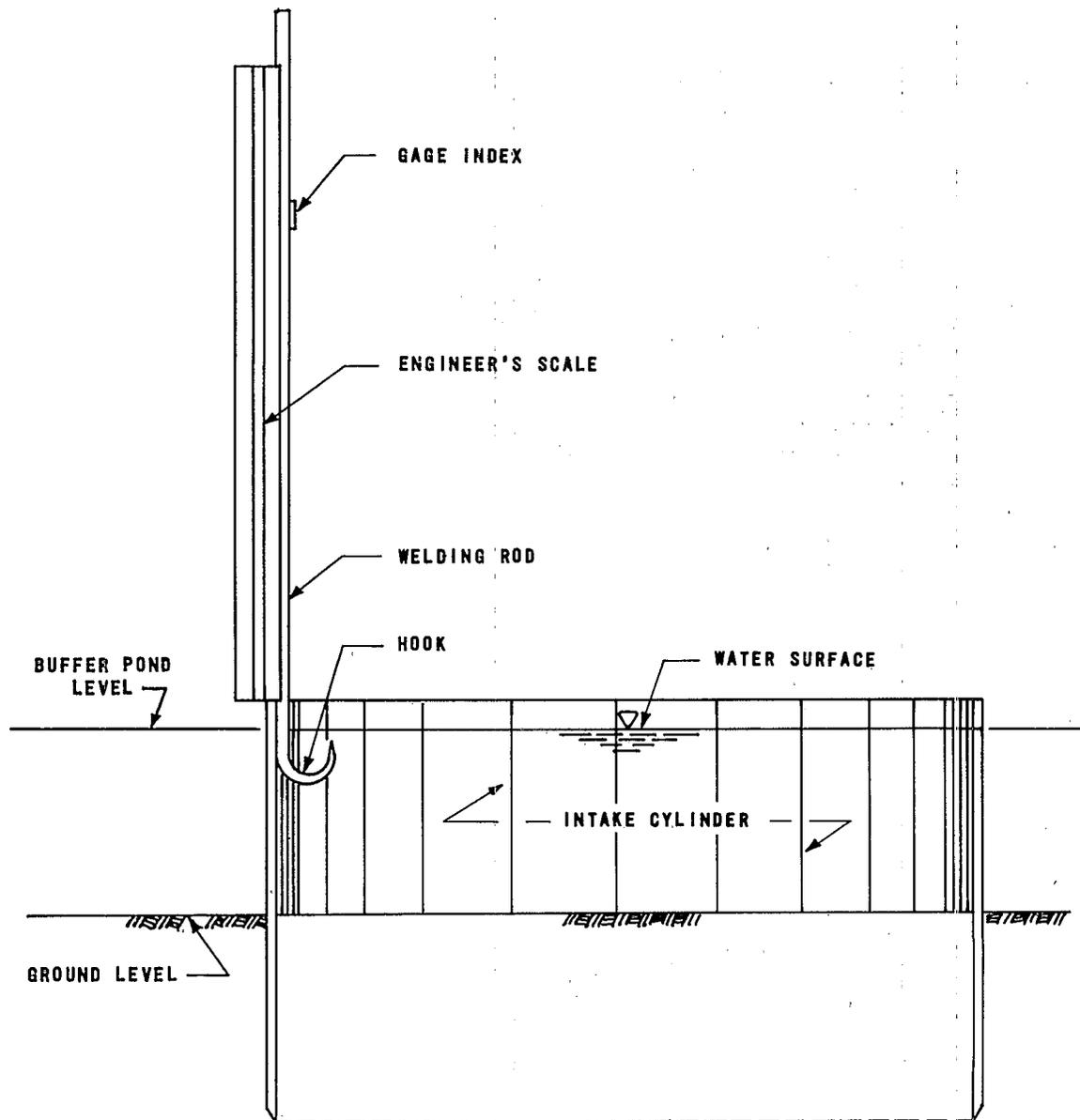

FIGURE 3-10
CYLINDER INFILTROMETER IN USE

Installation should disturb the soil as little as possible. This generally requires thin-walled cylinders with a beveled edge and very careful driving techniques. In soft soils, cylinders may be pushed or jacked in. In harder soils, they must be driven in. The cylinders must be kept straight during this process, especially avoiding a "rocking" or tilting motion to advance them downward. In cohesionless coarse sands and gravels, a poor bond between the soil and the metal cylinder often results, allowing seepage around the edge of the cylinder. Such conditions may call for special methods to be devised. One such method is to construct the test area by forming low dikes and covering the inside walls with plastic sheet to prevent lateral seepage [19]. This begins to approach the basin flooding method described in Section 3.4.1.

Measurements of infiltration capacity of soils often show wide variations within a relatively small area. Hundred-fold differences are common on some sites. Assessing hydraulic capacity for a project site is especially difficult because test plots may have adequate capacity when tested as isolated portions, but may prove to have inadequate capacity after water is applied to the total area for prolonged periods. Problem areas can be anticipated more readily by field study following spring thaws or extended periods of heavy rainfall and recharge [23]. Runoff, ponding, and near saturation conditions may be observed for brief periods at sites where drainage problems are likely to occur after extensive application begins.

Although far too few extensive tests have been made to gather meaningful statistical data on the cylinder infiltrometer technique, one very comprehensive study is available from which tentative conclusions can be drawn.

Test results from three plots (357 individual tests) located on the same homogeneous field were compared. In addition, test results from single-cylinder infiltrometers with no buffer zone were compared with those from double-cylinder infiltrometers. The inside cylinders had a 15 cm (6 in.) diameter; the outside cylinders, where used, had a 30 cm (12 in.) diameter. For this particular soil, the presence of a buffer zone did not have a significant effect on the measured rates. These data, although very carefully taken, overestimate the field average by about 40%, indicating that small diameter cylinders will consistently overestimate the true vertical infiltration rate [14].

3.4.3 Sprinkler Infiltrometers

Sprinkler infiltrometers are used primarily to determine the limiting application rate for systems using sprinklers. To measure the soil intake rate for sprinkler application, the method presented in reference [24] can be used. The equipment needed includes a trailer-mounted water recirculating unit, a sprinkler head operating inside a circular shield with a small side opening, and approximately 50 rain gages.

A schematic diagram of a typical sprinkler infiltrometer is presented in Figure 3-11. A 1,814 kg (2 ton) capacity trailer houses a 1,135 L (300 gal) water supply tank and 2 self-priming centrifugal pumps. The sprinkler pump should have sufficient capacity to deliver at least 6.3 L/s (100 gal/min) at 34.5 N/cm² (50 lb/in.²) to the sprinkler nozzle, and the return flow pump should be capable of recycling all excess water from the shield to the supply tank. The circular sprinkler shield is designed to permit a revolving head sprinkler to operate normally inside the shield. The opening in the side of the shield restricts the wetted area to about one-eighth of a circle. Prior to testing, the soil in the wetted area is brought up to field capacity. Rain gages are then set out in rows of three spaced at 1.5 m (5 ft) intervals outward from the sprinkler in the center of the area to be wetted. The sprinkler is operated for about 1 hour. The intake of water in the soil at various places between gages is observed to determine whether the application rate is less than, greater than, or equal to the infiltration rate.

The area selected for measurement of the application rate is where the applied water just disappears from the soil surface as the sprinkler jet returns to the spot. At the end of the test (after 1 hour), the amount of water caught in the gages is measured and the intake rate is calculated. The calculated rate of infiltration is equal to the limiting application rate that the soil system can accept without runoff.

Disadvantages of the technique are the time and expense involved in determining intake rates using a sprinkler infiltrometer. There is, in fact, little reason to try to measure maximum intake rates on soils that are going to be loaded far below these maximum rates, as is the case for most SR system designs. However, where economics dictate the use of application rates far in excess of the consumptive use (CU) of the proposed crop on soils of known or suspected hydraulic limitation, a test such as described

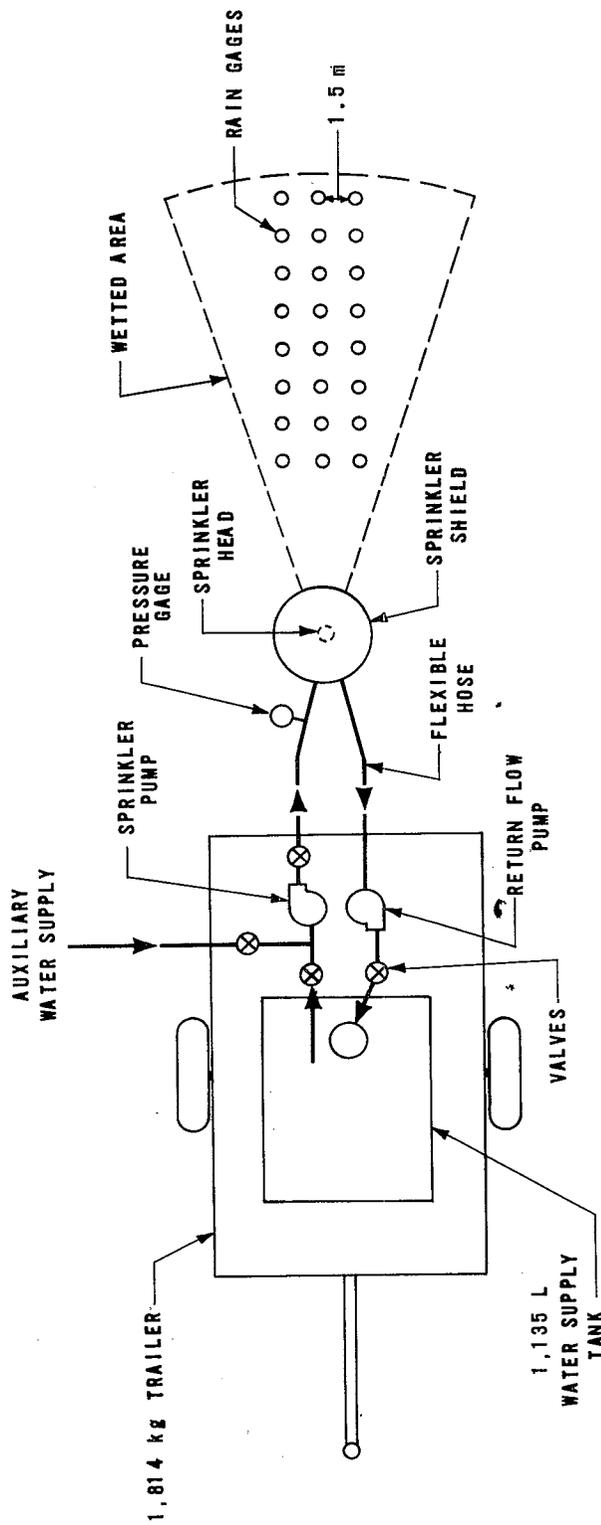

FIGURE 3-11
LAYOUT OF SPRINKLER INFILTROMETER [24]

above should be given careful consideration. Local SCS field personnel or irrigation specialists should be consulted for opinions on the advisability of making such tests.

3.5 Measurement of Vertical Hydraulic Conductivity

The rate at which water percolates through the soil profile during application depends on the "average" saturated conductivity (K_s) of the profile. If the soil is uniform, K is assumed to be constant with depth. Any differences in measured values of K are then due to normal variations in the measurement technique. Thus, average K may be computed as the arithmetic mean of n samples:

$$K_{am} = \frac{K_1 + K_2 + K_3 + \dots + K_n}{n} \quad (3-2)$$

where K_{am} = arithmetic mean vertical conductivity

Many soil profiles approximate a layered series of uniform soils with distinctly different K values, generally decreasing with depth. For such cases, it can be shown that average K is represented by the harmonic mean of the K values from each layer [25]:

$$K_{hm} = \frac{D}{\frac{d_1}{K_1} + \frac{d_2}{K_2} + \dots + \frac{d_n}{K_n}} \quad (3-3)$$

where D = soil profile depth

d_n = depth of n th layer

K_{hm} = harmonic mean conductivity

If a bias or preference for a certain K value is not indicated by statistical analysis of field test results, a random distribution of K for a certain layer or soil region must be assumed. In such cases, it has been shown that the geometric mean provides the best estimate of the true K [25, 26, 27]:

$$K_{gm} = (K_1 \cdot K_2 \cdot K_3 \cdot \dots \cdot K_n)^{1/n} \quad (3-4)$$

where K_{gm} = geometric mean conductivity

The relationships between vertical hydraulic conductivity and the loading rates for RI systems are discussed in Section 5.4.1.

There are many in situ methods available to measure vertical saturated conductivity. For convenience, these may be divided into methods in the presence of and in the absence of a water table. In addition, there are several laboratory techniques which are used to estimate saturated conductivity in soil samples taken from pits or bore holes. Either constant-head or falling-head permeameters can be used for these estimates. Detailed test procedures may be found in any good soil mechanics text. The main criticisms of the use of laboratory techniques are the disturbance of the sample during collection by pushing or driving a sampler into it and the small size of sample tested. These criticisms are entirely valid. Nonetheless, when estimates of conductivity are needed from deep lying strata that physically cannot be examined in situ, then sampling and laboratory measurement may be the only feasible technique.

The only important test used below a water table is the pipe cavity, or piezometer tube method [28], described in practical terms in reference [29]. This test is especially helpful when the soils below the water table are layered, with substantially different vertical conductivities in each strata. In such cases, a separate test should be run in each of the layers of interest in order to apply Equation 3-3. The most important application occurs when there is evidence of vertical gradients that could transport percolate downward to lower lying aquifers.

Methods available to measure vertical saturated conductivity in a soil region above, or in the absence of a water table, include the ring permeameter [9, 30], the gradient-intake [1, 31], the double-tube [1, 30] and the air-entry permeameter [1, 32, 33]. With the development of the newer techniques, the ring permeameter method, which requires an elaborate setup and uses a lot of water per test, is no longer in widespread use. The gradient-intake technique is primarily used as a site screening method, for ranking the relative conductivities of different soils. Conductivity values obtained by this method are considered conservative as they often prove to be lower than those produced by other methods.

In practice, the double-tube and air-entry permeameters have found favor and are used more frequently than the other techniques. Therefore, only these two methods will be discussed. Enough information will be given here to enable the user to understand the basic measurement concepts.

Procedural details are covered more completely in the references supplied.

3.5.1 Double-Tube Method

The test is run in a hole augered to the depth of the soil layer whose vertical conductivity is desired. Certainly that of the most restrictive layer is needed as a minimum. Additional layers in the profile should be investigated to ensure proper characterization. The value of K which is computed from double-tube includes a small horizontal component but primarily reflects vertical flow. The apparatus (commercially available*) is shown in Figure 3-12. To perform a test, it is first necessary to create a saturated zone of soil beneath the embedded tubes. This is accomplished by applying water through both tubes for several hours. Then two sets of measurements are required:

1. Water level versus time readings for the inner tube with the supply to this tube stopped while maintaining the supply to the outer tube.
2. Water level versus time readings for the inner tube with the supply to this tube and to the outer tube stopped. The level in this outer tube is held (closely) the same as that in the inner tube during this second set of readings by manipulating a valve (C in Figure 3-12).

The curves of water level decreases versus time are then plotted to the same scale and K is calculated. Details of the calculation and curves needed to obtain a dimensionless factor for the calculation are to be found in references [1, 30] and are supplied by the manufacturer of the equipment.

3.5.2 Air-Entry Permeameter

The air-entry permeameter was devised to investigate the significance of flows in the capillary zone [32]. Using the device as shown in Figure 3-13, the soil-water pressure at which air entered the saturated voids was approximated.

*Soiltest, Inc., Evanston, Illinois 60202. Mention of proprietary equipment does not constitute endorsement by the U.S. Government.

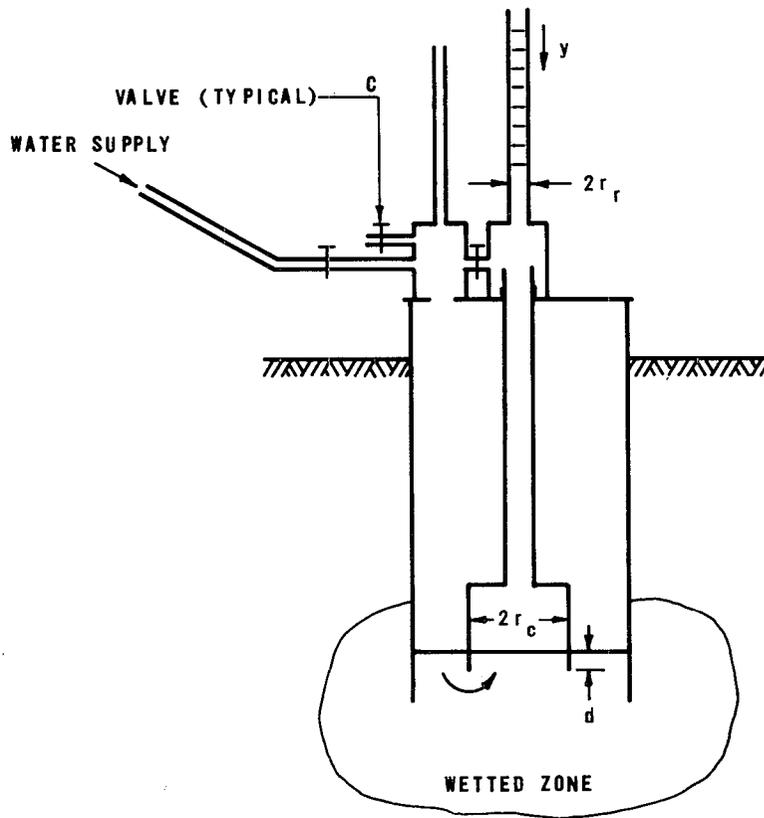

FIGURE 3-12
SCHEMATIC OF DOUBLE-TUBE APPARATUS [1]

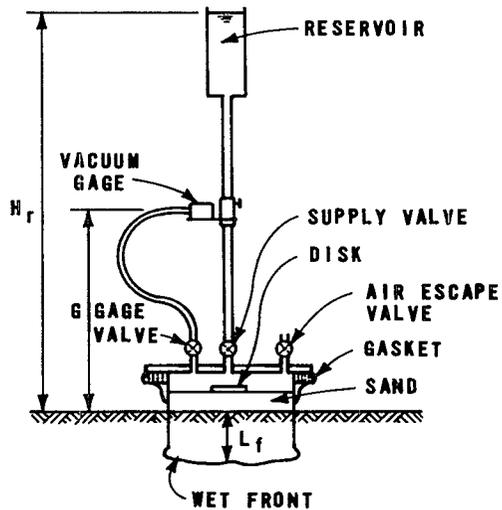

FIGURE 3-13
SCHEMATIC OF THE AIR-ENTRY PERMEAMETER [1,32]

Assuming a relationship between this value and the pressure just above the advancing front of a wetted zone, the conductivity of a mass of soil absorbing water to the point of saturation can be calculated. Because of the availability of research data to indicate that this conductivity value is closely equal to one-half the saturated hydraulic conductivity, a new method of determining vertical hydraulic conductivity at saturation became available.

Although the method may appear to have the limitation of requiring several assumptions, it compares favorably with other accepted methods and has some distinct advantages. The equipment is relatively simple; the test does not take much time; and, perhaps most important, not much water is required. A few liters of water will generally suffice for a single test.

In operation, water is added through the supply valve with the air valve open until the embedded cylinder becomes full (the function of the disk is to act as a splash plate). On filling the cylinder, the air valve is closed and water is allowed to infiltrate downward, the reservoir being kept full.

When the wet front, L_f , has reached the desired depth, dependent on soil texture and structure (see subsequent remarks), no more water is added to the reservoir. The drop in water level with time is measured in order to calculate an intake rate. Now the supply valve is closed and the pressure on the vacuum gage is noted periodically. At some point it will reach a maximum (minimum pressure) and then begin to decrease again. This minimum pressure corresponds closely to the air-entry pressure, P_a , of the wetted zone when corrected for gage height, G , and depth of wetted zone, L_f .

When the air-entry permeameter is employed at the soil surface, it is essentially an infiltrometer and as such could readily be listed with the method of Section 3.4.2. Several investigators [32, 33] have used the method to develop vertical conductivity profiles. It has been suggested that digging a trench with an inclined bottom, then moving the air-entry permeameter to selected points along the trench bottom is a good method of accomplishing this.

A criticism of the original technique [32] was based on the suggested methods of defining the depth of the wetted zone beneath the cylinder. These called for digging around the bottom of the cylinder after completion of the measurements to locate the wet front or using a metal rod to probe the soil, attempting to detect the depth at which penetration

resistance increases. However, the air-entry permeameter was modified by adding a fine tensiometer probe through the lid of the device. By setting the probe to correspond to the desired depth of wetted zone, L_f (about 15 cm or 6 in. in sand and 5 cm or 2 in. in massive clay), it was possible to detect the arrival of the wetted front during, rather than after operation of the permeameter. This modification also allows the method to be used in somewhat wetter soils than those previously required.

Referring to Figure 3-13, the vertical hydraulic conductivity of the "rewet" zone, i.e., the zone being saturated, is calculated from Equation 3-5.

$$K = \frac{Q}{A} \frac{L_f}{(H_r + L_f + H_1)} \quad (3-5)$$

- where:
- Q = volumetric intake rate through area, A , of the permeameter
 - H_1 = the matric potential of the soil just below the wetting zone, assumed to be $0.5 P_a$. It is less than atmospheric pressure and therefore a negative quantity in Equation 3-5
 - P_a = air-entry value, calculated as $P_{\min} + L_f + G$; also a negative pressure
 - P_{\min} = minimum pressure (maximum vacuum) read from the vacuum gage after stopping the water supply
 - G = height of the vacuum gage above the soil surface
 - L_f = depth of the wetted zone
 - H_r = height of the water level in the reservoir above the soil surface

Then, as stated previously, the vertical hydraulic conductivity at saturation is assumed to be two times the value of K as calculated from Equation 3-5.

3.6 Ground Water

In most land treatment systems, and especially for the higher rate systems, interaction with the ground water is important and must be considered carefully in the

preliminary analysis phase. Problems with mounding, drainage, offsite travel and ultimate fate of contaminants in the percolate will have to be addressed during both the analysis and design phases. Early recognition of potential problems and analysis of mitigating measures are necessary for successful operation of the system. This cannot be accomplished without competent field investigation. Some key questions to be answered are:

1. How deep beneath the surface is the (undisturbed) water table?
2. How does the natural water table depth fluctuate seasonally?
3. How will the ground water table respond to the proposed wastewater loadings?
4. In what direction and how fast will the mixture of percolate and ground water move from beneath the area of application? Is there any possibility of transport of contaminants to deeper potable aquifers?
5. What will be the quality of this mixture as it flows away from the site boundaries?
6. If any of the conditions measured or predicted above are found to be unacceptable, what steps can be taken to correct the situation?

3.6.1 Depth/Hydrostatic Head

A ground water table is defined as the contact zone between the free ground water and the capillary zone. It is the level assumed by the water in a hole extended a short distance below the capillary zone. Ground water conditions are regular when there is only one ground water surface and when the hydrostatic pressure increases linearly with depth. Under this condition, the piezometric pressure level is the same as the free ground water level regardless of the depth below the ground water table at which it is measured. Referring to Figure 3-14, the water level in the "piezometer" would stand at the same level as the "well" in this condition.

In contrast to a well, a piezometer is a small diameter open pipe driven into the soil such that (theoretically) there can be no leakage around the pipe. As the piezometer is not slotted or perforated, it can respond only to the hydrostatic head at the point where its lower open end is

located. The basic difference between water level measurement with a well and hydrostatic head measurement with a piezometer is shown in Figure 3-14.

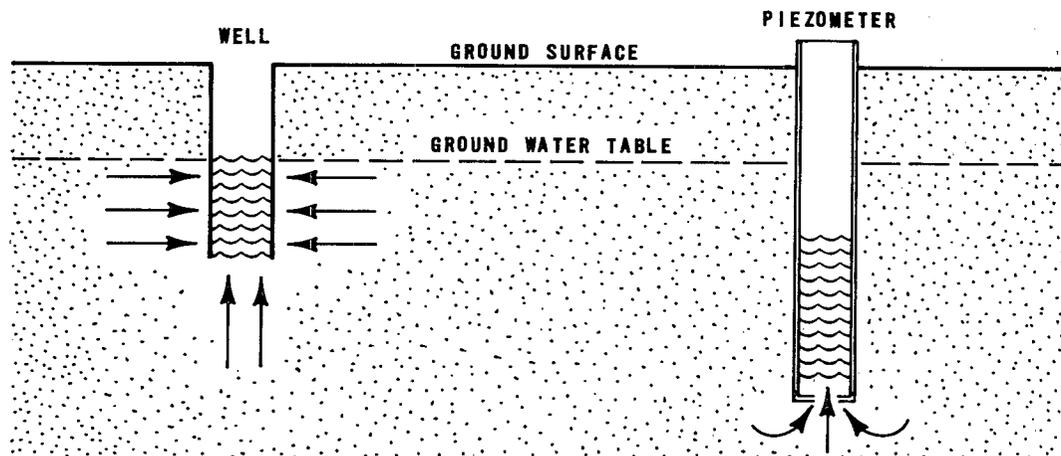
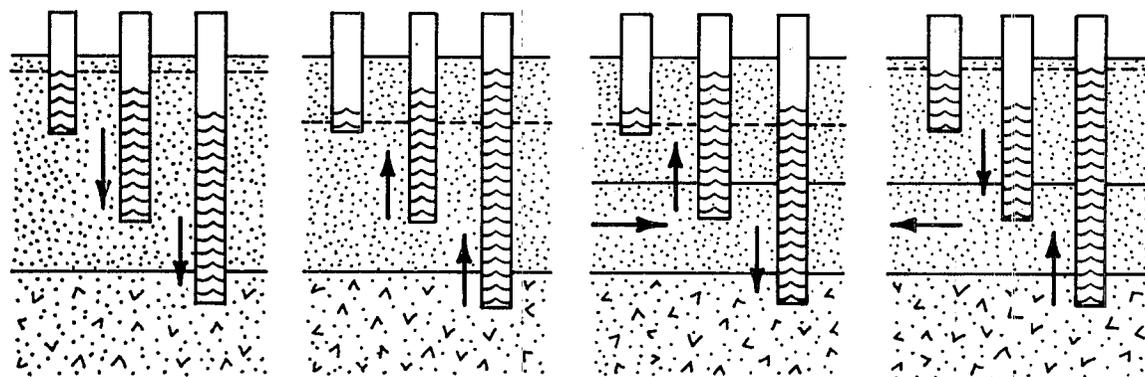

FIGURE 3-14
WELL AND PIEZOMETER INSTALLATIONS

Occasionally there may be one or more isolated bodies of water "perched" above the main water table because of lenses of impervious strata that inhibit or even prevent seepage past them to the main body of ground water below. Other "irregular" conditions are described by Figure 3-15.

Reliable determination of either ground water levels or pressures requires that the hydrostatic pressures in the bore hole and the surrounding soil be equalized. Attainment of stable levels may require considerable time in impermeable materials. This is called hydrostatic time-lag and may be from hours to days in materials of practical interest ($K > 10^7$ cm/s).

Two or more piezometers located together, but terminating at different depths, can indicate the presence, direction and magnitude (gradient) of components of vertical flow if such exists. Their use is indicated whenever there is concern about movement of contaminants downward to lower lying aquifers. Figure 3-15, taken from reference [34], shows several observable patterns with explanations. Descriptions of the proper methods of installation of both observation wells and piezometers may be found in references [9, 34].



THE PIEZOMETERS INDICATE THAT THE GROUND WATER IS GOING DOWN AND THAT THERE IS SOME NATURAL DRAINAGE.

THE PIEZOMETERS INDICATE A HYDROSTATIC PRESSURE OR THAT THERE IS WATER COMING UP FROM A DEEPER STRATA.

THE PIEZOMETERS INDICATE A HYDROSTATIC PRESSURE IN A STRATUM AND THAT WATER IS BEING FORCED BOTH UP AND DOWN FROM THE STRATUM

THE PIEZOMETERS INDICATE THAT GROUND WATER IS MOVING INTO A STRATUM AND GOING OUT OF THE AREA.

FIGURE 3-15
VERTICAL FLOWS INDICATED BY PIEZOMETERS [34]

3.6.2 Flow

Exact mathematical description of flows in the saturated zones beneath and adjacent to (usually downgradient) land treatment systems is a practical impossibility. However, for the majority of cases the possession of sufficient field data will allow an application of Darcy's equation (Equation 3-1). Answers can thus be obtained which are satisfactory for making design decisions. In particular, there are questions which recur for each proposed project, and which may be approached in the manner suggested.

1. What volume of native ground water flows beneath the proposed site for dilution of percolate? This is a direct application of Equation 3-1. The width of the site measured normal to the ground water flow lines times the aquifer thickness equals the cross-sectional area used to compute the total flow.
2. What is the mean travel time between points of entry of percolate into the ground water and potential points of discharge or withdrawal? Again, Equation 3-1 is used to compute the flux, q . Dividing the flux by the aquifer porosity (Figure 3-3) gives an average ground water velocity. Travel time is computed as the distance between the two points of interest (they must both lie on the same flow line) divided by the average velocity.

3. What changes in hydraulic gradient (mound configuration) will be required to convey the proposed quantity of percolate away from beneath the area of application? Methods of answering this question are presented in Section 5.7.2.

The field data and hydrogeologic estimates required to answer these questions include:

1. Geometry of the flow system, including but not limited to
 - a. Depth to ground water
 - b. Depth to impermeable barrier; generally taken to be any layer which has a hydraulic conductivity less than 10% of that of the overlying deposits [35].
 - c. Geometry of the recharge (application) area.
2. Hydraulic gradient - computed from water levels in several observation wells (assuming only horizontal flow), knowing distances between wells.
3. Specific yield (see Section 3.3.3). In some areas of the United States, the SCS has investigated the soil profiles sufficiently to provide an estimate of specific yield for a particular site [5].
4. Hydraulic conductivity in the horizontal direction. Field measurement of this parameter by the auger-hole method is covered in the following section.

3.6.2.1 Horizontal Hydraulic Conductivity

Horizontal conductivity cannot be assumed from a knowledge of vertical conductivity (Section 3.5). In field soils, isotropic conditions are rarely encountered, although they are frequently assumed for the sake of convenience. "Apparent" anisotropic conductivity often occurs in unconsolidated media because of interbedding of fine-grained and coarse-grained materials within the profile. Such interbedding restricts vertical flow much more than it does lateral flow [25]. Although the interbedding represents nonhomogeneity, rather than anisotropy, its effects on the conductivity of a large sample of aquifer material may be approximated by treating the "aquifer" as homogeneous but anisotropic. A considerable amount of data is available on the calculated or measured relationships between vertical

and horizontal permeability for specific sites. The possible spread of ratios is indicated in Table 3-5, which is based on field measurements in glacial outwash deposits (Sites 1-5) [36] and in a river bed (Site 6) [37]. Both authors claim, with justification, that the reported values would not likely be observed in any laboratory tests with small quantities of disturbed aquifer material.

TABLE 3-5
MEASURED RATIOS OF HORIZONTAL TO
VERTICAL CONDUCTIVITY [36, 37]

Site	Effective horizontal permeability, K_h , m/d	K_h/K_v	Remarks
1	42	2.0	Silty
2	75	2.0	--
3	56	4.4	--
4	100	7.0	Gravelly
5	72	20.0	Near terminal moraine
6	72	10.0	Irregular succession of sand and gravel layers (from K measurements in field)
6	86	16.0	(From analysis of recharge flow system)

It is apparent that if accurate information regarding horizontal conductivity is required for an analysis, field measurements will be necessary. Of the many field measurement techniques available, the most useful is the auger hole technique [38]. Details of the test technique may also be found in [1, 9, 30, 34]. Although auger hole measurements are certainly influenced by the vertical component of flow, studies have demonstrated that the technique primarily measures the horizontal component [39]. A definition sketch of the measurement system is shown in Figure 3-16 and the experimental setup is shown in Figure 3-17. The technique is based on the fact that if the hole extends below the water table and water is quickly removed from the hole (by bailing or pumping), the hole will refill at a rate determined by the conductivity of the soil, the dimensions of the hole, and the height of water in the hole. With the aid of either formulas or graphs, the conductivity is calculated from measured rates of rise in the hole. The total inflow into the hole should be sufficiently small during the period of measurement to permit calculation of the conductivity based on an "average" hydraulic head. This is usually the case.

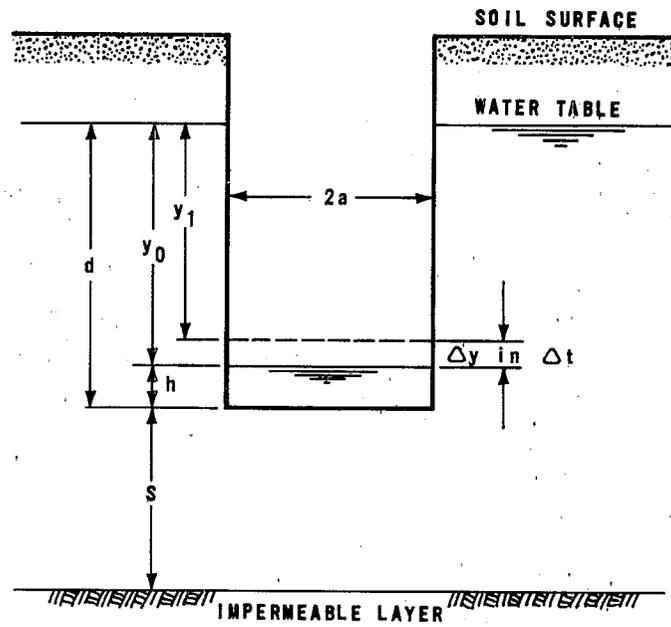

FIGURE 3-16
DEFINITION SKETCH FOR AUGER-HOLE TECHNIQUE

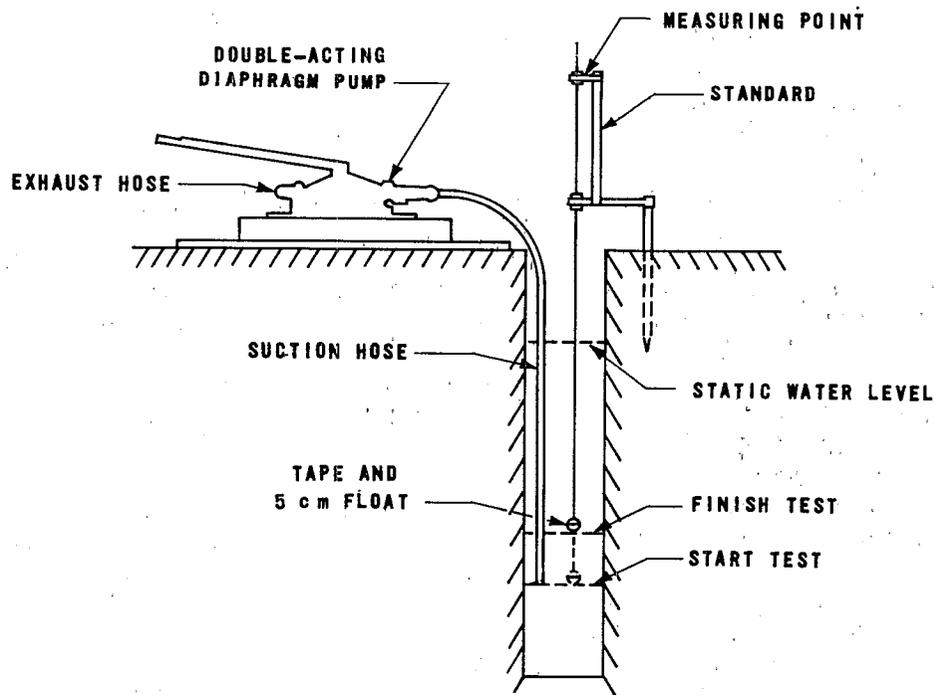

FIGURE 3-17
EXPERIMENTAL SETUP FOR AUGER-HOLE TECHNIQUE

In the formulas and graphs that have been derived, the soil is assumed to be homogeneous and isotropic. However, a modification of the basic technique [39] allows determination of the horizontal and vertical components (K_h and K_v in anisotropic soils by combining auger hole measurements with piezometer measurements at the same depth. If the auger hole terminates at (or in) an impermeable layer, the following equation applies (refer to Figure 3-16 for symbols):

$$K_h = 523,000a^2 \frac{\log_{10}(y_0/y_1)}{\Delta t} \quad (3-6)$$

where a = auger hole radius, m
 Δt = time for water to rise y , s
 K_h = horizontal conductivity, m/d
 y_0, y_1 = depths defined in Figure 3-16, any units, usually cm

If an impermeable layer is encountered at a great depth below the bottom of the auger hole, the equation becomes:

$$K_h = \left(\frac{1,045,000 da^2}{(2d + a)} \right) \cdot \left(\frac{\log_{10}(y_0/y_1)}{\Delta t} \right) \quad (3-7)$$

where d = depth of auger hole, m

Charts for both cases are available in references [29, 34]. An alternative formula, claimed to be slightly more accurate, has been developed [40]. This equation employs a table of coefficients to account for depth of impermeable or of very permeable material below the bottom of the hole.

There are several other techniques for evaluating horizontal conductivity in the presence of a water table. Slug tests, such as described in reference [41] can be used to calculate K_h from the Thiem equation after observing the rate of rise of water in a well following an instantaneous removal of a volume of water to create a hydraulic gradient. Pumping tests, which are already familiar to many engineers, would certainly provide a meaningful estimate. A comprehensive discussion of pumping tests, as well as other ground water problems is presented in reference [42]; example problems

and tables of the mathematical functions needed to evaluate conductivity from drawdown measurements are also presented.

There are some limitations to full-scale pumping tests. The first is the expense involved in drilling and installation. Thus, if a well is not already located on the site, the pumping test technique would probably not be considered. If an existing production well fulfills the conditions needed for the technique to be valid, it should probably be used to obtain an estimate. However, this estimate may still require modification through the use of supplementary "point" determinations, especially if the site is very large or if the soils are quite heterogeneous.

Measurement of horizontal conductivity may occasionally be necessary in the absence of a water table. A typical case might involve the presence of a caliche layer or other hardpan formation near the surface. If the layer was restrictive enough to vertical flow, a perched water table would result upon application of wastewater. In such cases, the mound height analysis described in Section 5.7.2 should be used to determine whether perching would be a problem. Although mounding calculations are presented in Chapter 5 (dealing with RI), it is quite possible that mounding may occur beneath SR systems as well. The user of this manual should be aware of this possibility. The analysis requires an estimate of the horizontal conductivity. Either a modified version of the double-tube technique described in Section 3.5.1 [31] or the shallow well pump-in test [1, 9, 30] can be used to estimate K_h . The latter of these two testing methods is, in principle, the reverse of the auger-hole test.

3.6.2.2 Percolate/Ground Water Mixing

An analysis of the mixing of percolate with native ground water is needed for SR or RI systems that discharge to ground water if the quality of this mixture as it flows away from the site boundaries is to be determined. The concentration of any constituent in this mixture can be calculated as follows:

$$C_{mix} = \frac{C_p Q_p + C_{gw} Q_{gw}}{Q_p + Q_{gw}} \quad (3-8)$$

where C_{mix} = concentration of constituent in mixture

C_p = concentration of constituent in percolate

Q_p = flow of percolate

C_{gw} = concentration of constituent in ground water

Q_{gw} = flow of ground water

The flow of ground water can be calculated from Darcy's Law (Equation 3-1) if the gradient and horizontal hydraulic conductivity are known. This is not the entire ground water flow, but only the flow within the mixing depth. Relationships of the percolate flow and concentrations of constituents are discussed in Chapters 4 and 5. Equation 3-8 is valid if there is complete mixing between the percolate and the native ground water. This is usually not the case. Mixing in the vertical direction may be substantially less than mixing in the horizontal direction.

An alternative approach to estimating the initial dilution is to relate the diameter of the mound developed by the percolate to the diameter of the application area. This ratio has been estimated to be 2.5 to 3.0 [43, 44]. This ratio indicates the relative spread of the percolate and can be used to relate the mixing of percolate with ground water. Thus, an upper limit of 3 for the dilution ratio can be used when ground water flow is substantially (5 to 10 times) more than the percolate flow. If the ground water flow is less than 3 times the percolate flow, the actual ground water flow should be used in Equation 3-8.

3.6.3 Ground Water Quality

It is recommended that where a water table is known to exist that could possibly be impacted by the project, that baseline ground water quality data be collected. The details of number, location, depth, etc. of sampling wells are best left until after a preliminary hydrogeologic study of the site has been completed. Then following reasonably well established guidelines [23, 45, 46, 47], sampling wells may be designed in something approaching an optimum manner.

The parameters that should be measured in samples taken from the ground water are those specified under the "National Interim Primary Drinking Water Regulations" [48]. An exception is made for nondrinking water aquifers or where more stringent state regulations apply.

3.7 Soil Chemical Properties

The chemical composition of the soil is the major factor affecting plant growth and a significant determining factor

in the capacity of the soil to renovate wastewater. There are 16 elements known to be essential for crop growth. Three of these--nitrogen, phosphorus, and potassium--are deficient in many soils. Secondary and micronutrient deficiencies are found less often with sulfur, zinc, and boron being the most common. Soil pH and salinity can limit crop growth and sodium can reduce soil permeability. Chemical properties should be determined prior to design to evaluate the capacity of the soil to support plant growth and to renovate wastewater. Soils should be monitored during operation to avoid detrimental changes in soil chemistry.

3.7.1 Interpretation of Soil Chemical Tests

Several chemical properties, having nothing directly to do with nutrient status, are nonetheless important. Soil pH has a significant influence on the solubility of various compounds, the activities of various microorganisms, and the bonding of ions to exchange sites. Relative to this last phenomenon, soil clays and organic matter (known collectively as the soil colloids), are negatively charged. Thus, they are able to adsorb cations from the soil solution. Cations adsorbed in this way are called exchangeable cations. They can be replaced by other cations from the soil solution without appreciably altering the structure of the soil colloids. The quantity of exchangeable cations that a particular soil can adsorb is known as cation exchange capacity (CEC) and is measured in terms of milliequivalents per 100 grams (meq/100 g) of soil. The percentage of the CEC that is occupied by a particular cation is called the percent saturation for that cation. The sum of the exchangeable Na, K, Ca and Mg expressed as a percentage of the CEC is called percent base saturation.

There are optimum ranges for percent base saturation for various crop and soil type combinations. Also, for a given percent base saturation, it is desirable that Ca and Mg be the dominant cations rather than K and (especially) Na. High percentages of the alkali metals, in particular Na, will create severe problems in many fine-texture soils. The exchangeable sodium percentage (ESP) should be kept below 15% (Section 4.9.1.4). It is important to realize that regardless of the cation distribution in a natural soil, it can be altered readily as a result of agricultural practices. Both the quality of the irrigation water and the use of soil amendments, such as lime or gypsum, can change the distribution of exchangeable cations.

Another chemical property affecting plant growth is salinity, the concentration of soluble ionic substances. It is salinity in the soil solution in the root zone that is of primary interest. Unfortunately, there is no simple relation between this quantity and the salinity of the irrigation water, the salt balance being complicated by moisture transfers through evapotranspiration and deep percolation. The diagnostic tool usually employed is a check on the electrical conductivity (EC) of the irrigation water and the soil solution. Guidelines exist for various types of crops according to their salt tolerance. Procedures for computing the deep percolation (leaching requirement) needed to control root zone salinity are given in references [9, 29].

Because of the variable nature of the soil, few standard procedures for chemical analysis of soil have been developed. Several references that describe analytical methods are available [49, 50, 51]. A complete discussion of analytical methods and interpretation of results for the purpose of evaluating the soil nutrient status is presented in reference [52]. The significance of the major chemical properties is summarized in Table 3-6.

3.7.2 Phosphorus Adsorption Test

Adsorption isotherms for phosphorus can be developed to predict the removal of phosphorus by the soil. Samples of soil are taken into the laboratory and are added to solutions containing known concentrations of phosphorus. Concentrations normally range from 1 to 30 mg/L. After the soil is mixed into the solutions and allowed to come into equilibrium for a period of time (up to several days), the solution is filtered and the filtrate is tested for phosphorus. The difference between the initial and final solution concentrations is the amount adsorbed for a given time. Details of the test are available in reference [53].

A procedure for using adsorption isotherm data to estimate phosphorus retention by soils is suggested in reference [47]. An important consideration discussed is the possibility of slow reactions between phosphorus and cations present in the soil which may "free up" previously used adsorption sites for additional phosphorus retention. Calculations involving adsorption isotherm data, which ignore these reactions, greatly underestimate phosphorus retention.

TABLE 3-6
INTERPRETATION OF SOIL CHEMICAL TESTS

Test result	Interpretation
pH of saturated soil paste	
<4.2	Too acid for most crops to do well
5.2-5.5	Suitable for acid-tolerant crops
5.5-8.4	Suitable for most crops
>8.4	Too alkaline for most crops, indicates a possible sodium problem
CEC, meq/100 g	
1-10	Sandy soils (limited adsorption)
12-20	Silt loam (moderate adsorption)
>20	Clay and organic soils (high adsorption)
Exchangeable cations, % of CEC	
Desirable range	
Sodium	≤5
Calcium	60-70
Potassium	5-10
ESP, % of CEC	
<5	Satisfactory
>10	Reduced permeability in fine-textured soils
>20	Reduced permeability in coarse-textured soils
EC, mmhos/cm at 25° of saturation extract	
<2	No salinity problems
2-4	Restricts growth of very salt-sensitive crops
4-8	Restricts growth of many crops
8-16	Restricts growth of all but salt-tolerant crops
>16	Only a few very salt-tolerant crops make satisfactory yields

3.8 References

1. Bower, H. Groundwater Hydrology. McGraw-Hill Book Co. New York. 1978.
2. Freeze, R.A., and J.A. Cherry. Groundwater. Prentice-Hall. Englewood Cliffs, N.J. 1979.
3. Taylor, S.A. and Q.L. Ashcroft. Physical Edaphology. W.H. Freeman & Co. San Francisco. 1972.
4. Richards, L.A. Physical Condition of Water in Soil. In: Methods of Soil Analysis. Part 1, Agronomy 9. Black, C.A. (ed.). Madison, Wisconsin. American Society of Agronomy, Inc. 1965. pp. 131-136.

5. O'Neal, A.M. A Key for Evaluating Soil Permeability by Means of Certain Field Clues. In: Proceedings Soil Science Society of America. 16:312-315. 1952.
6. Jarrett, A.R. and D.D. Fritton. Effect of Entrapped Soil Air on Infiltration. Transcripts of American Society of Agricultural Engineers. 21:901-906. 1978.
7. Parr, J.F. and A.R. Bertrand. Water Infiltration into Soils. In: Advances in Agronomy. Norman, A.G. (ed.). New York, Academic Press. 1960. pp. 311-363.
8. Todd, D.K. Groundwater. In: Handbook of Applied Hydrology. Chow, V.T. (ed.). McGraw-Hill Book Co. New York. 1964.
9. Drainage Manual. U.S. Department of the Interior, Bureau of Reclamation. 1st Edition. 1978.
10. Childs, E.C. An Introduction to the Physical Basis of Soil Water Phenomena. John Wiley and Sons, Ltd. London. 1969.
11. Duke, H.R. Capillary Properties of Soils - Influence upon Specific Yield. Transcripts of the American Society of Agricultural Engineers. 15:688-691. 1972.
12. Klute, A. Soil Water Flow Theory and its Application in Field Situations. In: Field Soil Water Regime. Special Publication, Series No. 5. Madison, Wisc., Soil Science Society of America. 1973. pp. 9-35.
13. Kirkham, D. and W.L. Powers. Advanced Soil Physics. New York, Wiley-Interscience. 1972. 534 p.
14. Burgy, R.H. and J.N. Luthin. A Test of the Single - and Double - Ring Types of Infiltrimeters. Transcripts of American Geophysical Union. 37:189-191. 1956.
15. Manual of Septic Tank Practice. U.S. Public Health Service. Publication No. 526. U.S. Government Printing Office. 1969. 85 p.
16. Wallace, A.T., et al. Rapid Infiltration Disposal of Kraft Mill Effluent. In: Proceedings of the 30th Industrial Waste Conference, Purdue University, Indiana. 1975.

17. Abele, G., et al. Infiltration Characteristics of Soils at Apple Valley, Minn.; Clarence Cannon Dam, Mo.; and Deer Creek Lake, Ohio, Land Treatment Sites. Special Report 80-36. U.S. Army Cold Regions Research and Engineering Laboratory, Hanover, N.H. 1980. 52 p.
18. U.S. Army Corps of Engineers. Simplified Field Procedures for Determining Vertical Moisture Flow Rates in Medium to Fine Textured Soils. Engineer Technical Letter. 1980. 21 p.
19. Bouwer, H. Cylinder Infiltrimeters. In: Monograph on Methods of Soil Analysis. American Society of Agronomy. (In press). 1981.
20. Haise, H.R., et al. The Use of Cylinder Infiltrimeters to Determine the Intake Characteristics of Irrigated Soils. U.S. Dept. of Agriculture, Agric. Research Service. Public No. 41-7. 1956.
21. Hills, R.C. Lateral Flow Under Cylinder Infiltrimeters. A Graphical Correction Procedure. Journal of Hydrology. 13:153-162. 1971.
22. Youngs, E.G. Two- and Three-Dimensional Infiltration: Seepage from Irrigation Channels and Infiltrimeter Rings. Journal of Hydrology. 15:301-315. 1972.
23. Parizek, R.R. Site Selection Criteria for Wastewater Disposal - Soils and Hydrogeologic Considerations. In: Recycling Treated Municipal Wastewater and Sludge Through Forest and Cropland. Sopper, W.E. and L.T. Kardo (eds.). Pennsylvania State University Press. 1973. pp. 95-147.
24. Tovey, R. and C.H. Pair. A Method for Measuring Water Intake Rate Into Soil for Sprinkler Design. In: Proceedings of the Sprinkler Irrigation Assoc. Open Technical Conference. 1963. pp. 109-118.
25. Bouwer, H. Planning and Interpreting Soil Permeability Measurements. In: Proceedings American Society of Civil Engineers. Journal of the Irrigation and Drainage Division. 28:IR3:391-402. 1969.
26. Rogowski, A.S. Watershed Physics: Soil Variability Criteria. Water Resources Research. 8:1015-1023. 1972.
27. Nielson, D.R., J.W. Biggar and K.T. Erb. Spatial Variability of Field-Measured Soil-Water Properties. Hilgardia. 42:215-259. 1973.

28. Frevert, R.K. and D. Kirkham. A Field Method for Measuring the Permeability of Soil Below a Water Table. In: Proceedings of Highway Research Board. 48:433-422. 1948.
29. Luthin, J.N. Drainage Engineering, Huntington, New York, R.E. Krieger Publ. Co. First edition - reprinted with corrections. 1973. 250 p.
30. Boersma, L. Field Measurement of Hydraulic Conductivity Above a Water Table. In: Methods of Soil Analysis. Part 1, Agronomy 9. Black, C.A. (ed). Madison, Wisconsin. American Society of Agronomy, Inc. 1965. pp. 234-252.
31. Bouwer, H. and R.C. Rice. Modified Tube Diameters for the Double-Tube Apparatus. In: Proceedings Soil Science Society of America. 31:437-439. 1967
32. Bouwer, H. Rapid Field Measurement of Air Entry Value and Hydraulic Conductivity of Soil as Significant Parameters in Flow System Analysis. Water Resources Research. 2:729-738. 1966.
33. Topp, G.C. and M.R. Binns. Field Measurements of Hydraulic Conductivity with a Modified Air-Entry Permeameter. Canadian Journal Soil Science. 56:139-147. 1976.
34. Drainage of Agricultural Land. U.S. Dept. of Agriculture - Soil Conservation Service National Engineering Handbook. Section 16. May 1971.
35. Van Beers, W.F.J. The Auger Hole Method - A Field Measurement of the Hydraulic Conductivity of Soil Below a Water Table. Wageningen, The Netherlands. International Inst. for Land Reclamation and Improvement, Bulletin 1. 1958.
36. Weeks, E.P. Determining the Ratio of Horizontal to Vertical Permeability by Aquifer-Test Analysis. Water Resources Research. 5:196-214. 1969.
37. Bouwer, H. Ground Water Recharge Design for Renovating Waste Water. In: Proceedings of American Society of Civil Engineers, Journal of the Sanitary Engineering Division. 96:SA 1:59-73. 1970.
38. Van Bavel, C.H.M. and D. Kirkham. Field Measurement of Soil Permeability Using Auger Holes. In: Proceedings Soil Science Society of America. 13:90-96. 1948.

39. Maasland, M. Measurement of Hydraulic Conductivity by the Auger Hole Method in Anisotropic Soil. In: Proceedings Soil Science Society of America. 19:379-388. 1955.
40. Boast, C.W. and D. Kirkham. Auger Hole Seepage Theory. In: Proceedings Soil Science Society of America. 35:365-373. 1971.
41. Bouwer, H. and R.C. Rice. A Slug Test for Determining Hydraulic Conductivity of Unconfined Aquifers with Completely or Partially Penetrating Wells. Water Resources Research. 12:423-428. 1976.
42. Glover, R.E. Ground-Water Movement. U.S. Bureau of Reclamation, Water Resources. Technical Publication Engineering Monograph No. 31. 1964.
43. Singh, R. Prediction of Mound Geometry Under Recharge Basins. Water Resources Research. 12:775-780. 1976.
44. Marino, M.A. Artificial Groundwater Recharge, I. Circular-Recharging Area. Journal of Hydrology. 25:201-208. 1975.
45. Smith, J.L. et al. Mass Balance Monitoring of Land Application Sites for Wastewater Residuals. Transcript of American Society of Agricultural Engineers. 20:309-312. 1977.
46. Blakeslee, P. Monitoring Considerations for Municipal Wastewater Effluent and Sludge Application to the Land. In: Proceedings of the Joint Conference on Recycling Municipal Sludges and Effluents on Land. Champaign, Illinois. 1973. pp. 183-198.
47. Loehr, R.C., et al. Land Application of Wastes, Vols. I & II. New York. Van Nostrand Reinhold Co. 1979.
48. National Interim Primary Drinking Water Regulations. U.S. Environmental Protection Agency, Office of Water Supply. EPA-570/9-76-003. 1976. 159 p.
49. Black, C.A. (ed.). Methods of Soil Analysis, Part 2: Chemical and Microbiological Properties. Agronomy 9, American Society of Agronomy. Madison. 1965.
50. Richards, L.A. (ed.). Diagnosis and Improvement of Saline and Alkali Soil. Agricultural Handbook 60. U.S. Department of Agriculture. 1954.

51. Jackson, M.L. Soil Chemical Analysis. Englewood Cliffs, N.J. Prentice-Hall, Inc. 1958.
52. Walsh, L.M. and J.D. Beaton, (eds.). Soil Testing and Plant Analysis. Madison, Soil Science Society of America. 1973.
53. Fox, R.L. and E.J. Kamprath. Phosphate Sorption Isotherms for Evaluating the Phosphate Requirements of Soil. In: Proceedings Soil Science Society of America. 34:902-906. 1970.

CHAPTER 4

SLOW RATE PROCESS DESIGN

4.1 Introduction

The key elements in the design of slow rate (SR) systems are indicated in Figure 4-1. Important features are: (1) the iterative nature of the procedure, and (2) the input information that must be obtained for detailed design.

Determining the design hydraulic loading rate is the most important step in process design because this parameter is used to determine the land area required for the SR system. The design hydraulic loading rate is controlled by either soil permeability or nitrogen limits for typical municipal wastewater. Crop selection is usually the first design step because preapplication treatment, hydraulic and nitrogen loading rates, and storage depend to some extent on the crop. Preapplication treatment selection usually precedes determination of hydraulic loading rate because it can affect the wastewater nitrogen concentration and, therefore, the nitrogen loading.

4.2 Process Performance

The mechanisms responsible for treatment and removal of wastewater constituents such as BOD, suspended solids (SS), nitrogen, phosphorus, trace elements, microorganisms, and trace organics are discussed briefly. Levels of removal achieved at various SR sites are included to show how removals are affected by loading rates, crop, and soil characteristics. Chapter 9 contains discussion on the health and environmental effects of these constituents.

4.2.1 BOD and Suspended Solids Removal

BOD and SS are removed by filtration and bacterial action as the applied wastewater percolates through the soil. BOD and SS are normally reduced to concentrations of less than 2 mg/L and less than 1 mg/L, respectively, following 1.5 m (5 ft) of percolation. Typical loading rates of BOD and SS for municipal wastewater SR systems, regardless of the degree of preapplication treatment, are far below the loading rates at which performance is affected (see Section 2.2.1.1). Thus, loading rates for BOD and SS are normally not a concern in the design of SR systems. Removals of BOD achieved at five selected sites are presented in Table 4-1.

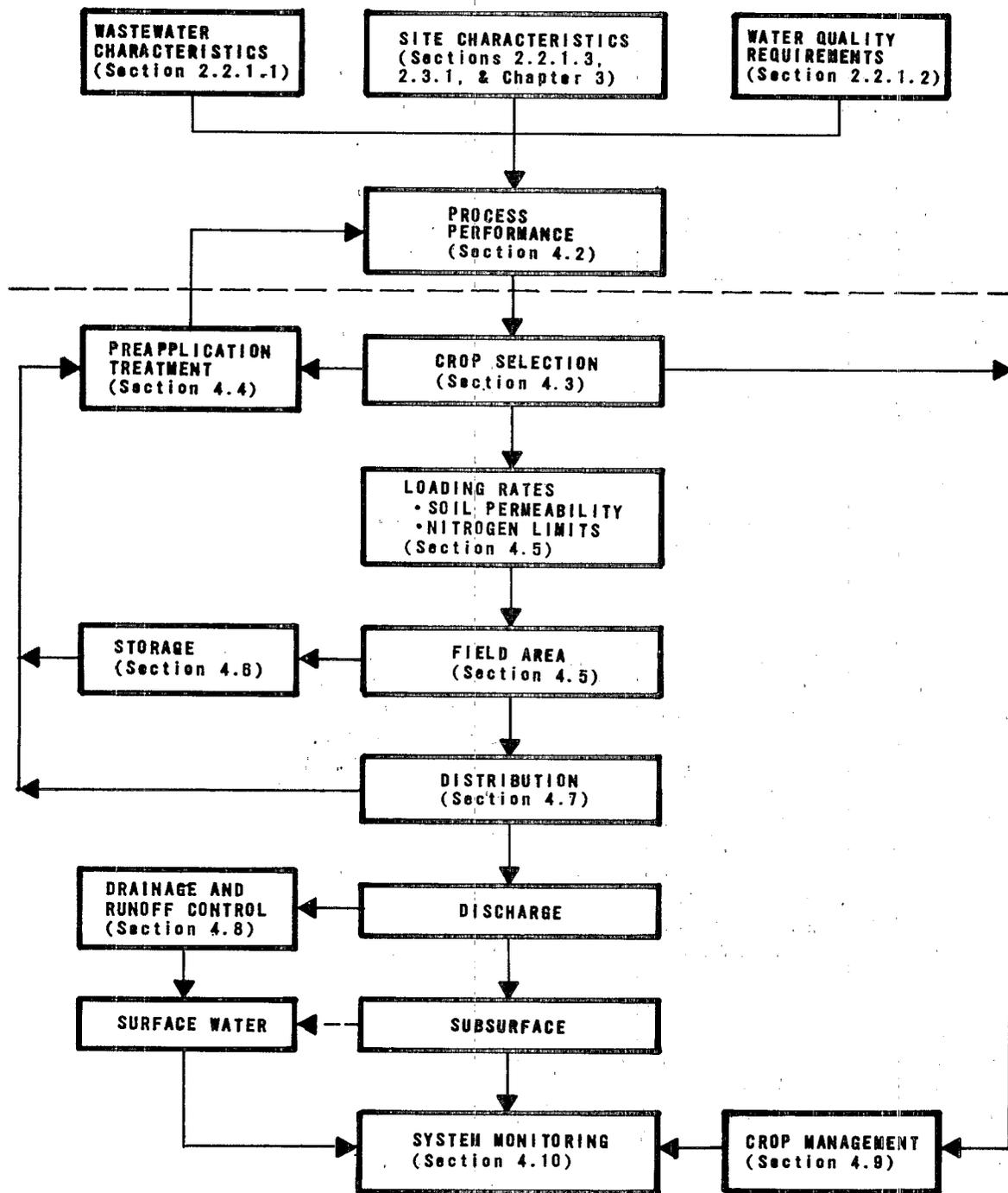

FIGURE 4-1
SLOW RATE DESIGN PROCEDURE

TABLE 4-1
BOD REMOVAL DATA
FOR SELECTED SR SYSTEMS [1-5]

Location	Annual waste-water loading rate, cm/yr	Surface soil	BOD			Sampling depth, m
			Concentration in applied wastewater, mg/L	Concentration in treated water, mg/L	Removal, %	
Dickinson, North Dakota	140	Sandy loams and loamy sands	42	<1	>98	<5
Hanover, New Hampshire	130-780	Sandy loam and silt loam	40-92	0.9-1.7	96-98	1.5
Muskegon, Michigan	130-260	Sands and loamy sands	24	1.3	94	4
Roswell, New Mexico	80	Silty clay loams	42	<1	>98	<30
San Angelo, Texas	290	Clay and clay loam	89	0.7	99	2.1

Note: See Appendix G for metric conversions.

4.2.2 Nitrogen

For SR systems located above potable aquifers, nitrogen concentration in percolate must be low enough that ground water quality at the project boundary can meet drinking water nitrate standards. Nitrogen removal mechanisms at SR systems include crop uptake, nitrification-denitrification, ammonia volatilization, and storage in the soil. Percolate nitrogen concentrations less than 10 mg/L can be achieved with SR systems if the nitrogen loading rate is maintained within the combined removal rates of these mechanisms. The nitrogen removal rates and loading rate are, therefore, important design parameters. Percolate nitrogen levels achieved at selected SR sites are given in Table 4-2.

Crop uptake is normally the primary nitrogen removal mechanism operating in SR systems. The amount of nitrogen removed by crop harvest depends on the nitrogen content of the crop and the crop yield. Annual nitrogen uptake rates for specific crops are given in Section 4.3.2.1. Maximum nitrogen removal can be achieved by selecting crops or crop combinations with the highest nitrogen uptake potential.

TABLE 4-2
NITROGEN REMOVAL DATA FOR SELECTED
SR SYSTEMS [1, 3-8]

Location	Total nitrogen concentration in applied wastewater, mg/L as N	Total nitrogen concentration in percolate or affected ground water, mg/L as N	Removal, %	Sampling depth, m	Total nitrogen concentration in background ground water, mg/L as N
Dickinson, North Dakota	11.8	3.9	67	11	1.9
Hanover, New Hampshire	27-28	7.3	72	1.5	--
Helen, Georgia ^a	18.0	3.5	80	1.2	0.17
Roswell, New Mexico	66.2	10.7	84	30	2.2
San Angelo, Texas	35.4	6.1	83	10	--

a. Forest system. All others are agricultural systems.

Nitrogen loss by denitrification depends on several environmental factors including the oxygen level in the soil. Assuming that most of the applied nitrogen is in the organic or ammonium form, increased nitrogen removal due to denitrification can be expected under the following conditions:

- High levels of organic matter in the soil and/or wastewater, such as the concentrations found in primary effluent
- High soil cation exchange capacity--a characteristic of fine-textured and organic soils.
- Neutral to slightly alkaline soil pH
- Alternating saturated and unsaturated soil moisture conditions
- Warm temperatures

Denitrification losses typically are in the range of 15 to 25% of the applied nitrogen, although measured losses have ranged from 3 to 70% [4, 9]. The range of 15 to 25% should be used for conservative design. When conditions are favorable, the maximum rate may be used. Lower values should be used when conditions are less favorable.

Ammonia volatilization losses can be significant (about 10%) if the soil pH is above 7.8 and the cation exchange capacity

is low (sandy, low organic soils). For design, volatilization losses may be considered included in the 15 to 25% used for denitrification.

Storage of nitrogen in the soil through plant uptake and subsequent conversion of roots and unharvested residues into soil humus can account for nitrogen retention rates up to 225 kg/ha·yr (200 lb/acre·yr) in soils of arid regions initially low in organic matter (less than 2%). In contrast, nitrogen storage will be near zero for soils rich in organic matter. In either case, if nitrogen input remains constant, the rate of nitrogen storage will decrease with time because the rate of decay and release of nitrogen increases with the concentration of soil organic nitrogen. Eventually, an equilibrium level of organic nitrogen may be obtained and net storage then ceases. Therefore, for design purposes, the most conservative approach is to assume net storage will be zero.

4.2.3 Phosphorus

Phosphorus is removed primarily by adsorption and precipitation (together referred to as sorption) reactions in the soil. Crop uptake can account for phosphorus removals in the range of 20 to 60 kg/ha·yr (18 to 53 lb/acre·yr), depending on the crop and yield (Section 4.3.2.1). Percolate phosphorus concentrations at several SR sites are presented in Table 4-3.

The phosphorus sorption capacity of a soil profile depends on the amounts of clay, aluminum, iron, and calcium compounds present and the soil pH. In general, fine textured mineral soils have the highest phosphorus sorption capacities and coarse textured acidic or organic soils have the lowest.

For systems with coarse textured soils and limits on the concentration of percolate phosphorus, a phosphorus adsorption test should be conducted using soil from the selected site. This test, described in Section 3.7.2, determines the amount of phosphorus that the soil can remove during short application periods. Actual phosphorus retention at an operating system will be at least 2 to 5 times the value obtained during a 5 day adsorption test [13].

TABLE 4-3
PHOSPHORUS REMOVAL DATA FOR TYPICAL
SR SYSTEMS [1,2,4,5,7,8,10-12]

Location	Annual waste-water loading rate, cm/yr	Surface soil	PO ₄ concentration in applied wastewater, mg/L as P	Soluble PO ₄ concentration in affected ground water, mg/L as P	Removal, %	Sampling depth, m	Distance from application site, m	Soluble PO ₄ concentration in background ground water, mg/L as P
Agricultural systems								
Camarillo, California	160	Clay loams and sandy loams	11.8 ^a 11.8 ^a	2.8 ^a 0.2 ^a	76 ^a 98 ^a	1 3	0 0	3.0 ^a --
Dickinson, North Dakota	140	Sandy loams and loamy sands	6.9 ^a	0.05 ^a	99 ^a	<5	30-150	0.04 ^a
Hanover, New Hampshire	130-78	Sandy loam and silt loam	7.3-7.6 ^a	0.03-0.07 ^b	99.0-99.5	1.5	0	--
Mesa, Arizona	400-860	Loamy sands and sandy loams	9.0 ^b 9.0 ^b	5.0 ^b 4.2 ^b	44 ^b 53 ^b	0.5 1	0 0	1.0 ^b 3.6 ^b
Muskegon, Michigan	130-260	Sands and loamy sands	1.0-1.3 ^a	0.03-0.05 ^a	95-98 ^a	1.5	0	0.03 ^a
Roswell, New Mexico	80	Silty clay loams	7.95 ^a	0.39 ^a	95 ^a	<6	0	0.55 ^a
Tallahassee, Florida	520	Sand	10.5 ^a 10.5 ^a	0.1 ^a 0.0 ^a	>99 ^a >99 ^a	1.2 10.7	0 0	0.02 ^a 0.02 ^a
Forest systems								
Helen, Georgia	380	Sandy loam	13.1 ^a	0.22 ^a	98 ^a	1.2	0	0.21 ^a
State College, Pennsylvania (Penn State University)	260	Sandy loams and clay loams	7.7 ^b	0.08 ^b	99 ^b	1.2	0	0.03 ^b

a. Total phosphate concentration.

b. Orthophosphate concentration.

For purposes of design and operation, the soil profile can be considered to have a finite phosphorus sorption capacity associated with each layer. Eventually, the sorption capacity of the entire soil profile may reach saturation and soluble phosphorus will appear in the percolate. In cases where effluent quality requirements limit the concentration of phosphorus in the percolate, the useful life of the SR system may be limited by the phosphorus sorption capacity of the soil profile. An empirical model to predict the useful life of an SR system has been developed [9].

4.2.4 Trace Elements

Trace element removal in the soil is a complex process involving the mechanisms of adsorption, precipitation, ion exchange, and complexation. Because adsorption of most trace elements occurs on the surfaces of clay minerals, metal oxides, and organic matter, fine textured and organic soils have a greater adsorption capacity for trace elements than sandy soils.

Removal of trace elements from solution is nearly complete in soils suitable for SR systems. Consequently, trace element removal is not a concern in the design procedure. Performance data from selected SR systems are presented in Table 4-4.

Although some trace elements can be toxic to plants and consumers of plants, no universally accepted toxic threshold values for trace element concentrations in the soil or for mass additions to the soil have been established. Maximum loadings over the life of a system for several trace elements have been suggested for soils having low trace element retention capacities and are presented in Table 4-5.

Toxicity hazards can be minimized by maintaining the soil pH above 6.5. Most trace elements are retained as unavailable insoluble compounds above pH 6.5. Methods for adjusting soil pH are discussed in Section 4.9.1.3.

4.2.5 Microorganisms

Removal of microorganisms, including bacteria, viruses, and parasitic protozoa and helminths (worms), is accomplished by filtration, adsorption, desiccation, radiation, predation, and exposure to other adverse conditions. Because of their large size, protozoa and helminths are removed primarily by filtration at the soil surface. Bacteria also are removed by filtration at the soil surface, although adsorption may be important. Viruses are removed almost entirely by adsorption.

TABLE 4-4
TRACE ELEMENT BEHAVIOR DURING
SR LAND TREATMENT [14]

Element	EPA drinking water standard, mg/L	Raw municipal wastewater concentration, mg/L	Muskegon, Michigan ^a		San Angelo, Texas ^b		Melbourne, Australia ^c	
			Percolate concentration, mg/L	Removal, %	Percolate concentration, mg/L	Removal, %	Percolate concentration, mg/L	Removal, %
Cadmium	0.01	0.004-0.14	<0.002	90	<0.004	-- ^d	0.002	80
Chromium	0.05	0.02-0.7	0.004	90	<0.005	>98	0.03	90
Copper	1.0	0.02-3.4	0.002	90	0.014	85	0.02	95
Lead	0.05	0.05-1.3	<0.050	>40	<0.050	-- ^d	0.01	95
Manganese	0.05	0.11-0.14	0.26	15	--	--	--	--
Mercury	0.002	0.002-0.05	<0.002	-- ^d	--	--	0.0004	85
Zinc	5.0	0.03-83	0.033	95	0.102	25	0.04	95

- a. Data represent average annual concentrations (1975) found in underdrains placed at a depth of 1.5 m below the irrigation site.
- b. Data represent average annual concentrations (November 1975 - November 1976) found in two seepage creeks adjacent to the irrigated area.
- c. Data represent average annual concentrations (1977) found in underdrains placed at depths of 1.2 to 1.8 m below the irrigation site.
- d. Percent removal was not calculated since influent and percolate values are below lower detection limit.

TABLE 4-5
SUGGESTED MAXIMUM APPLICATIONS OF
TRACE ELEMENTS TO SOILS WITHOUT
FURTHER INVESTIGATION^a

Element	Mass application to soil, kg/ha	Typical concentration, mg/L ^b
Aluminum	4,570	10
Arsenic	92	0.2
Beryllium	92	0.2
Boron	680	1.4 ^c
Cadmium	9	0.02
Chromium	92	0.2
Cobalt	46	0.1
Copper	184	0.4
Fluoride	920	1.8
Iron	4,570	10
Lead	4,570	10
Lithium	--	2.5 ^d
Manganese	184	0.4
Molybdenum	9	0.02
Nickel	184	0.4
Selenium	18	0.04
Zinc	1,840	4

- a. Values were based on the tolerances of sensitive crops, mostly fruits and vegetables, grown on soils with low capacities for retaining elements in unavailable forms [15, 16].
- b. Based on reaching maximum mass application in 20 years at an annual application rate of 2.4 m/yr (8 ft/yr).
- c. Boron exhibits toxicity to sensitive plants at values of 0.75 to 1.0 mg/L.
- d. Lithium toxicity limit is suggested at 2.5 mg/L concentration for all crops, except citrus which uses a 0.075 mg/L limit. Soil retention is extremely limited.

As noted in Table 1-3, fecal coliforms are normally absent after wastewater percolates through 1.5 m (5 ft) of soil. Coliform removals at several operating SR systems are shown in Table 4-6. Coliform removal in the soil profile is approximately the same when primary or secondary preapplication treatment is provided [4]. Virus removals are not as well documented. State agencies may require secondary treatment if edible crops are grown or if public contact is unlimited. Microorganism removal is not a limiting factor in the SR design procedure.

TABLE 4-6
COLIFORM DATA FOR SEVERAL
SR SYSTEMS [1,4,5,8,12]

Location	Preapplication treatment	Coliforms	Concentration in applied wastewater, MPN/100 mL	Concentration in percolate or ground water, MPN/100 mL	Distance of travel, m	Concentration in background ground water, MPN/100 mL
Camarillo, California	Activated sludge and disinfection	Total	57 x 10 ³	7 29	0.5 1.0	4 27
		Fecal	220	<2 <2	0.5 1.0	<2 4
Dickinson, North Dakota	Aerated ponds and disinfection	Total	TNTC ^a	12	30-150	1
		Fecal	TNTC ^a	0	30-150	0
Hanover, New Hampshire	Primary	Fecal	1.2 x 10 ⁴ - 3.1 x 10 ⁵	0-1	1.5	--
Mesa, Arizona	Trickling filters	Total	3.09 x 10 ⁶	<2 9	0.5 1.0	20 60
		Fecal	1.05 x 10 ⁵	<2 9	0.5 1.0	<2 25
Roswell, New Mexico	Trickling filters and disinfection	Total	TNTC ^a	TNTC ^a	<6	--
		Fecal	TNTC ^a	52	<6	--

a. At least one sample too numerous to count.

4.2.6 Trace Organics

Trace organics are removed by several mechanisms, including sorption, degradation, and volatilization. One study at Muskegon, Michigan, evaluated the effectiveness of trace organics removal during preapplication treatment (aerated ponds) and SR treatment. Although 59 organic pollutants were identified in the raw wastewater, renovated water from drainage tiles underlying the irrigation site contained only low levels of 10 organic compounds, including two from non-wastewater sources. Benzene, chloroform, and trichloroethylene were monitored for several days; results are shown in Table 4-7.

Results from pilot SR studies at Hanover, New Hampshire, indicate that significant levels of volatile trace organics are removed during sprinkler application [4]. Measurements of chloroform, toluene, methylene chloride, 1,1 dichloroethane, bromodichloromethane, and tetrachloroethylene showed that an average of 65% of these six compounds were volatilized during the sprinkling process, with individual removals ranging from 57% for toluene to 70% for methylene chloride.

TABLE 4-7
 BENZENE, CHLOROFORM, AND TRICHLOROETHYLENE
 IN MUSKEGON WASTEWATER TREATMENT SYSTEM [17]

Pollutant	Sampling point ^b	Concentration, µg/L ^a				
		8/10/76	8/11/76	8/12/76	9/7/76	9/8/76
Benzene	1	6	53	6	41	32
	2	7	2	<1	8	5
	3	<1	<1	<1	3	2
	4	<1	<1	<1	<1	8
Chloroform	1	425	440	480	360	2,645
	2	105	61	81	365	610
	3	12	9	4	100	75
	4	3	3	1	13	10
Trichloroethylene	1	13	6	10	110	120
	2	16	3	5	35	33
	3	7	4	1	11	6
	4	6	3	2	10	8

a. Average for duplicate samples.

b. Sampling Point 1 - influent
 Sampling Point 2 - aerated lagoon effluent
 Sampling Point 3 - storage lagoon effluent
 Sampling Point 4 - renovated water from drainage tiles

Based on these results, it appears that a typical SR system is quite effective in removing trace organics. However, if a community's wastewater contains large concentrations of trace organics from industrial contributions, industrial pretreatment should be considered. If hazardous chlorinated trace organics result from wastewater chlorination, the engineer must decide in consultation with regulatory authorities whether it is more important to remove pathogens or to reduce trace organic levels. This decision should take into consideration the type of crop and the method of distribution.

4.3 Crop Selection

The crop is a critical component in the SR process. It removes nutrients, reduces erosion, maintains or increases infiltration rates, and can produce revenue where markets exist.

4.3.1 Guidelines for Crop Selection

Important characteristics or properties of crops that should be considered when selecting a crop for SR systems include: (1) nutrient uptake capacity, (2) tolerance to high soil moisture conditions, (3) consumptive use of water and irrigation requirements, and (4) revenue potential. A relative comparison of these characteristics for several types of crops is presented in Table 4-8 as a general guide

to selection. Characteristics of secondary importance include (1) effect on soil infiltration rate, (2) crop water quality requirements and toxicity concerns, and (3) management requirements.

Most SR systems are designed to minimize land area by using maximum hydraulic loading rates. Crops that are compatible with high hydraulic loading rates are those having high nitrogen uptake capacity, high consumptive water use, and high tolerance to moist soil conditions. Other desirable crop characteristics for this situation are low sensitivity to wastewater constituents, and minimum management requirements. Crops grown for revenue must have a ready local market and be compatible with wastewater treatment objectives.

4.3.1.1 Agricultural Crops

Agricultural crops most compatible with the objective of maximum hydraulic loading are the forage and turf grasses. Forage crops that have been used successfully include: Reed canarygrass, tall fescue, perennial ryegrass, Italian ryegrass, orchardgrass, and bermudagrass. If forage utilization and value are not a consideration, Reed canarygrass is often a first choice in its area of adaptation because of high nitrogen uptake rate, winter hardiness, and persistence. However, Reed canarygrass is slow to establish and should be planted initially with a companion grass (ryegrass, orchardgrass, or tall fescue) to provide good initial cover.

Of the perennial grasses grown for forage utilization and revenue under high wastewater loading rates, orchardgrass is generally considered to be more acceptable as animal feed than tall fescue or Reed canarygrass. However, orchardgrass is prone to leaf diseases in the southern and eastern states. Tall fescue is generally preferred as a feed over Reed canarygrass but is not suitable for use in the northern tier of states due to lack of winter-hardiness. Again, other crops may be more suitable for local conditions and advice of local farm advisers or extension specialists will be helpful in making the crop selection.

Corn will grow satisfactorily where the water table depth is about 1.5 to 2 m, (5 to 7 ft) but alfalfa requires naturally well-drained soils and water table depths of at least 3 m (10 ft) for persistence. The alfalfa cultivar selected should be high yielding with resistance to root rot and bacterial wilt in the growing region, especially when high hydraulic loading rates (>7.5 cm/wk or 3 in./wk) are used.

TABLE 4-8
RELATIVE COMPARISON OF CROP
CHARACTERISTICS [Adapted from 18]

	Potential as revenue producer ^a	Potential as water user ^b	Potential as nitrogen user ^c	Moisture tolerance ^d
<u>Field crops</u>				
Barley	Marg	Mod	Marg	Low
Corn, grain	Exc	Mod	Good	Mod
Corn, silage	Exc	Mod	Exc	Mod
Cotton (lint)	Good	Mod	Marg	Low
Grain, sorghum	Good	Low	Marg	Mod
Oats	Marg	Mod	Poor	Low
Rice	Exc	High	Poor	High
Safflower	Exc	Mod	Exc	Mod
Soybeans	Good	Mod	Good-exc ^e	Mod
Wheat	Good	Mod	Good	Low
<u>Forage crops</u>				
Kentucky bluegrass	Good	High	Exc	Mod
Reed canarygrass	Poor	High	Exc	High
Alfalfa	Exc	High	Good-exc ^e	Low
Bromegrass	Poor	High	Good	High
Clover	Exc	High	Good-exc ^e	Mod-high
Orchardgrass	Good	High	Good-exc ^e	Mod
Sorghum-sudan	Good	High	Exc	Mod
Timothy	Marg	High	Good	High
Vetch	Marg	High	Exc	High
Tall fescue	Good	High	Good-exc	High
<u>Turf crops</u>				
Bentgrass	Exc	High	Exc	High
Bermudagrass	Good	High	Exc	High
<u>Forest crops</u>				
Hardwoods	Exc	High	Good-exc ^f	High ^g
Pine	Exc	High	Good ^f	Mod-low ^g
Douglas-fir	Exc	High	Good ^f	Mod

- a. Potential as revenue producers is a judgmental estimate based on nationwide demand. Local market differences may be substantial enough to change a marginal revenue producer to a good or excellent revenue producer and vice versa. Some of the forages are extremely difficult to market due to their coarse nature and poor feed values.
- b. Water user definitions expressed as a fraction of alfalfa consumptive-use.
- | | |
|----------------|----------|
| High | 0.8-1.0 |
| Moderate (Mod) | 0.6-0.79 |
| Low | <0.6 |
- c. Nitrogen user ratings (kg/ha):
- | | |
|-----------------|---------|
| Excellent (Exc) | >200 |
| Good | 150-200 |
| Marginal (Marg) | 100-150 |
| Poor | <100 |
- d. Moisture tolerance ratings:
- | | |
|----------|---|
| High | - withstands prolonged soil saturation >3 days. |
| Moderate | - withstands soil saturation 2-3 days. |
| Low | - withstands no soil saturation. |
- e. Legumes will also take nitrogen from the atmosphere.
- f. Higher nitrogen uptake during juvenile growth stage after crowning.
- g. Species dependent, check with the State Extension Forester.

A mixture of alfalfa and a persistent forage grass, such as orchardgrass, can be used on soils that are not naturally well drained. At high hydraulic loading rates, the alfalfa may not persist over 2 years, but the forage grass will fill in the areas in the thinned alfalfa stand.

The most common agricultural crops grown for revenue using wastewater are corn (silage), alfalfa (silage, hay, or pasture), forage grass (silage, hay, or pasture), grain sorghum, cotton, and grains [18]. However, any crop, including food crops, may be grown with reclaimed wastewater after suitable preapplication treatment.

In areas with a long growing season, such as California, selection of a double crop is an excellent means of increasing the revenue potential as well as the annual consumptive water use and nitrogen uptake of the crop system. Double crop combinations that are commonly used include (1) short season varieties of soybeans, silage corn, or sorghum as a summer crop; and (2) barley, oats, wheat, vetch, or annual forage grass as a winter crop.

A growing practice in the East and Midwest is to provide a continuous vegetative cover with grass and corn. This "no-till" corn management consists of planting grass in the fall and then applying a herbicide in the spring before planting the corn. When the corn completes its growth cycle, grass is reseeded. Thus, cultivation is reduced; water use is maximized; nutrient uptake is enhanced; and revenue potential is increased.

4.3.1.2 Forest Crops

The most common forest crops used in SR systems have been mixed hardwoods and pines. A summary of representative operational systems and types of forest crops used is presented in Table 4-9.

The growth responses of a number of tree species to a range of wastewater loadings are identified in Table 4-10. The high growth response column is most suitable for wastewater application because of nitrogen uptake and productivity. The growth response will vary in accordance with a number of factors; one of the most important is the adaptability of the selected species to the local climate. Local foresters should be consulted for specific judgments on the likely response of selected species.

TABLE 4-9
SUMMARY OF OPERATIONAL FOREST LAND TREATMENT
SYSTEMS IN THE UNITED STATES RECEIVING
MUNICIPAL WASTEWATER

Location	Flow, m ³ /d	Forest type	Date started	Hydraulic loading, cm/wk	Other conditions
Clayton County, Georgia	73,800	Loblolly pine plantation and natural hardwood	1981	6.3	Ground water to be recycled as drinking water
Helen, Georgia	76	Mixed hardwood and pine	1973	7.6	--
Kings Bay Submarine Support Base, St. Marys, Georgia	1,250	Slash pine plantation	1981	1.3	Site drainage with open ditches
Mackinaw City, Michigan	760	Aspen, white pine birch	1976	11.3	Frost free, seasonal application
Mt. Sunapee State Park, Newbury, New Hampshire	26	Mixed hardwood	1971	5.0	Water stored and applied in June and July only
State College, Pennsylvania (Penn State University)	11,350	Mixed hardwood; red pine plantation; spruce, old field	1963	2.0- 7.5	Ground water to be recycled as drinking water
West Dover, Vermont	2,080	Northern hardwoods; balsam, hemlock, spruce in understory	1976	≤6.3	Operates at air temperatures above -18 °C

TABLE 4-10
HEIGHT GROWTH RESPONSE OF SELECTED
TREE SPECIES [Adapted from 19]

Height growth response class		
Low	Intermediate	High
Slash pine	Tulip poplar	Cottonwood
Cherry-laurel	Bald cypress	Sycamore
Arizona cypress	Saw-tooth oak	Green ash
Live oak	Red cedar	Black cherry
Holly	Laurel oak	Sweetgum
Hawthorne	Magnolia	Black locust
Northern white cedar	Nuttall oak	Red bud
Red pine	Cherry bark oak	Catalpa
	Loblolly pine	Chinese elm
	Shortleaf pine	White pine
	Virginia pine	
	Douglas-fir	

4.3.2 Crop Characteristics

Reference data and information on the crop characteristics of (1) nutrient uptake, water quality requirements, and toxicity concerns; (2) water tolerance; (3) consumptive water use; and (4) effect on soil hydraulic properties are presented in this section for both agricultural crops and forest crops.

4.3.2.1 Nutrient Uptake

Agricultural Crops

In general, the largest nutrient removals can be achieved with perennial grasses and legumes that are cut frequently at early stages of growth. It should be recognized that legumes can fix nitrogen from the air, but they are active scavengers for nitrate if it is present. The potential for harvesting nutrients with annual crops is generally less than with perennials because annuals use only part of the available growing season for growth and active uptake. Typical annual uptake rates of the major plant nutrients--nitrogen, phosphorus, and potassium--are listed in Table 4-11 for several commonly selected crops.

The nutrient removal capacity of a crop is not a fixed characteristic but depends on the crop yield and the nutrient content of the plant at the time of harvest. Design estimates of harvest removals should be based on yield goals and nutrient compositions that local experience indicates can be achieved with good management on similar soils.

TABLE 4-11
NUTRIENT UPTAKE RATES FOR
SELECTED CROPS
kg/ha·yr

	Nitrogen	Phosphorus	Potassium
Forage crops			
Alfalfa ^a	225-540	22-35	175-225
Bromegrass	130-225	40-55	245
Coastal bermudagrass	400-675	35-45	225
Kentucky bluegrass	200-270	45	200
Quackgrass	235-280	30-45	275
Reed canarygrass	335-450	40-45	315
Ryegrass	200-280	60-85	270-325
Sweet clover ^a	175	20	100
Tall fescue	150-325	30	300
Orchardgrass	250-350	20-50	225-315
Field crops			
Barley	125	15	20
Corn	175-200	20-30	110
Cotton	75-110	15	40
Grain sorghum	135	15	70
Potatoes	230	20	245-325
Soybeans ^a	250	10-20	30-55
Wheat	160	15	20-45

a. Legumes will also take nitrogen from the atmosphere.

The rate of nitrogen uptake by crops changes during the growing season and is a function of the rate of dry matter accumulation and the nitrogen content of the plant. Consequently, the pattern of nitrogen uptake is subject to many environmental and management variables and is crop specific. Examples of measured nitrogen uptake rates versus time are shown in Figure 4-2 for annual crops and perennial forage grasses receiving wastewater.

The amounts of phosphorus in applied wastewaters are usually much higher than plant requirements. Fortunately, most soils have a high sorption capacity for phosphorus and very little of the excess passes through the soil (see Section 4.2.3).

Potassium is used in large amounts by many crops, but typical wastewater is relatively deficient in this element. In most cases, fertilizer potassium may be needed to provide for optimal plant growth, depending on the soil and crop grown (see Section 4.9.1.2). Other macronutrients taken up by crops include magnesium, calcium and sulfur; deficiencies of these nutrients are possible in some areas.

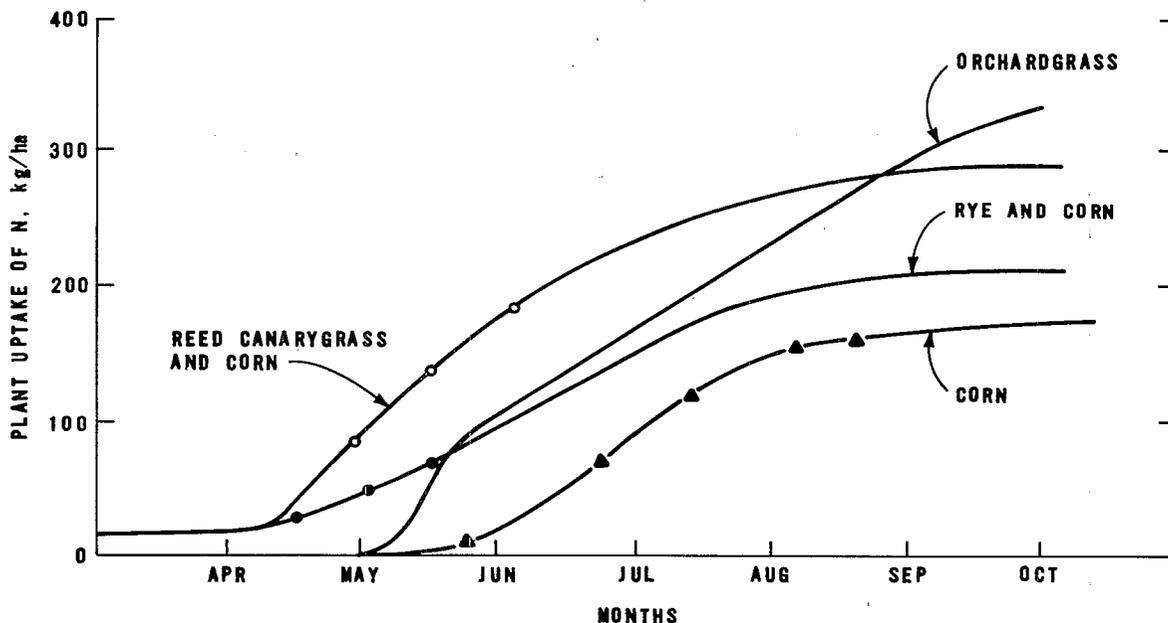

FIGURE 4-2
NITROGEN UPTAKE VERSUS GROWING DAYS
FOR ANNUAL AND PERENNIAL CROPS [20,21]

The micronutrients important to plant growth (in descending order) are: iron, manganese, zinc, boron, copper, molybdenum, and, occasionally, sodium, silicon, chloride, and cobalt. Most wastewaters contain an ample supply of these elements; in some cases, phytotoxicity may be a consideration.

Forest Crops

Vegetative uptake and storage of nutrients depend on the species and forest stand density, structure, age, length of season, and temperature. In addition to the trees, there is also nutrient uptake and storage by the understory tree and herbaceous vegetation. The role of the understory vegetation is particularly important in the early stages of tree establishment.

Forests take up and store nutrients and return a portion of those nutrients back to the soil in the form of leaf fall and other debris such as dead trees. Upon decomposition, the nutrients are released and the trees take them back up. During the initial stages of growth (1 to 2 years), tree seedlings are establishing a root system; biomass production and nutrient uptake are relatively slow. To prevent leaching of nitrogen to ground water during this period, nitrogen loading must be limited or understory vegetation must be established that will take up and store applied nitrogen that is in excess of the tree crop needs. Management of understory vegetation is discussed in Section 4.9.

Following the initial growth stage, the rates of growth and nutrient uptake increase and remain relatively constant until maturity is approached and the rates decrease. When growth rates and nutrient uptake rates begin to decrease, the stand should be harvested or the nutrient loading decreased. Maturity may be reached at 20 to 25 years for southern pines, 50 to 60 years for hardwoods, and 60 to 80 years for some of the western conifers such as Douglas-fir. Of course, harvesting may be practiced well in advance of maturity as with short-term rotation management (see Section 4.9.2.5).

Estimates of the net annual nitrogen storage for a number of fully stocked forest ecosystems are presented in Table 4-12. These estimates are maximum rates of net nitrogen uptake considering both the understory and overstory vegetation during the period of active tree growth.

TABLE 4-12
ESTIMATED NET ANNUAL NITROGEN UPTAKE IN THE
OVERSTORY AND UNDERSTORY VEGETATION OF FULLY
STOCKED AND VIGOROUSLY GROWING FOREST
ECOSYSTEMS IN SELECTED REGIONS OF THE UNITED STATES [22]

	Tree age, yr	Average annual nitrogen uptake, kg/ha·yr
<u>Eastern forests</u>		
Mixed hardwoods	40-60	220
Red pine	25	110
Old field with white spruce plantation	15	280
Pioneer succession	5-15	280
<u>Southern forests</u>		
Mixed hardwoods	40-60	340
Southern pine with no understory	20	220 ^a
Southern pine with understory	20	320
<u>Lake states forests</u>		
Mixed hardwoods	50	110
Hybrid poplar ^b	5	155
<u>Western forests</u>		
Hybrid poplar ^b	4-5	300-400
Douglas-fir plantation	15-25	150-250

a. Principal southern pine included in these estimates is loblolly pine.

b. Short-term rotation with harvesting at 4-5 yr; represents first growth cycle from planted seedlings (see Section 4.9.2.4).

Because nitrogen stored within the biomass of trees is not uniformly distributed among the tree components, the amount of nitrogen that can actually be removed with a forest crop system will be substantially less than the storage estimates given in Table 4-12 unless 100% of the aboveground biomass is harvested (whole-tree harvesting). If only the merchantable stems are removed from the system, the net amount of nitrogen removed by the system will be less than 30% of the amount stored in the biomass. The distributions of biomass and nitrogen for naturally growing hardwood and conifer (pines, Douglas-fir, fir, larch, etc.) stands in temperate regions are shown in Table 4-13. For deciduous species, whole-tree harvesting must take place in the summer when the leaves are on the trees if maximum nitrogen removal is to be achieved.

TABLE 4-13
BIOMASS AND NITROGEN DISTRIBUTIONS BY TREE
COMPONENT FOR STANDS IN TEMPERATE REGIONS [23]
Percent

Tree component	Conifers		Hardwoods	
	Biomass	Nitrogen	Biomass	Nitrogen
Roots	10	17	12	18
Stems	80	50	65	32
Branches	8	12	22	42
Leaves	2	20	1	8

The assimilative capacity for both phosphorus and trace metals is controlled more by soil properties than plant uptake. The relatively low pH (4.2 to 5.5) of most forest soils is favorable to the retention of phosphorus but not trace metals. However, the high level of organic matter in forest soil improves the metal removal capacity. The amount of phosphorus in trees is small, usually less than 30 kg/ha (27 lb/acre); therefore, the amount of annual phosphorus accumulation is quite small.

4.3.2.2 Moisture Tolerance

Crops that can be exposed to prolonged periods of high soil moisture without suffering damage or yield reduction are said to have a high moisture or water tolerance. This characteristic is desirable in situations (1) where hydraulic loading rates must be maximized, (2) where the root zone contains a slowly permeable soil, or (3) in humid areas where sufficient moisture already exists for plant growth. Refer to Table 4-8 for a comparison of crop moisture tolerances. Alfalfa and red pine, for example, have low moisture tolerances.

4.3.2.3 Consumptive Water Use

Consumptive water use by plants is also termed evapotranspiration (ET). Consumptive water use varies with the physical characteristics and the growth stage of the crop, the soil moisture level, and the local climate. In some states, estimates of maximum monthly consumptive water use for many crops can be obtained from local agricultural extension offices or research stations or the SCS. Where this information is not available, it will be necessary to make estimates of evapotranspiration using temperature and

other climatic data. Several methods of estimating evapotranspiration are available and are detailed in publications by the American Society of Civil Engineers (ASCE) [24], the Food and Agriculture Organization (FAO) of the United Nations [25], and the SCS [26].

Agricultural Crops

In humid regions estimates of potential evapotranspiration (PET) are usually sufficient for perennial, full-cover crops. Examples of estimated PET for humid and subhumid climates are shown in Table 4-14. Examples of monthly consumptive use in arid regions are shown in Table 4-15 for several California crops. These table values are specific for the location given and are intended to illustrate variation in ET due to crop and climate. The designer should obtain or estimate ET values that are specific to the site under design.

TABLE 4-14
EXAMPLES OF ESTIMATED MONTHLY POTENTIAL
EVAPOTRANSPIRATION FOR HUMID AND SUBHUMID CLIMATES
cm

Month	Paris, Texas	Central Missouri	Brevard, North Carolina	Jonesboro, Georgia	Hanover, New Hampshire	Seabrook, New Jersey
Jan	1.5	0.7	0.2	1.3	0.0	0.2
Feb	1.5	1.3	0.3	1.3	0.0	0.3
Mar	3.6	3.0	2.1	3.0	0.1	2.0
Apr	6.8	6.6	4.6	5.8	2.9	4.0
May	9.9	10.8	7.6	10.9	8.2	7.4
Jun	14.7	14.5	10.2	14.7	12.9	11.4
Jul	16.0	16.9	11.4	15.7	13.7	13.9
Aug	16.2	15.2	10.4	15.0	11.9	13.6
Sep	9.7	10.3	7.4	10.9	7.4	9.9
Oct	6.4	6.3	4.6	5.8	4.0	4.9
Nov	2.7	2.6	1.6	2.5	0.3	2.1
Dec	<u>1.4</u>	<u>1.1</u>	<u>0.3</u>	<u>1.3</u>	<u>0.0</u>	<u>0.3</u>
Annual	90.4	89.3	60.7	88.2	61.4	70.0

In arid or semiarid regions, water in excess of consumptive use must be applied to (1) ensure proper soil moisture conditions for seed germination, plant emergence, and root development; (2) flush salts from the root zone; and (3) account for nonuniformity of water application by the distribution system (see Section 4.7). This requirement is the irrigation requirement and examples are shown in Table 4-15. Local irrigation specialists should be consulted for specific values.

TABLE 4-15
 CONSUMPTIVE WATER USE AND IRRIGATION REQUIREMENTS FOR
 SELECTED CROPS AT SAN JOAQUIN VALLEY, CALIFORNIA^a [27, 28]
 Depth of Water in cm

Month	Pastures or alfalfa ^b		Double crop barley and grain sorghum ^c		Cotton ^d		Sugar beets ^e	
	Consumptive use	Irrigation requirements	Consumptive use	Irrigation requirements	Consumptive use	Irrigation requirements	Consumptive use	Irrigation requirements
Jan	2.3	3.0	2.5	--	--	--	--	--
Feb	5.1	6.9	5.1	--	--	38.1 ^f	--	--
Mar	9.7	13.0	9.7	15.2	--	--	--	12.7
Apr	13.2	17.8	13.2	15.2	1.5	--	2.5	22.9
May	17.8	23.9	6.6	--	3.0	--	6.4	12.7
Jun	21.8	29.2	--	25.4 ^g	9.1	12.7	12.7	22.9
Jul	23.9	32.0	11.4	17.8	18.3	30.5	17.8	19.1
Aug	22.1	29.7	20.3	30.1	21.3	30.5	20.3	11.4
Sep	14.7	19.8	15.2	22.9	15.2	--	--	--
Oct	10.9	14.7	7.6	--	6.4	--	--	--
Nov	5.1	6.9	--	--	--	--	--	15.2 ^g
Dec	2.5	3.3	2.5	25.4	--	--	--	--
Total	149.1	200.2	94.1	152.0	74.8	111.8	59.7	116.9

- a. Other crops having similar growing seasons and ground cover will have similar consumptive use.
- b. Estimated maximum consumptive use (evapotranspiration) of water by mature crops with nearly complete ground cover throughout the year.
- c. Barley planted in November-December, harvested in June. Grain sorghum planted June 20-July 10, harvested in November-December.
- d. Rooting depth of mature cotton: 1.8 m. Planting dates: March 15 to April 20. Harvest: October, November, and December.
- e. Rooting depth: 1.5 to 1.8 m. Planting date: January. Harvest: July 15 to September 10.
- f. Preirrigation should wet soil to 1.5 to 1.8 m depth prior to planting.
- g. Preirrigation is used to ensure germination and emergence. First crop irrigations are heavy in order to provide deep moisture.

Forest Crops

The consumptive water use of forest crops under high soil moisture conditions may exceed that of forage crops in the same area by as much as 30%. For design purposes, however, the potential ET is used because there is little information on water use of different forest species. The seasonal pattern of water use for conifers is more uniform than for deciduous trees.

4.3.2.4 Effect on Soil Hydraulic Properties

In general, plants tend to increase both the infiltration rate of the soil surface and the effective hydraulic conductivity of the soil in the root zone as a result of root penetration and addition of organic matter. The magnitude of this effect varies among different crops. Thus, the crop selected can affect the design application rate of sprinkler distribution systems, which is based on

the steady state infiltration rate of the soil surface. Steady state infiltration rate is equivalent to the saturated permeability of surface soil. Design sprinkler application rates can be increased by 50% over the permeability value for most full-cover crops and by 100% for mature (>4 years old), well-managed permanent pastures (see Appendix E). The design application rate (cm/h or in./h) should not be confused with hydraulic loading rate (cm/wk or cm/mo) which is based on the permeability of the most restrictive layer in the soil profile. This layer, in many cases, is below the root zone and is unaffected by the crop.

Forest surface soils are generally characterized by high infiltration capacities and high porosities due to the presence of high levels of organic matter. The infiltration rates of most forest surface soils exceed all but the most extreme rainfall intensities. Therefore, surface infiltration rate is not usually a limiting factor in establishing the design application rate for sprinkler distribution in forest systems.

In addition, the permeability of subsurface forest soil horizons is generally improved over that found under other vegetation systems because there is: (1) no tillage, (2) minimum compaction from vehicular traffic, (3) decomposition of deep penetrating roots, and (4) a well-developed structure due to the increased organic matter content and microbial activity. Where subfreezing temperatures are encountered, the forest floor serves to insulate the soil so that soil freezing, if it does occur, occurs slowly and does not penetrate deeply. Consequently, wastewater application can often continue through the winter at forest systems.

4.3.2.5 Crop Water Quality Requirements and Toxicity Concerns

Wastewaters may have constituents that: (1) are harmful to plants (phytotoxic), (2) reduce the quality of the crop for marketing, or (3) can be taken up by plants and result in a toxic concern in the food chain. Thus, the effect of wastewater constituents on the crop itself and the potential for toxicity to plant consumers must be considered during the crop selection process. Agricultural crops are of primary concern.

A summary of common wastewater constituents that can adversely affect certain crops either through a direct toxic effect or through degradation of crop quality is given in Table 4-16. Also indicated in the table are the constituent concentrations at which problems occur. These effects are discussed in further detail in Chapter 9.

TABLE 4-16
SUMMARY OF WASTEWATER CONSTITUENTS
HAVING POTENTIAL ADVERSE EFFECTS
ON CROPS [29]

Problem and related constituent	Constituent level			Crops affected
	No problem	Increasing problems	Severe problems	
Salinity (EC _w), mmho/cm	<0.75	0.75-3.0	>3.0	Crops in arid climates only (see Table 9-4)
Specific ion toxicity from root absorption				
Boron, mg/L	<0.5	0.5-2	2.0-10.0	Fruit and citrus trees - 0.5-1.0 mg/L; field crops - 1.0-2.0 mg/L; grasses - 2.0-10.0 mg/L
Sodium, adj-SAR ^a	<3	3.0-9.0	>9.0	Tree crops
Chloride, mg/L	<142	142-355	>355	Tree crops
Specific ion toxicity from foliar absorption				
Sodium, mg/L	<69	>69	--	Field and vegetable crops under sprinkler application
Chloride, mg/L	<106	>106	--	
Miscellaneous				
NH ₄ -N + NO ₃ -N, mg/L	<5	5-30	30	Sugarbeets, potatoes, cotton, grains
HCO ₃ , mg/L	<90	90-520	>520	Fruit
pH, units	6.5-8.4	4.2-5.5	<4.2 and >8.5	Most crops

a. Adjusted sodium adsorption ratio.

Trace elements, particularly zinc, copper, and nickel are of concern for phytotoxicity. However, the concentration of these elements in wastewaters is well below the toxic level of all crops and phytotoxicity could only occur as a result of long-term accumulation of these elements in the soil.

4.4 Preapplication Treatment

Preapplication treatment is provided for three reasons:

1. Protection of public health as it relates to human consumption of crops or crop byproducts or to direct exposure to applied wastewater
2. Prevention of nuisance conditions during storage
3. Prevention of operating problems in distribution systems

Preapplication treatment is not necessary for the SR process to achieve maximum treatment, except in the case of harmful

or toxic constituents from industrial sources (see Section 4.4.3). The SR process is capable of removing high levels of most constituents present in municipal wastewaters, and maximum use should be made of this renovative capacity in a complete treatment system. Therefore, the level of preapplication treatment provided should be the minimum necessary to achieve the three stated objectives. In general, any additional preapplication treatment will result in higher costs and energy use.

The EPA has issued general guidelines for assessing the level of preapplication treatment necessary for SR systems [30]. The guidelines are intended to provide adequate protection for public health:

- A. Primary treatment - acceptable for isolated locations with restricted public access and when limited to crops not for direct human consumption.
- B. Biological treatment by ponds or inplant processes plus control of fecal coliform count to less than 1,000 MPN/100 mL - acceptable for controlled agricultural irrigation except for human food crops to be eaten raw.
- C. Biological treatment by ponds or inplant processes with additional BOD or SS control as needed for aesthetics plus disinfection to log mean of 200/100 mL (EPA fecal coliform criteria for bathing waters) - acceptable for application in public access areas such as parks and golf courses.

In most cases, state or local public health or water quality control agencies regulate the quality of municipal wastewater that can be used for SR. The appropriate state and local agencies should be contacted early in the design process to determine specific restrictions on the quality of applied wastewater.

4.4.1 Preapplication Treatment for Storage and During Storage

Objectionable odors and nuisance conditions can occur if anaerobic conditions develop near the surface in a storage pond. Two preapplication treatment options are available to prevent odors:

1. Reduce the oxygen demand of the wastewater prior to storage.

2. Design the storage pond as a deep facultative pond, using appropriate BOD loading.

Complete biological treatment and disinfection are unnecessary prior to storage. The level of treatment provided should not exceed that necessary to control odors. For storage ponds with short detention times (less than 10 to 15 days), a reduction in the BOD of the wastewater to a range of 40 to 75 mg/L should be sufficient to prevent odors. An aerated cell is normally used for BOD reduction in such cases. For storage ponds with longer detention times, BOD reduction before storage is normally not required because the storage pond is serving as a stabilization pond.

Wastewater undergoes treatment during storage. Suspended solids, oxygen demand, nitrogen, and microorganisms are reduced. In general, the extent of reduction depends on the length of the storage period. In the case of nitrogen, removal during storage can affect the design and operation of the SR process because the allowable hydraulic loading rate may be governed by the nitrogen concentration of the applied wastewater. Nitrogen removal in storage reservoirs can be substantial and depends on several factors including detention time, temperature, pH, and pond depth. A preliminary model to estimate nitrogen removals in ponds during ice-free periods has been developed [31]:

$$N_t = N_o e^{-0.0075t} \quad (4-1)$$

where N_t = nitrogen concentration in pond effluent (total N), mg/L

N_o = nitrogen concentration entering pond (total N), mg/L

t = detention time, d

A more precise model for predicting ammonia nitrogen removals in ponds is presented in the Process Design Manual on Wastewater Treatment Ponds [32].

Nitrogen in pond effluent is predominantly in the ammonia or organic form. In most cases, it is desirable to apply nitrogen in these forms to SR systems because they are held at least temporarily in the soil profile and are available for plant uptake for longer periods than nitrate, which is mobile in the soil profile. Ammonia and organic nitrogen which is converted to ammonia, are particularly desirable in

forest systems because many tree species do not take up nitrate as efficiently as ammonia.

A model describing the removal of fecal coliforms in pond systems has also been developed [33]:

$$C_f = C_i e^{-Kt\theta^{(T-20)}} \quad (4-2)$$

where C_f = effluent fecal coliform concentration,
No./100 mL

C_i = entering fecal coliform concentration,
No./100 mL

K = 0.5 warm months;
0.03 cold months

t = "actual" detention time, d

θ = 1.072

T = liquid temperature, °C.

Based on this model, actual detention times of about 17 days and 21 days would be necessary at 20 °C (68 °F) to reduce the coliform level of a typical domestic wastewater to 1,000/100 mL and 200/100 mL, respectively. Thus, effluent from storage reservoirs, in many cases, may meet the EPA coliform recommendations for SR systems without disinfection.

Removal of viruses in ponds is also quite rapid at warm temperatures. Essentially complete removal of Coxsackie and polio viruses was observed after 20 days at 20 °C [34].

4.4.2 Preapplication Treatment to Protect Distribution Systems

Deposition of settleable solids and grease in distribution laterals or ditches can cause reduction in the flow capacity of the distribution network and odors at the point of application. Coarse solids can cause severe clogging problems in sprinkler distribution systems. Removal of settleable solids and oil and grease (i.e., primary sedimentation or equivalent) is therefore recommended as a minimum level of preapplication treatment. For sprinkler systems, it has been recommended that the size of the largest particle in the applied wastewater be less than one-

third the diameter of the sprinkler nozzle to avoid plugging.

4.4.3 Industrial Pretreatment

Pollutants that are compatible with conventional secondary treatment systems would generally be compatible with land treatment systems. As with conventional systems, pretreatment requirements will be necessary for such constituents as fats, grease and oils, and sulfides to protect collection systems and treatment components. Pretreatment requirements for conventional biological treatment will also be sufficient for land treatment processes.

4.5 Loading Rates and Land Area Requirements

The hydraulic loading rate is the volume of wastewater applied per unit area of land over at least one loading cycle. Hydraulic loading rate is commonly expressed in cm/wk or m/yr (in./wk or ft/yr) and is used to compute the land area required for the SR process. The hydraulic loading rate used for design is based on the more restrictive of two limiting conditions--the capacity of the soil profile to transmit water (soil permeability) or the nitrogen concentration in water percolating beyond the root zone.

A separate case is considered for those systems in arid regions where crop revenue is important and the wastewater is used as a valuable source of irrigation water. For such systems, the design hydraulic loading rate is usually based on the irrigation requirements of the crop.

4.5.1 Hydraulic Loading Rate Based on Soil Permeability

The general water balance equation with rates based on a monthly time period is the basis of this procedure. The equation, with runoff of applied water assumed to be zero, is:

$$L_w = ET - Pr + P_w \quad (4-3)$$

where L_w = wastewater hydraulic loading rate

ET = evapotranspiration rate

Pr = precipitation rate

P_w = percolation rate

The basic steps in the procedure are:

1. Determine the design precipitation for each month based on a 5 year return period frequency analysis for monthly precipitation. Alternatively, use a 10 year return period for annual precipitation and distribute it monthly based on the ratio of average monthly to average annual precipitation.
2. Estimate the monthly ET rate of the selected crop (see Section 4.3.2.3).
3. Determine by field test the minimum clear water permeability of the soil profile. If the minimum soil permeability is variable over the site, determine an average minimum permeability based on areas of different soil types.
4. Establish a maximum daily design percolation rate that does not exceed 4 to 10% of minimum soil permeability (see Figure 2-3). Percentages on the lower end of the scale are recommended for variable or poorly defined soil conditions. The percentage to use is a judgment decision to be made by the designer. The daily percolation rate is determined as follows:

$$P_w(\text{daily}) = \text{permeability, cm/h (24 h/d)(4 to 10\%)}$$

5. Calculate the monthly percolation rate with adjustments for those months having periods of nonoperation. Nonoperation may be due to:
 - Crop management. Downtime must be allowed for harvesting, planting, and cultivation as applicable.
 - Precipitation. Downtime for precipitation is already factored into the water balance computation. No adjustments are necessary.
 - Freezing temperatures. Subfreezing temperatures cause soil frost that reduces surface infiltration rate. Operation is usually stopped when this occurs. The most conservative approach to adjusting the monthly percolation rate for freezing conditions is to allow no operation for days during the month when the mean temperature is less than 0 °C (32 °F). A less conservative approach is to use a lower minimum temperature. The recommended lowest mean temperature for operation is -4 °C (25 °F). Data sources and procedures for determining the number of subfreezing days during a month are presented in Sections 2.2.1.3,

2.2.2.2, and 4.6. Nonoperating days due to freezing conditions may also be estimated using the EPA-1 computer program without precipitation constraints (see Section 4.6.2). For forest crops, operation can often continue during subfreezing conditions.

- Seasonal crops. When single annual crops are grown, wastewater is not normally applied during the winter season, although applications may occur after harvest and before the next planting. The design monthly percolation rate may be calculated as follows:

$$P_w(\text{monthly}) = [P_w(\text{daily})] \times (\text{No. of operating d/mo})$$

6. Calculate the monthly hydraulic loading rate using Equation 4-3. The monthly hydraulic loadings are summed to yield the allowable annual hydraulic loading rate based on soil permeability [$L_w(P)$]. The computation procedure is illustrated by an example for both arid and humid climates in Table 4-17. The example is based on systems growing permanent pasture and having similar winter weather and soil conditions. Downtime is allowed for freezing conditions, but pasture management does not require harvesting downtime.

The allowable hydraulic loading rate based on soil permeability calculated by the above procedure $L_w(P)$ is the maximum rate for a particular site and operating conditions, and this rate will be used for design if there are no other constraints or limitations. If other limitations exist, such as percolate nitrogen concentration, it is necessary to calculate the allowable hydraulic loading rate based on these limitations and compare that rate with the $L_w(P)$. The lower of the two rates is used for design.

4.5.2 Hydraulic Loading Rate Based on Nitrogen Limits

In municipal wastewaters applied to SR systems, nitrogen is usually the limiting constituent when protection of potable ground water aquifers is a concern. If percolating water from an SR system will enter a potable ground water aquifer, then the system should be designed such that the concentration of nitrate nitrogen in the receiving ground water at the project boundary does not exceed 10 mg/L.

TABLE 4-17
 WATER BALANCE TO DETERMINE HYDRAULIC LOADING
 RATES BASED ON SOIL PERMEABILITY
 cm

Month	(2) ET, Evapotrans- piration	(3) Pr, precip- itation	(4)=(2)-(3) Net ET	(5) P _w , Percolation ^a	(6)=(4)+(5) L _{w(p)} , wastewater hydraulic loading
<u>Arid climates</u>					
Jan	2.3	3.0	-0.7	5.1	4.4
Feb	5.1	2.8	2.3	12.6	14.9
Mar	9.7	2.8	6.9	16.3	23.2
Apr	13.2	2.0	11.2	18.0	29.2
May	17.7	0.5	17.2	18.0	35.2
Jun	21.8	0.3	21.5	18.0	39.5
Jul	23.9	--	23.9	18.0	41.9
Aug	22.1	--	22.1	18.0	40.2
Sep	14.7	0.3	14.4	18.0	32.4
Oct	10.9	0.8	10.1	18.0	28.1
Nov	5.1	1.3	3.8	17.0	20.8
Dec	2.5	2.5	0.0	14.1	14.1
Annual	149.0	16.3	132.7	191.1	323.8
<u>Humid climates</u>					
Jan	1.3	13.5	-12.2	5.1	0.0 ^b
Feb	1.3	13.0	-11.7	12.6	0.9
Mar	3.0	15.5	-12.5	16.3	3.8
Apr	5.8	11.3	- 5.5	18.0	12.5
May	10.9	11.1	- 0.2	18.0	17.8
Jun	14.7	11.7	3.0	18.0	21.0
Jul	15.7	13.3	2.4	18.0	20.4
Aug	15.0	11.1	3.9	18.0	21.9
Sep	10.9	9.1	1.8	18.0	19.8
Oct	5.8	8.0	- 2.2	18.0	15.8
Nov	2.5	8.0	- 5.5	17.0	11.5
Dec	1.3	12.8	-11.5	14.1	2.6
Annual	88.2	138.4	-50.2	191.1	148.0

a. Based on a soil profile with a moderately slow permeability (0.5 to 1.5 cm/h), P_w(max) = (0.5 cm/h) (24 h/d) (30 d/mo) (0.05) = 18.0

b. L_w cannot be less than zero.

The approach to meeting this requirement involves first estimating an allowable hydraulic loading rate based on an annual nitrogen balance (L_{w(n)}), and comparing that to the previously calculated L_{w(p)} to determine which value controls. The detailed steps in this procedure are:

1. Calculate the allowable annual hydraulic loading rate based on nitrogen limits using the following equation:

$$L_{w(n)} = \frac{(C_p)(Pr - ET) + (U)(10)}{(1-f)(C_n) - C_p} \quad (4-4)$$

where $L_w(n)$ = allowable annual hydraulic loading rate based on nitrogen limits, cm/yr

C_p = nitrogen concentration in percolating water, mg/L

Pr = precipitation rate, cm/yr

ET = evapotranspiration rate, cm/yr

U = nitrogen uptake by crop, kg/ha·yr (Tables 4-2, 4-11, 4-12)

C_n = nitrogen concentration in applied wastewater, mg/L (after losses in preapplication treatment)

f = fraction of applied nitrogen removed by denitrification and volatilization (4.2.2).

2. Compare the value of $L_w(n)$ with the value of $L_w(p)$ calculated previously (Section 4.5.1). If $L_w(n)$ is greater than $L_w(p)$, do not continue the procedure and use $L_w(p)$ for design. If $L_w(n)$ is less than or equal to $L_w(p)$, design should be based on $L_w(n)$. The value of $L_w(n)$ calculated in Step 1 above may be used to estimate land requirements for purposes of Phase 2 planning, but for final design the procedure outlined in Steps 3 and 4 should be used.
3. Calculate an allowable monthly hydraulic loading rate based on nitrogen limits using Equation 4-4 with monthly values for Pr , ET , and U . Monthly values for Pr and ET will have been determined previously for the water balance table (see Section 4.5.1). Monthly values for crop uptake (U) can be estimated by assuming that annual crop uptake is distributed monthly according to the same ratio as monthly to total growing season ET .

If data on nitrogen uptake versus time, such as that shown in Figure 4-2, are available for the crops and climatic region specific to the project under design, then such information may be used to develop a more accurate estimate of monthly nitrogen uptake values.

4. Compare each monthly value of $L_w(n)$ with the corresponding monthly value of $L_w(p)$ calculated previously (Section 4.5.1). The lower of the two

values should be used for design. The design monthly hydraulic loading rates are summed to yield the design annual hydraulic loading rate.

The above procedure is illustrated in Example 4-1 for an arid climate and a humid climate using the climatic and operating conditions given in Table 4-17.

EXAMPLE 4-1: CALCULATION TO ESTIMATE DESIGN HYDRAULIC LOADING RATE

Conditions

	<u>Humid climate</u>	<u>Arid climate</u>
1. Applied wastewater nitrogen concentration (C_N), mg/L	25	25
2. Crop nitrogen uptake (U), kg/ha·yr	336	336
3. Denitrification + volatilization (as a fraction of applied nitrogen)	0.2	0.2
4. Limiting percolate nitrogen concentration (C_p), mg/L	10	10
5. Precipitation (Pr) and evapotranspiration (ET) (see Table 4-17).		

Calculations

1. Calculate allowable annual $L_w(n)$ using Equation 4-4.

$$L_w(n) = \frac{(C_p)(Pr - ET) + (U)(10)}{(1 - f)(C_N) - C_p}$$

<u>Humid climate</u>	<u>Arid climate</u>
$L_w(n) = \frac{(10)(138.4 - 88.2) + (336)(10)}{(1 - 0.2)(25) - 10}$	$L_w(n) = \frac{(10)(16.3 - 149) + (336)(10)}{(1 - 0.2)(25) - 10}$
= 386.2 cm/yr	= 203.3 cm/yr

2. Compare $L_w(n)$ with $L_w(p)$.

<u>Humid climate</u>	<u>Arid climate</u>
$L_w(n) = 386.2$ cm/yr	$L_w(n) = 203.3$ cm/yr
$L_w(p) = 148.0$ cm/yr	$L_w(p) = 323.8$ cm/yr
∴ $L_w(p)$ controls. Use $L_w(p)$ for design (see Table 4-17)	∴ $L_w(n)$ controls. Continue to Step 3.

3. Compute allowable monthly $L_w(n)$ using Equation 4-4 and estimated monthly nitrogen uptake and monthly (Pr - ET) values. Compare with monthly $L_w(p)$ and use lower value for design. Tabulate results. (Arid climate only)

<u>Month</u>	<u>(Pr - ET), cm</u>	<u>(U), kg/ha</u>	<u>$L_w(n)$, cm</u>	<u>$L_w(p)$, cm</u>	<u>Design L_w, cm</u>
Jan	0.7	5.2	5.9	4.4	4.4
Feb	-2.3	11.5	9.2	17.5	9.2
Mar	-6.9	21.9	15.0	23.2	15.0
Apr	-11.2	29.8	18.6	29.2	18.6
May	-17.2	39.9	22.6	35.2	22.6
Jun	-21.5	49.2	27.6	39.5	27.6
Jul	-23.9	53.9	30.0	41.9	30.0
Aug	-22.1	49.8	27.9	40.2	27.9
Sep	-14.4	33.1	18.7	32.4	18.7
Oct	-10.1	24.6	14.5	28.1	14.5
Nov	-3.8	11.5	7.7	20.8	7.7
Dec	0.0	5.6	5.6	14.1	5.6
Annual	-132.7	336	203.3	323.8	201.8

The above procedure for calculating allowable hydraulic loading rate based on nitrogen limits is based on the following assumptions:

1. All percolate nitrogen is in the nitrate form.
2. No storage of nitrogen occurs in the soil profile.
3. No mixing and dilution of the percolate with in situ ground water occurs.

Use of these assumptions results in a very conservative estimate of percolate nitrogen. This procedure should ensure that the nitrogen concentration in the ground water at the project boundaries will be less than the specified value of C_p .

As indicated by the example, nitrogen loading is more likely to govern the design hydraulic loading rate for systems in arid climates than in humid climates. The reason for this is that the net positive ET rate in arid climates causes an increase in the concentration of the nitrogen level in the percolating water.

For systems in arid climates, it is possible that the design monthly hydraulic loading rates based on nitrogen limits will be less than the irrigation requirements (IR) of the crop. The designer should compare the design L_w with the irrigation requirement to determine if this situation exists. If it does exist, the designer has three options available to increase $L_{w(n)}$ sufficiently to meet the IR.

1. Reduce the concentration of applied nitrogen (C_n) through preapplication treatment.
2. Demonstrate that sufficient mixing and dilution (see Section 3.6.2) will occur with the existing ground water to permit higher values of percolate nitrogen concentration (C_p) to be used in Equation 4-4.
3. Select a different crop with a higher nitrogen uptake (U).

4.5.3 Hydraulic Loading Rate Based on Irrigation Requirements

For SR systems in arid regions that have crop production for revenue as the objective, the design hydraulic loading rate can be determined on the basis of the crop irrigation

requirement (see Section 4.3.2.1) using a modified water balance equation:

$$L_w = IR - Pr \quad (4-5)$$

where L_w = hydraulic loading rate

IR = crop irrigation requirement

Pr = precipitation

The annual hydraulic loading rate is determined by summing the monthly hydraulic loading rates computed using Equation 4-5. The computational procedure is similar to that outlined in Section 4.5.1.

The monthly hydraulic loading rate based on IR should be checked against the allowable rate based on nitrogen limits ($L_{w(n)}$) as discussed in Section 4.5.2.

4.5.4 Land Area Requirements

The land area to which wastewater is actually applied is termed a field. In addition to the field area, the total land area required for an SR system includes land for preapplication treatment facilities, administration and maintenance buildings, service roads, buffer zones, and storage reservoir. Field area requirements and buffer zone requirements are discussed in this section. Storage area requirements are discussed in Section 4.6 and area requirements for preapplication treatment facilities, buildings, and service roads are determined by standard engineering practice not included in this manual.

4.5.4.1 Field Area Requirements

The required field area is determined from the design hydraulic loading rate according to the following equation:

$$A_w = \frac{(Q)(365)(d/yr) + \Delta V_s}{C(L_w)} \quad (4-6)$$

where A_w = field area, ha (acre)

Q = average daily community wastewater flow (annual basis), m^3/d (ft^3/d)

ΔV_s = net loss or gain in stored wastewater volume due to precipitation, evaporation and seepage at storage pond, m^3/yr (ft^3/yr)

C = constant, 100 (3,630)

L_w = design hydraulic loading rate, cm/yr ($in./yr$)

The first calculation of field area must be made without considering net gain or loss from storage. After storage pond area is computed, the value of ΔV_s can be computed from precipitation and evaporation data. Field area then must be recalculated to account for ΔV_s .

Using the design hydraulic loading rate for the arid climate in Example 4-1, the field area for a daily wastewater flow of $1,000 m^3/d$, neglecting ΔV_s , is:

$$A_w = \frac{(1,000)(365)}{(10^4)(201.8)(0.01)} = 18.1 \text{ ha}$$

4.5.4.2 Buffer Zone Requirements

The objectives of buffer zones around land treatment sites are to control public access, and in some cases, improve project aesthetics. There are no universally accepted criteria for determining the width of buffer zones around SR treatment systems. In practice, the widths of buffer zones range from zero for remote systems to 60 m (200 ft) or more for systems using sprinklers near populated areas. In many states, the width of buffer zones is prescribed by regulatory agencies and the designer should determine if such requirements exist.

The requirements for buffer zones in forest systems are generally less than those of other vegetation systems because forests reduce wind speeds and, therefore, the potential movement of aerosols. Forests also provide a visual screen for the public. A minimum buffer zone width of 15 m (50 ft) that is managed as a multistoried forest canopy will be sufficient to meet all objectives. The multistoried effect is achieved by maintaining mature trees on the inside edge of the buffer next to the irrigated area and filling beneath the canopy and out to the outside edge of the buffer with trees that grow to a moderate height and have full, dense canopies. Evergreen species are the best selection if year-round operation is planned. If existing natural forests are used for the buffer, a minimum width of

15 m may be sufficient to meet the objectives, if there is an adequate vegetation density.

4.6 Storage Requirements

In almost all cases, SR systems require some storage for periods when the amount of available wastewater flow exceeds the design hydraulic loading rate. The approach used to determine storage requirements is to first estimate a storage volume requirement using a water balance computation or computer programs developed to estimate storage needs based on observed climatic variations throughout the United States. The final design volume then is determined by adjusting the estimated volume for net gain or loss due to precipitation and evaporation using a monthly water balance on the storage pond. These estimating and adjustment procedures are described in the following sections.

Some states prescribe a minimum storage volume (e.g., 10 days storage). The designer should determine if such storage requirements exist.

All applied wastewater does not need to pass through the storage reservoir. In cases where primary effluent is suitable for application, only the water that must be stored need receive prestorage treatment. Stored and fresh wastewater is then blended for application.

4.6.1 Estimation of Volume Requirements Using Storage Water Balance Calculations

An initial estimate of the storage volume requirements may be determined using a water balance calculation procedure. The basic steps in the procedure are illustrated using the arid climate example from Example 4-1:

1. Tabulate the design monthly hydraulic loading rate as indicated in Table 4-17.
2. Convert the actual volume of wastewater available each month to units of depth (cm) using the following relationship.

$$W_a = \frac{(Q_m)(10^{-2})}{A_w} \quad (4-7)$$

where W_a = depth of available wastewater, cm

Q_m = volume of available wastewater for the month, m^3

A_w = field area, ha

Insert the results for each month into a water balance table, as illustrated by the example in Table 4-18. In some communities, influent wastewater flow varies significantly with the time of year. The values used for Q_m should reflect monthly flow variation based on historical records. In this example, no monthly flow variation is assumed.

TABLE 4-18
ESTIMATION OF STORAGE VOLUME REQUIREMENTS
USING WATER BALANCE CALCULATIONS
cm

(1) Month	(2) L_w , wastewater hydraulic loading	(3) W_a , available wastewater ^a	(4) = $(3)-(2)$ Change in storage	(5) Cumulative storage
Oct	14.5	16.8	2.3	-0.2 ^b
Nov	7.7	16.8	9.1	2.3
Dec	5.6	16.8	11.2	11.4
Jan	4.4	16.8	12.4	22.6
Feb	9.2	16.8	7.6	35.0
Mar	15.0	16.8	1.8	42.6
Apr	18.6	16.8	- 1.8	44.4 ^c
May	22.6	16.8	- 5.8	42.6
Jun	27.6	16.8	-10.8	36.8
Jul	30.0	16.8	-13.2	26.0
Aug	27.9	16.8	-11.1	12.8
Sep	18.7	16.8	- 1.9	1.7
Annual	201.8	201.6		

a. Based on a field area of 18.1 ha and 30,438 m³/mo of wastewater.

b. Rounding error. Assume zero.

c. Maximum storage month.

3. Compute the net change in storage each month by subtracting the monthly hydraulic loading from the available wastewater in the same month.
4. Compute the cumulative storage at the end of each month by adding the change in storage during one month to the accumulated quantity from the previous month. The computation should begin with the reservoir empty at the beginning of the largest storage period. This month is usually October or November, but in some humid areas it may be February or March.

5. Compute the required storage volume using the maximum cumulative storage and the field area as indicated below.

$$\begin{aligned} &\text{Required storage volume} \\ &= (44.4 \text{ cm})(18.1 \text{ ha})(10^{-2} \text{ m/cm})(10^4 \text{ m}^2/\text{ha}) \\ &= 8.04 \times 10^4 \text{ m}^3 \end{aligned}$$

The advantage of using this water balance procedure to estimate storage volume requirements is that all factors that affect storage, including (1) seasonal changes in precipitation, evapotranspiration, and wastewater flow; and (2) downtime for precipitation or crop management are accounted for in the design hydraulic loading rate. The disadvantage of this procedure is that downtime for cold weather has to be determined separately and added in by reducing allowed monthly percolation.

4.6.2 Estimated Storage Volume Requirements Using Computer Programs

The National Climatic Center in Asheville, North Carolina, has conducted an extensive study of climatic variations throughout the United States and the effect of these variations on storage requirements for soil treatment systems [35]. Based on this study, three computer programs, as presented in Table 4-19, have been developed to estimate the storage days required when inclement weather conditions preclude land treatment system operation.

TABLE 4-19
SUMMARY OF COMPUTER PROGRAMS FOR DETERMINING
STORAGE FROM CLIMATIC VARIABLES [36]

EPA program	Applicability	Variables	Remarks
EPA-1	Cold climates	Mean temperature, rainfall, snow depth	Uses freeze index
EPA-2	Wet climates	Rainfall	Storage to avoid surface runoff
EPA-3	Moderate climates	Maximum and minimum temperature, rainfall, snow depth	Variation of EPA-1 for more temperate regions

Depending on the dominant climatic conditions of a region, one of the three computer programs will be most suitable. The program best suited to a particular region is shown in Figure 4-3. The storage days are calculated for recurrence intervals of 2, 4, 10, and 20 years. A list of stations

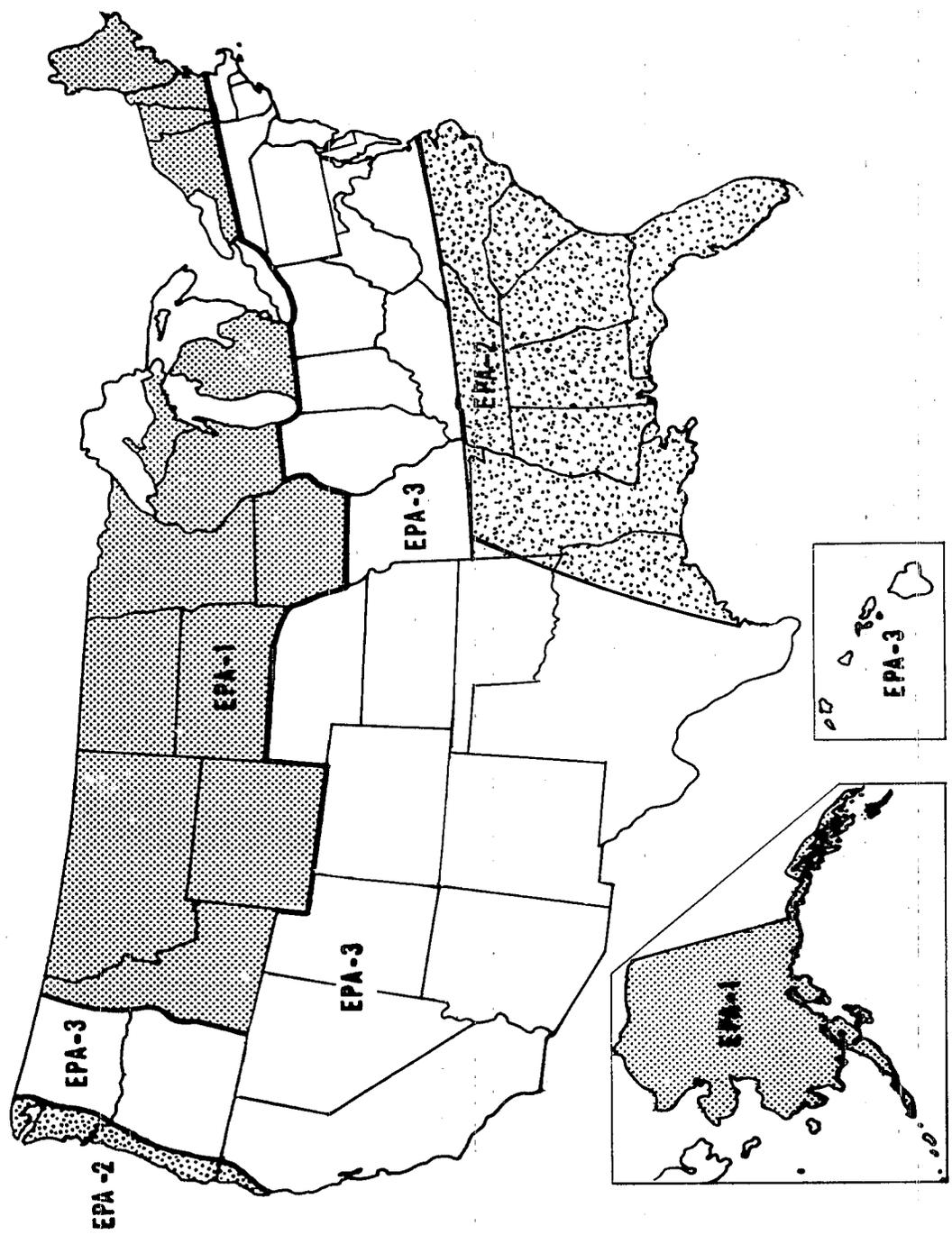

FIGURE 4-3
DETERMINATION OF STORAGE BY EPA COMPUTER PROGRAMS
ACCORDING TO CLIMATIC CONSTRAINTS

with storage days for 10 and 20 year recurrence intervals from EPA computer programs is presented in Appendix F. A list of 244 stations for which EPA-1 has been run is included in reference [35]. To use these programs, contact the National Climatic Center of the National Oceanic and Atmospheric Administration in Asheville, North Carolina 28801; a fee is required.

Storage days required for crop management activities (harvesting, planting, etc.) must be added to the computer estimated storage days due to weather to obtain the total storage days required in each month. The estimated required storage volume is then calculated by multiplying the estimated number of storage days in each month times the average daily flow for the corresponding month.

4.6.3 Final Design Storage Volume Calculations

The estimated storage volume requirement obtained by water balance calculation or computer programs must be adjusted to account for net gain or loss in volume due to precipitation or evaporation. The mass balance procedure is illustrated by Example 4-2 using arid climate data from Example 4-1 and the estimated storage volume from Table 4-18. An example for a system in a more humid climate is given in Appendix E.

EXAMPLE 4-2: CALCULATIONS TO DETERMINE FINAL STORAGE VOLUME REQUIREMENTS

1. Using the initial estimated storage volume and an assumed storage pond depth compatible with local conditions, calculate a required surface area for the storage pond:

$$A_S = \frac{V_S(\text{est})}{d_S} \quad (4-8)$$

where A_S = area of storage pond, m^2

$V_S(\text{est})$ = estimated storage volume, m^3

d_S = assumed pond depth, m

For the example, assume $d_S = 4$ m

$$\begin{aligned} A_S &= \frac{(8.02 \times 10^4 \text{ m}^3)}{4 \text{ m}} \\ &= 2 \times 10^4 \text{ m}^2 \end{aligned}$$

2. Calculate the monthly net volume of water gained or lost from storage due to precipitation, evaporation, and seepage:

$$\Delta V_S = (Pr - E - \text{seepage}) (A_S) (10^{-2} \text{ m/cm}) \quad (4-9)$$

where ΔV_S = net gain or loss in storage volume, m^3

Pr = design monthly precipitation, cm

E = monthly evaporation, cm

A_S = storage pond area

Estimated lake evaporation in the local area should be used for E , if available. Potential ET values may be used if no other data are available. Tabulate monthly values and sum to determine the net annual ΔV_S .

For example, assume:

$$\begin{aligned} E &= ET \\ \text{Seepage} &= 0 \end{aligned}$$

Results are tabulated in Column (2) of Table 4-20.

TABLE 4-20
FINAL STORAGE VOLUME REQUIREMENT CALCULATIONS
m³ x 10³

Month	(2) ΔVs Net gain/loss	(3) Q _m Available wastewater	(4) V _w Applied wastewater	(5) = (2) + (3) - (4) ΔVs Change in storage	Cumulative storage
Oct	-2.0	30.4	24.3	4.1	-0.2 ^a
Nov	-0.7	30.4	12.9	16.8	4.1
Dec	0.0	30.4	9.4	21.0	20.9
Jan	0.1	30.4	7.4	23.1	41.9
Feb	-0.5	30.4	15.4	14.5	65.0
Mar	-1.4	30.4	25.2	3.8	79.5
Apr	-2.2	30.4	31.2	-3.0	83.3 ^b
May	-3.4	30.4	37.9	-10.9	80.3
Jun	-4.3	30.4	46.3	-20.2	69.4
Jul	-4.8	30.4	50.3	-24.7	49.2
Aug	-4.4	30.4	46.8	-20.8	24.5
Sep	-2.9	30.4	31.4	-3.9	3.7
Annual	-26.5	365	338.5		

a. Rounding error (assume zero).

b. Maximum design storage volume.

3. Tabulate the volume of wastewater available each month (Q_m) accounting for any expected monthly flow variations. For the example, monthly flow is constant.

$$Q_m = \frac{(1,000 \text{ m}^3/\text{d})(365 \text{ d/yr})}{12 \text{ mo/yr}}$$

$$= 30.4 \times 10^3 \text{ m}^3/\text{mo}$$

4. Calculate an adjusted field area to account for annual net gain/loss in storage volume.

$$A_w' = \frac{\Sigma \Delta V_s + \Sigma Q_m}{(L_w)(10^4 \text{ m}^2/\text{ha})(10^{-2} \text{ m/cm})} \quad (4-10)$$

where A_w' = adjusted field area, ha

ΣΔV_s = annual net storage gain/loss, m³

ΣQ_m = annual available wastewater, m³

L_w = design annual hydraulic loading rate, cm

For the example:

$$A_w' = \frac{365 \times 10^3 - 26.5 \times 10^3}{(201.8)(10^4)(10^{-2})}$$

$$= 16.8 \text{ ha}$$

Note: The final design calculation reduced the field area from 18.1 ha to 16.8 ha.

5. Calculate the monthly volume of applied wastewater using the design monthly hydraulic loading rate and adjusted field area:

$$V_w = (L_w)(A_w')(10^4 \text{ m}^2/\text{ha})(10^{-2} \text{ m/cm}) \quad (4-11)$$

where V_w = monthly volume of applied wastewater, m³

L_w = design monthly hydraulic loading rate, cm

A_w' = adjusted field area, ha

Results are tabulated in Column (4) of Table 4-20.

6. Calculate the net change in storage each month by subtracting the monthly applied wastewater (V_w) from the sum of available wastewater (Q_m) and net storage gain/loss (ΔV_s) in the same month. Results are tabulated in Column (5) of Table 4-20.
7. Calculate the cumulative storage volume at the end of each month by adding the change in storage during one month to the accumulated total from the previous month. The computation should begin with the cumulative storage equal to zero at the beginning of the largest storage period. The maximum monthly cumulative volume is the storage volume requirement used for design. Results are tabulated in Column (6) of Table 4-20.

$$\text{Design } V_s = 83.3 \times 10^3 \text{ m}^3$$

8. Adjust the assumed value of storage pond depth (d_s) to yield the required design storage volume using Equation 4-12.

$$d_s = V_s/A_s \quad (4-12)$$

For the example

$$\begin{aligned} d_s &= \frac{83.3 \times 10^3 \text{ m}^3}{2 \times 10^4 \text{ m}^2} \\ &= 4.16 \text{ m} \end{aligned}$$

If the pond depth cannot be adjusted due to subsurface constraints, then the surface area must be adjusted to obtain the required design volume. However, if the surface area is changed, another iteration of the above procedure will be necessary because the value of net storage gain/loss (ΔV_s) will be different for a new pond area.

4.6.4 Storage Pond Design Considerations

Most agricultural storage ponds are constructed of homogeneous earth embankments, the design of which conforms to the principles of small dam design. Depending on the magnitude of the project, state regulations may govern the design. In California, for example, any reservoir with embankments higher than 1.8 m (6 ft) and a capacity in excess of 61,800 m³ (50 acre-ft) is subject to state regulations on design and construction of dams, and plans must be reviewed and approved by the appropriate agency. Design criteria and information sources are included in the U.S. Bureau of Reclamation publication, Design of Small Dams [37]. In many cases, it will be necessary that a competent soils engineer be consulted for proper soils analyses and structural design of foundations and embankments.

In addition to storage volume, the principal design parameters are depth and area. The design depth and area depend on the function of the pond and the topography at the pond site. If the storage pond is to also serve as a facultative pond, then a minimum water depth of at least 0.5 to 1 m (1.5 to 3 ft) should be maintained in the pond when the stored volume is at a minimum. The area must also be sufficient to meet the BOD pond loading criteria for the local climate. The use of aerators can reduce area requirements. The maximum depth depends on whether the reservoir is constructed with dikes or embankments on level ground or is constructed by damming a natural water course or ravine. Maximum depths of diked ponds typically range from 3 to 6 m (9 to 18 ft). Other design considerations include wind fetch, and the need for riprap and lining. These aspects of design are covered in standard engineering references and assistance is also available from local SCS offices.

4.7 Distribution System

Design of the distribution system involves two steps: (1) selection of the type of distribution system, and (2) detailed design of system components. Emphasis in this section is placed on criteria for selection of the type of distribution system. Design procedures for SR distribution systems are presented in Appendix E. Only basic design principles for each type of distribution system are presented in the manual, and the designer is referred to several standard agricultural engineering references for further design details. Certain design requirements of distribution systems for forest crop systems do not conform to standard agricultural irrigation practice and are discussed under a separate heading.

4.7.1 Surface Distribution Systems

With surface distribution systems, water is applied to the ground surface at one end of a field and allowed to spread over the field by gravity. Conditions favoring the selection of a surface distribution system include the following:

1. Capital is not available for the initial investment required for more sophisticated systems.
2. Skilled labor is available at reasonable rates to operate a surface system.
3. Surface topography of land requires little additional preparation to make uniform grades for surface distribution.

The principal limitations or disadvantages of surface systems include the following:

1. Land leveling costs may be excessive on uneven terrain.
2. Uniform distribution cannot be achieved with highly permeable soils.
3. Runoff control and a return system must be provided when applying wastewater.
4. Skilled labor is usually required to achieve proper performance.
5. Periodic maintenance of leveled surface is required to maintain uniform grades.

Surface distribution systems may be classified into two general types: ridge and furrow and graded border (also termed bermed cell). The distinguishing physical features of these methods are illustrated in Figure 4-4. A summary of variations of the basic surface methods and conditions for their use is presented in Table 4-21. Details of preliminary design are presented in Appendix E.

4.7.2 Sprinkler Distribution Systems

Sprinkler distribution systems simulate rainfall by creating a rotating jet of water that breaks up into small droplets that fall to the field surface. The advantages and disadvantages of sprinkler distribution systems relative to surface distribution systems are summarized in Table 4-22.

4.7.2.1 Types of Sprinkler Systems

In this manual, sprinkler systems are classified according to their movement during and between applications because this characteristic determines the procedure for design. There are three major categories of sprinkler systems based on movement: (1) solid set, (2) move-stop, and (3) continuous move. A summary of the various types of sprinkler systems under each category is given in Table 4-23 along with respective operating characteristics.

4.7.2.2 Sprinkler Distribution Systems for Forest

The requirements of distribution systems for forests are somewhat different from those for agricultural and turf crops.

Solid-set irrigation systems are the most commonly used systems in forests. Buried systems are less susceptible to damage from ice and snow and do not interfere with forest management activities (thinning, harvesting, and regeneration). A center pivot irrigation system has been used in Michigan for irrigation of Christmas trees because their growth height would not exceed the height of the pivot arms. Traveling guns have also been used to irrigate short-term rotation hardwood plantations.

As discussed in Section 4.3.2.4, the design sprinkler application rate is usually not limited by the infiltration capacity of most forest soils. Steep grades (up to 35%), in general, do not limit the design hydraulic loading rate per application for forest systems. In fact, hydraulic loadings per application may be increased up to 10% on grades greater than 15% because of the higher drainage rate. Precautions must be taken to make sure that water draining through the surface soil does not appear as runoff further down the slope.

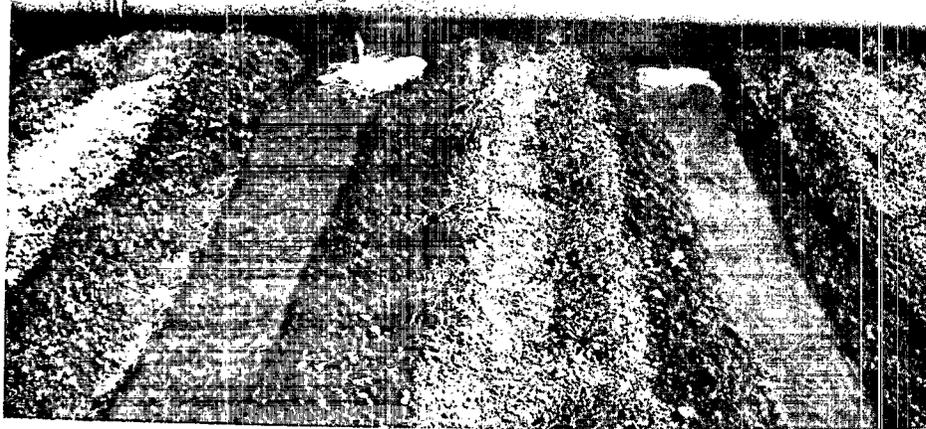

(a) RIDGE AND FURROW METHOD
USING GATED PIPE

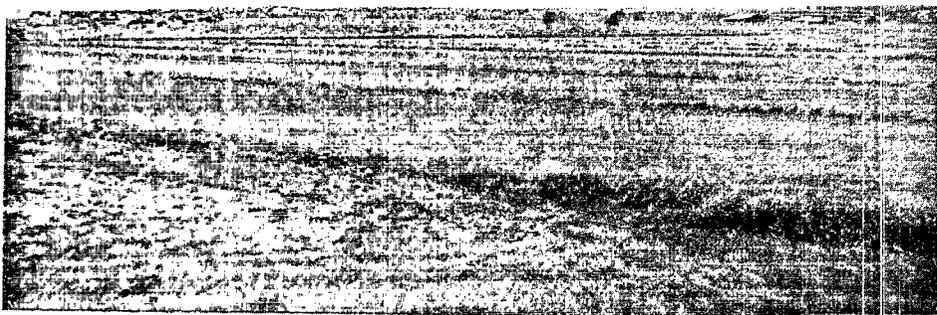

(b) GRADED BORDER METHOD

FIGURE 4-4
SURFACE DISTRIBUTION METHODS

TABLE 4-21
SURFACE DISTRIBUTION METHODS AND
CONDITIONS OF USE [38]

Suitabilities and conditions of use					
Distribution	Crops	Topography	Water quantity	Soils	Remarks
<u>Ridge and furrow</u>					
Straight furrows	Vegetables, row crops, orchards, vineyards	Uniform grades not exceeding 2% for cultivated crops	Flows up to 0.34 m ³ /s	Can be used on all soils if length of furrows is adjusted to type of soil	Best suited for crops that cannot be flooded. High irrigation efficiency possible. Well adapted to mechanized farming.
Graded contour furrows	Vegetables, field crops, orchards, vineyards	Undulating land with slopes up to 8%	Flows up to 0.08 m ³ /s	Soils of medium to fine texture that do not crack on drying	Rodent control is essential. Erosion hazard from heavy rains or water breaking out of furrows. High labor requirement for irrigation.
Corrugations	Close-spaced crops such as grain, pasture, alfalfa	Uniform grades of up to 10%	Flows up to 0.03 m ³ /s	Best on soils of medium to fine texture	High water losses possible from deep percolation or surface runoff. Care must be used in limiting size of flow in corrugations to reduce soil erosion. Little land grading required.
Basin furrows	Vegetables, cotton, maize, and other row crops	Relatively flat land	Flows up to 0.14 m ³ /s	Can be used with most soil types	Similar to small rectangular basins, except crops are planted on ridges.
Zigzag furrows	Vineyards, bush berries, orchards	Uniform grades of less than 1%	Flows required are usually less than for straight furrows	Used on soils with low intake rates	This method is used to slow the flow of water in furrows to increase water penetration into soil.
<u>Graded border</u>					
Small rectangular basins	Grain, field crops, orchards, rice	Relatively flat land; area within each basin should be leveled	Can be adapted to streams of various sizes	Suitable for soils of high or low intake rates; should not be used on soils that tend to puddle	High installation costs. Considerable labor required for irrigating. When used for close-spaced crops, a high percentage of land is used for levees and distribution ditches. High efficiencies of water use possible.

Table 4-21 (Concluded)

Suitabilities and conditions of use					
Distribution	Crops	Topography	Water quantity	Soils	Remarks
Large rectangular basins	Grain, field crops, rice	Flat land; must be graded to uniform plane	Large flows of water	Soils of fine texture with low intake rates	Lower installation costs and less labor required for irrigation than small basins. Substantial levees needed.
Contour checks	Orchards, grain, rice, forage crops	Irregular land, grades less than 2%	Flows greater than 0.03 m ³ /s	Soils of medium to heavy texture that do not crack on drying	Little land grading required. Checks can be continuously flooded (rice), water ponded (orchards), or intermittently flooded (pastures).
Narrow borders up to 5 m wide	Pasture, grain, alfalfa, vineyards, orchards	Uniform grades less than 7%	Moderately large flows	Soils of medium to heavy texture	Borders should be in direction of maximum slope. Accurate cross-leveling required between guide levees.
Wide borders up to 30 m wide	Grain, alfalfa, orchards	Uniform grades less than 0.3%	Large flows, up to 0.56 m ³ /s	Deep soils of medium to fine texture	Very careful land grading necessary. Minimum of labor required for irrigation. Little interference with use of farm machinery.
Benched terraces	Grain, field crops,	Grades up to 20%	Streams of small to medium size	Soils must be sufficiently deep that grading operations will not impair crop growth	Care must be taken in constructing benches and providing adequate drainage channel for excess water. Irrigation water must be properly managed. Misuse of water can result in serious soil erosion.

TABLE 4-22
ADVANTAGES AND DISADVANTAGES OF SPRINKLER
DISTRIBUTION SYSTEMS RELATIVE TO SURFACE
DISTRIBUTION SYSTEMS

Advantages	Disadvantages
1. Can be used on porous and variable soils.	1. Initial capital cost can be high.
2. Can be used on shallow soil profiles.	2. Energy costs are higher than for surface systems.
3. Can be used on rolling terrain.	3. Higher humidity levels can increase disease potential, for some crops.
4. Can be used on easily eroded soils.	4. Sprinkler application of high salinity water can cause leaf burn.
5. Can be used with small flows.	5. Water droplets can cause blossom damage to fruit crops or reduce the quality of some fruit and vegetable crops.
6. Skilled labor not required.	6. Portable or moving systems can get stuck in some clay soils.
7. Can be used where high water tables exist.	7. Higher levels of preapplication treatment generally are required for sprinkler systems than for surface systems to prevent operating problems (clogging).
8. Can be used for light, frequent applications.	8. Distribution is subject to wind distortion.
9. Control and measurement of applied water is easier.	9. Wind drift of sprays increases the potential for public exposure to wastewater.
10. Interference with cultivation is minimized.	
11. Higher application efficiencies are usually possible.	
12. Tailwater control and reapplication not usually required.	

TABLE 4-23
SPRINKLER SYSTEM CHARACTERISTICS

	Typical application rate, cm/h	Labor required per application, h/ha	Nozzle pressure range, N/cm ²	Size of single system, ha	Shape of field	Maximum grade, %	Maximum crop height, m
<u>Solid set</u>							
Permanent	0.13-5.08	0.02-0.04	21-69	Unlimited	Any shape	--	--
Portable	0.13-5.08	0.08-0.10	21-41	Unlimited	Any shape	--	--
<u>Move-stop</u>							
Hand move	0.03-5.08	0.2-0.6	21-41	<1-16	Any shape	20	--
End tow	0.03-5.08	0.08-0.16	21-41	8-16	Rectangular	5-10	--
Side wheel roll	0.25-5.08	0.04-0.12	21-41	8-32	Rectangular	5-10	1-1.2
Stationary gun	0.64-5.08	0.08-0.16	35-69	8-16	Any shape	20	--
<u>Continuous move</u>							
Traveling gun	0.64-2.54	0.04-0.12	35-69	16-41	Any shape	--	--
Center pivot	0.51-2.54	0.02-0.06	10-41	16-65	Circular ^a	5-15	2.4-3
Linear move	0.51-2.54	0.02-0.06	10-41	16-130	Rectangular	5-15	2.4-3

a. Travelers are available to allow irrigation of any shape field.

Solid set sprinkler systems for forest crops have some special design requirements. Spacing of sprinkler heads must be closer and operating pressures lower in forests than other vegetation systems because of the interference from tree trunks and leaves and possible damage to bark. An 18 m (60 ft) spacing between sprinklers and a 24 m (80 ft) spacing between laterals has proven to be an acceptable spacing for forested areas [39]. This spacing, with sprinkler overlap, provides good wastewater distribution at a reasonable cost. Operating pressures at the nozzle should not exceed 38 N/cm^2 (55 lb/in.^2), although pressures up to 59 N/cm^2 (85 lb/in.^2) may be used with mature or thick-barked hardwood species. The sprinkler risers should be high enough to raise the sprinkler above most of the understory vegetation, but generally not exceeding 1.5 m (5 ft). Low-trajectory sprinklers should be used so that water is not thrown into the tree canopies, particularly in the winter when ice buildup on pines and other evergreen trees can cause the trees to be broken or uprooted.

A number of different methods of applying wastewater during subfreezing temperatures in the winter have been attempted. These range from various modifications of rotating and nonrotating sprinklers to furrow and subterranean applications. General practice is to use low-trajectory, single nozzle impact-type sprinklers, or low trajectory, double nozzle hydraulic driven sprinklers. A spray nozzle used at West Dover, Vermont, is shown in Figure 4-5.

Installation of a buried solid-set irrigation system in existing forests must be done with care to avoid excessive damage to the trees or soil. Alternatively, solid-set systems can be placed on the surface if adequate line drainage is provided (see Figure 4-6). For buried systems, sufficient vegetation must be removed during construction to ensure ease of installation while minimizing site disturbance so that site productivity is not decreased or erosion hazard increased. A 3 m wide (10 ft) path cleared for each lateral meets these objectives. Following construction, the disturbed area must be mulched or seeded to restore infiltration and prevent erosion. During operation of the land treatment system, a 1.5 m (5 ft) radius should be kept clear around each sprinkler. This practice allows better distribution and more convenient observation of sprinkler operation. Spray distribution patterns will still not meet agricultural standards, but this is not as important in forests because the roots are quite extensive.

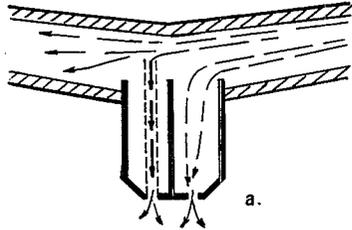

a. SPRAYING

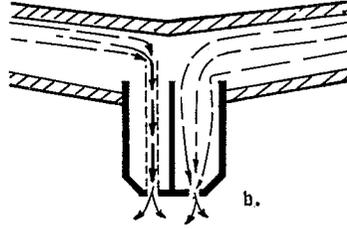

b. DRAINING

BRASS TUBE IN LEFT HALF DRAINS QUICKLY, UNTIL LIQUID LEVEL IS BELOW ITS TOP. THEN ONLY RIGHT HALF CONTINUES TO DRAIN.

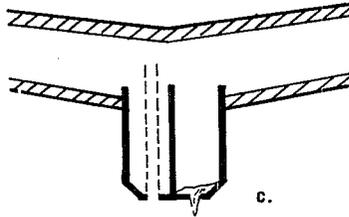

c. LINE DRAINED

SMALL AMOUNT OF ICE HAS FORMED TO BLOCK RIGHT HALF OF NOZZLE. BRASS TUBE LEFT HALF IS OPEN AND READY FOR NEXT SPRAY CYCLE.

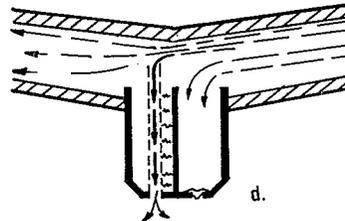

d. NEXT SPRAY CYCLE

WATER INITIALLY SPRAYS THROUGH THE BRASS TUBE ON THE LEFT SIDE. THE HEAT FROM THE LIQUID MELTS THE ICE PLUG BLOCKING THE RIGHT HALF OF THE NOZZLE AND SPRAYING RESUMES IN THE NORMAL MANNER AS SHOWN IN a.

FIGURE 4-5
FAN NOZZLE USED FOR SPRAY APPLICATION AT WEST DOVER, VERMONT



FIGURE 4-6
SOLID SET SPRINKLERS WITH
SURFACE PIPE IN A FOREST SYSTEM

4.7.3 Service Life of Distribution System Components

The expected service life of the distribution system components is a design consideration and must be used to develop detailed cost comparison. The suggested service lives of common distribution system components are listed in Table 4-24.

4.8 Drainage and Runoff Control

Provisions to improve or control subsurface drainage are sometimes necessary with SR systems to remove excess water from the root zone or to remove salts from the root zone when these conditions adversely affect crop growth. Control of surface runoff is necessary for SR systems using surface distribution methods. In humid areas with intense rainfalls, control of surface drainage is necessary to prevent erosion and may be helpful in reducing the amount of water entering the soil profile and thereby reducing or eliminating the need for subsurface drainage. Design considerations for drainage and runoff control provisions are discussed in the following sections.

4.8.1 Subsurface Drainage Systems

Subsurface drainage systems are used in situations where the natural rate of subsurface drainage is restricted by relatively impermeable layers in the soil profile near the surface or by high ground water. As a result of the restrictive layer, shallow ground water tables can form that extend into the root zone and even to the soil surface.

The major consideration for wastewater treatment is the maintenance of an aerobic zone in the upper soil profile. Many of the wastewater removal mechanisms require an aerobic environment to function most effectively. A travel distance of 0.6 to 1 m (2 to 3 ft) through aerobic soil is considered the minimum distance to achieve treatment by the SR process. Therefore, a water table depth of 1 m (3 ft) or more is desirable from a wastewater treatment standpoint.

TABLE 4-24
SUGGESTED SERVICE LIFE FOR COMPONENTS OF
DISTRIBUTION SYSTEM [40]

	Service life ^a	
	Hours ^b	years
Well and casing	--	20
Pump plant housing	--	20
Pump, turbine		
Bowl (about 50% of cost of pump unit)	16,000	8
Column, etc.	32,000	16
Pump, centrifugal	32,000	16
Power transmission		
Gear head	30,000	15
V-belt	6,000	3
Flat belt, rubber and fabric	10,000	5
Flat belt, leather	20,000	10
Power units		
Electric motor	50,000	25
Diesel engine	28,000	14
Gasoline or distillate		
Air cooled	8,000	4
Water cooled	18,000	9
Propane engine	28,000	14
Open farm ditches (permanent)	--	20
Concrete structures	--	20
Concrete pipe systems	--	20
Wood flumes	--	8
Pipe, surface, gated	--	10
Pipe, water works class	--	40
Pipe, steel, coated, underground	--	20
Pipe, aluminum, sprinkler use	--	15
Pipe, steel, coated, surface use only	--	10
Pipe, steel galvanized, surface only	--	15
Pipe, wood buried	--	20
Sprinkler heads	--	8
Solid set sprinkler system	--	20
Center pivot sprinkler system	--	10-14
Side roll traveling system	--	15-20
Traveling gun sprinkler system	--	10
Traveling gun hose system	--	4
Land grading ^c	--	None
Reservoirs ^d	--	None

- a. Certain irrigation equipment may have a shorter life when used in a wastewater treatment system.
- b. These hours may be used for year-round operation. The comparable period in years was based on a seasonal use of 2,000 h/yr.
- c. Some sources depreciate land leveling in 7 to 15 years. However, if proper annual maintenance is practiced, figure only interest on the leveling costs. Use interest on capital invested in water right purchase.
- d. Except where silting from watershed above will fill reservoir in an estimated period of years.

For SR systems where wastewater treatment and maximum hydraulic loading rate are the design objectives, the presence of excess moisture in the root zone is of limited concern for crops because water tolerant crops are generally selected for such systems. However, restrictive subsurface layers and resulting high water tables limit the allowable percolation rate and, therefore, the design hydraulic loading rate. Subsurface drains placed above the restrictive layer eliminate the effect of that layer on percolation and allow the design percolation rate to be based on more permeable overlying soil horizons. The design hydraulic loading rate is thereby increased.

In arid regions, the additional problem of salinity control is encountered. With such systems, excess water is applied to remove salts that concentrate in the root zone (Section 4.3.2.3). Where the natural drainage rate is insufficient to remove salty leaching water from the root zone within 2 to 3 days, crop damage due to salinity may occur depending on the tolerance of the crop and the salinity of the applied water (see Section 4.3.2.5). In such cases, the objectives of a subsurface drainage system are to (1) prevent the persistence of high water tables when leaching is practiced, and (2) to keep the water table sufficiently low between growing seasons to minimize evaporation from the water table and resulting salt accumulation in the root zone. As a rule of thumb, the water table should not be permitted to come closer than about 125 cm (49 in.) from the surface to prevent salt accumulation. This minimum depth is greater than those generally used in humid areas. Any drainage water from crop revenue systems that is discharged to surface waters must meet applicable discharge requirements.

The decision to use subsurface drains must be based on the economic benefit to be gained from their use. For example, the cost of installing and maintaining a subsurface drain system should be compared to the value of developing an otherwise unsuitable site or to the cost of a larger land area that will be required if subsurface drains are not used.

Buried plastic, concrete, and clay tile lines are normally used for underdrains. The choice usually depends on price and availability of materials. Where sulfates are present in the ground water, it is necessary to use a sulfate-resistant cement, if concrete pipe is chosen, to prevent excess internal stress from crystal formation. Most tile drains are mechanically laid in a machine dug trench or by direct plowing. Open trenches can be used for subsurface drainage, but if closely spaced, they can interfere with farming operations and consume usable land.

Underdrains are normally buried 1.8 to 2.4 m (6 to 8 ft) deep but can be as deep as 3 m (10 ft) or as shallow as 1 m (3 ft). Drains are normally 10 to 15 cm (4 to 6 in.) in diameter. Spacings as small as 15 to 30 m (50 to 100 ft) may be required for clayey soils. For sandy soils, 120 m (400 ft) is typical with the range being from 60 to 300 m (200 to 1,000 ft).

Procedures for determining the proper depth and spacing of drain lines to maintain the water table below a minimum depth are discussed in Section 5.7. Additional detailed design procedures and engineering aspects of subsurface drainage systems are described in references [41, 42, 43].

4.8.2 Surface Drainage and Runoff Control

Drainage and control of surface runoff is a design consideration for SR systems as it relates to tailwater from surface distribution systems and stormwater runoff from all systems.

4.8.2.1 Tailwater Return Systems

Most surface distribution systems will produce some runoff, which is referred to as tailwater. When partially treated wastewater is applied, tailwater must be contained within the treatment site and reapplied. Thus a tailwater return system is an integral part of an SR system using surface distribution methods. A typical tailwater return system consists of a sump or reservoir, a pump(s), and return pipeline.

The simplest and most flexible type of system is a storage reservoir system in which all or a portion of the tailwater flow from a given application is stored and either transferred to a main reservoir for later reapplication or reapplied from the tailwater reservoir to other portions of the field. Tailwater return systems should be designed to distribute collected water to all parts of the field, not consistently to the same area. If all the tailwater is stored, pumping can be continuous and can commence at the convenience of the operator. Pumps can be any convenient size, but a minimum capacity of 25% of the distribution system capacity is recommended [44]. If a portion of the tailwater flow is stored, the reservoir capacity can be reduced but pumping must begin during tailwater collection.

Cycling pump systems and continuous pumping systems can be designed to minimize the storage volume requirements, but these systems are much less flexible than storage systems. The designer is directed to reference [44] for design procedures.

The principal design variables for tailwater return systems are the volume of tailwater and the duration of tailwater flow. The expected values of these parameters for a well-operated system depend on the infiltration rate of the soil. Guidelines for estimating tailwater volume, the duration of tailwater flow, and suggested maximum design tailwater volume are presented in Table 4-25.

TABLE 4-25
RECOMMENDED DESIGN FACTORS
FOR TAILWATER RETURN SYSTEMS [44]

Permeability		Texture range	Maximum duration of tailwater flow, % of application time	Estimated tailwater volume, % of application volume	Suggested maximum design tailwater volume, % of application volume
Class	Rate, cm/h				
Very slow to slow	0.15-0.5	Clay to clay loam	33	15	30
Slow to moderate	0.5-1.5	Clay loam to silt loam	33	25	50
Moderate to moderately rapid	1.5-15	Silt loams to sandy loams	75	35	70

Runoff of applied wastewater from sites with sprinkler distribution systems should not occur because the design application rate of the sprinkler system is less than the infiltration rate of the soil-vegetation surface. However, some runoff from systems on steep (10 to 30%) hillsides should be anticipated. In these cases, runoff can be temporarily stored behind small check dams located in natural drainage courses. The stored runoff can be reapplied with portable sprinkling equipment.

4.8.2.2 Stormwater Runoff Provisions

For SR systems, control of stormwater runoff to prevent erosion is necessary. Terracing of steep slopes is a well known agricultural practice to prevent excessive erosion. Sediment control basins and other nonstructural control measures, such as contour plowing, no-till farming, grass border strips, and stream buffer zones can be used. Since wastewater application will usually be stopped during storm runoff conditions, recirculation of storm runoff for further treatment is usually unnecessary. Channels or waterways that carry stormwater runoff to discharge points should be designed with a capacity to carry runoff from a storm of a specified return frequency (10 year minimum).

4.9 System Management

4.9.1 Soil Management

Management of the soil involves tillage operations and maintenance of the proper soil chemical properties including plant nutrient levels, pH, sodium levels, and salinity levels. Much of what is discussed under soil management refers to agricultural crop systems, since most forest crop systems require very little soil management.

4.9.1.1 Tillage Operations

One of the principal objectives of tillage operations is to maintain or enhance the infiltration capacity of the soil surface and the permeability of the entire soil profile. In general, tillage operations that expose bare soil should be kept to a minimum. Minimum tillage and no-till methods conserve fuel, reduce labor costs, and minimize compaction of soils by heavy equipment. Conventional plowing (20 to 25 cm or 8 to 10 in.) and preparation of a seedbed free of weeds and trash are necessary for most vegetables and root crops. Many field crops, however, can be planted directly in sod or residues from a previous crop or after partial incorporation of residues by shallow disking. Crop residues left on the surface or partially incorporated to a depth of 8 or 10 cm (3 or 4 in.) provide protection against runoff and erosion during intervals between crops. The decomposition of residues on or near the soil surface helps to maintain a friable, open condition conducive to good aeration and rapid infiltration of water. Actively decomposing organic matter also helps to reduce the concentration of other soluble pollutants and can hasten the conversion of toxic organics, like pesticides, to less toxic products.

At sites where clay pans have formed and reduce the effective permeability of the soil profile, it may be necessary to plow very deeply (60 to 180 cm or 2 to 6 ft) to mix impermeable subsoil strata with more permeable surface materials. Impermeable pans formed by vehicular traffic (plow pans) or by cementation of fine particles (hard pans) can be broken up by subsoiling equipment that leaves the surface protected by vegetation or stubble. To be effective, however, the subsoiling equipment must completely break through the pan layers. This is difficult if the pan layers are more than 30 cm (1 ft) thick. Local soil conservation district personnel should be consulted regarding tillage practices appropriate for specific crops, soils, and terrain.

4.9.1.2 Nutrient Status

During design, it is recommended that the nutrient status of the soil be evaluated. Periodic evaluation is recommended as part of the system monitoring program (Section 4.10).

Sufficient nitrogen, phosphorus, and most other essential nutrients for plant growth are generally supplied by most wastewaters. Potassium is the nutrient most likely to be deficient since it is usually present in low concentrations in wastewater. For soils having low levels of natural potassium, the following relationship has been developed to estimate potassium fertilizer requirements:

$$K_f = 0.9U - K_{ww} \quad (4-13)$$

where K_f = annual fertilizer potassium needed, kg/ha

U = estimated annual crop uptake of nitrogen, kg/ha

K_{ww} = amount of potassium applied in wastewater, kg/ha

On the basis of commonly used test methods for available nutrients, the University of California Agricultural Extension Service has developed a summary of adequate available levels in the soil of the nutrients most commonly deficient for some selected crops. This summary is presented in Table 4-26. Critical values for nitrogen are not included because there are no well accepted methods for determining available nitrogen.

Table 4-26
APPROXIMATE CRITICAL LEVELS OF NUTRIENTS
IN SOILS FOR SELECTED CROPS IN CALIFORNIA

Nutrient	Approximate critical range, ppm	Test method
Phosphorus		0.5 M NaHCO ₃ extraction at pH 8.5
Range and pasture	10	
Field crops and warm season vegetables	5-9	
Cool season vegetables	12-20	
Potassium		1.0 N ammonium acetate extraction at pH 7.0
Grain and alfalfa	45-55	
Cotton	55-65	
Potatoes	90-110	
Zinc	0.4-0.6	DPTA extraction

4.9.1.3 Soil pH Adjustment

In general, a pH less than 4.2 is too acid for most crops and above 8.4 is too alkaline for most crops. The optimum pH range for crop growth depends on the type of crop. Extremes in the soil pH also can affect the performance of an SR system or indicate problem conditions. Below pH 6.5, the capacity of the soil to retain metal is reduced. A soil pH above 8.5 generally indicates a high sodium content and possible permeability problems.

The pH of soils can be adjusted by the addition of liming materials or acidulating chemicals. A pH adjustment program should be based on the recommendations of a professional agricultural consultant or county or state farm adviser.

4.9.1.4 Exchangeable Sodium Control

Soils containing excessive exchangeable sodium are termed "sodic" soils. A soil is considered sodic when the percentage of the total cation exchange capacity (CEC) occupied by sodium, the exchangeable sodium percentage (ESP), exceeds 15%. High levels of sodium cause low soil permeability, poor soil aeration, and difficulty in seedling emergence. Fine-textured soil may be affected at an ESP above 10%, but coarse-textured soil may not be damaged until the ESP reaches about 20%. The ESP should be determined by laboratory analysis before design if sodic soils are known to exist in the area of the site. Sodic soil conditions may be corrected by adding soluble calcium to the soil to displace the sodium on the exchange and removing the displaced sodium by leaching. Advice on correcting sodic soils should be obtained from agricultural consultants or farm advisers.

4.9.1.5 Salinity Control

Salinity control may be necessary in arid climates where natural rainfall is insufficient to flush salts from the root zone. The salinity level of a soil is usually measured on the basis of the electrical conductivity of an extract solution from a saturated soil (EC_e). Saline soils are defined as those yielding an EC_e value greater than 4,000 micromhos/cm at 25 °C (77 °F).

Soils that are initially saline may be reclaimed by leaching; however, management of the leachate is often required to protect ground water quality. The U.S. Department of Agriculture's Handbook 60 [45] deals with the diagnosis and improvement of such soils for agricultural purposes. This reference can be used as a practical guide

for managing saline and saline-sodic soil conditions in arid and semiarid regions.

4.9.2 Crop Management

Because of their substantially different requirements, the management of agricultural crops and forest crops are discussed separately.

4.9.2.1 Agricultural Crop Planting and Harvesting

Local extension services or similar experts should be consulted regarding planting techniques and schedules. Most crops require a period of dry weather before harvest to mature and reach a moisture content compatible with harvesting equipment. Soil moisture at harvest time should be low enough to minimize compaction by harvesting equipment. For these reasons, application should be discontinued well in advance of harvest. The time required for drying will depend on the soil drainage and the weather. A drying time of 1 to 2 weeks is usually sufficient if there is no precipitation. However, advice on this should be obtained from local agricultural experts.

Harvesting of grass crops and alfalfa involves regular cuttings, and a decision regarding the trade-off between yield and quality must be made. Advice can be obtained from local agricultural experts. In the northeast and north central states, three cuttings per season have been successful with grass crops.

4.9.2.2 Grazing

Grazing of pasture by beef cattle or sheep can provide an economic return for SR systems. No health hazard has been associated with the sale of the animals for human consumption.

Grazing animals return nutrients to the ground in their waste products. The chemical state (organic and ammonia nitrogen) and rate of release of the nitrogen reduces the threat of nitrate pollution of the ground water. Much of the ammonia-nitrogen volatilizes and the organic nitrogen is held in the soil where it is slowly mineralized to ammonium and nitrate forms. Steer and sheep manure contain approximately 20% nitrogen after volatile losses, of which about 40% is mineralized in the first year, 25% in the second, and 6% in successive years [41].

In terms of pasture management, cattle or sheep must not be allowed on wet fields to avoid severe soil compaction and

reduced soil infiltration rates. Wet grazing conditions can also lead to animal hoof diseases. Pasture rotation should be practiced so that wastewater can be applied immediately after the livestock are removed. In general, a pasture area should not be grazed longer than 7 days. Typical regrowth periods between grazings range from 14 to 35 days. Depending on the period of regrowth provided, one to three water applications can be made during the regrowth period. Rotation grazing cycles for 3 to 8 pasture areas are given in Table 4-27. At least 3 to 4 days drying time following an application should be allowed before livestock are returned to the pasture.

Table 4-27
GRAZING ROTATION CYCLES FOR
DIFFERENT NUMBERS OF PASTURE AREAS

No. of pasture areas	Rotation cycle, days	Regrowth period, days	Grazing period, days
3	21	14	7
4	28	21	7
5	35	28	7
6	36	30	6
7	35	28	7
8	32	28	4

4.9.2.3 Agricultural Pest Control

Problems with weeds, insects, and plant diseases are aggravated under conditions of frequent water application, particularly when a single crop is grown year after year or when no-till practices are used. Most pests can be controlled by selecting resistant or tolerant crop varieties and by using pesticides in combination with appropriate cultural practices. State and local experts should be consulted in developing an overall pest control program for a given situation.

4.9.2.4 Forest Crops

The type of forest crop management practice selected is determined by the species mix grown, the age and structure of the stand, the method of reproduction best suited and/or desired for the favored species, terrain, and type of equipment and technique used by local harvesters. The most typical forest management situations encountered in land treatment are management of existing forest stands, reforestation, and short-term rotation.

Existing Forest Ecosystems

The general objective of the forest management program is to maximize biomass production. The compromise between fully attaining a forest's growth potential and the need to operate equipment efficiently (distribution and harvesting equipment) requires fewer trees per unit area. These operations will assure maintenance of a high nutrient uptake, particularly nitrogen, by the forest.

For uneven-aged forests, the desired forest composition, structure, and vigor can be best achieved through thinning and selective harvest. However, excessive thinning can make trees susceptible to wind throw and caution is advised in windy areas. The objective of these operations would be to maintain an age class distribution in accordance with the concept of optimum nutrient storage (see Section 4.3). The maintenance of fewer trees than normal would permit adequate sunlight to reach the understory to promote reproduction and growth of the understory. Thinning should be done initially prior to construction of the distribution system and only once every 10 years or so to minimize soil and site damage.

In even-aged forests, trees will all reach harvest age at the same time. The usual practice is to clear-cut these forests at harvest age and regenerate a stand by either planting seedlings, natural seeding, sprouting from stumps (called coppice), or a combination of several of the methods. Even-aged stands may require a thinning at an intermediate age to maintain maximum biomass production. Coniferous forests, in general, must be replanted, whereas hardwood forests can be reproduced by coppice or natural seeding.

The concept of "whole-tree harvesting" should be considered for all harvesting operations, whether it be thinning, selection harvest, or clear-cut harvest. Whole-tree harvesting removes the entire standing tree: stem; branches, and leaves. Thus, 100% of the nitrogen accumulated in the aboveground biomass would be removed (see Section 4.3.2.1).

Prescribed fire is a common management practice in many forests to reduce the debris or slash left on the site during conventional harvesting methods. During the operation, a portion of the forest floor is burned and nitrogen is volatilized. Although this represents an immediate benefit in terms of nitrogen removal from the site, the buffering capacity that the forest floor offers is reduced and the likelihood of a nitrate leaching to the ground water is increased when application of wastewater is resumed.

Reforestation

Wastewater nutrients often stimulate the growth of the herbaceous vegetation to such an extent that they compete with and shade out the desirable forest species. Herbaceous vegetation is necessary to act as a nitrogen sink while the trees are becoming established, and therefore, cultural practices must be designed to control but not eliminate the herbaceous vegetation. As the tree crowns begin to close, the herbaceous vegetation will be shaded and its role in the renovation cycle reduced. Another alternative to control of the herbaceous vegetation is to eliminate it completely and reduce the hydraulic and nutrient loading during the establishment period.

Short-Term Rotation

Short-term rotation forests are plantations of closely spaced hardwood trees that are harvested repeatedly on cycles of less than 10 years. The key to rapid growth rates and biomass development is the rootstock that remains in the soil after harvest and then resprouts. Short-term rotation harvesting systems are readily mechanized because the crop is uniform and relatively small.

Using conventional tree spacings of 2.5 to 4 m (8 to 12 ft), research on systems where wastewater has been applied to short-term rotation plantations has shown that high growth rates and high nitrogen removal are possible [16]. Planted stock will produce only 50% to 70% of the biomass produced following cutting and resprouting [47, 48]. If nitrogen and other nutrient uptake is proportional to biomass, the first rotation from planted stock will not remove as much as subsequent rotations from coppice. Therefore, the initial rotation must receive a reduced nutrient load or other herbaceous vegetation must be employed for nutrient storage. Alternatively, closer tree spacings may be used to achieve desired nutrient uptake rates during initial rotation.

4.10 System Monitoring

The broad objectives of a monitoring program for an SR system are to determine if the effluent quality requirements are being met, to determine if any corrective action is necessary to protect the environment or maintain the renovative capacity of the system, and to aid in system operation. The components of the environment that need to be observed include water quality, the soils receiving wastewater, and in some cases, vegetation growing in soils that are receiving wastewater.

4.10.1 Water Quality Monitoring

Monitoring of water quality for land application systems can be more complex than for conventional treatment systems because nonpoint discharges of system effluent are involved. Monitoring of applied wastewater and renovated water quality is useful for process control. For SR systems, renovated water would only be monitored in cases where underdrains are used. Monitoring of receiving waters, surface or ground water, may be required by regulatory authorities.

In most cases, a water quality monitoring program, including constituents to be analyzed and frequency of analysis, will be prescribed by local regulatory agencies. It may be desired to monitor additional constituents or parameters for purposes of crop and soil management.

Ground water monitoring data are difficult to interpret unless sampling wells are located properly and correct sampling procedures are followed. In addition to quality, the depth to ground water should be measured at the sampling wells to determine if the hydraulic response of the aquifer is consistent with what was anticipated. For SR systems, a rise in water table levels to the root zone would necessitate corrective action such as reduced hydraulic loading or adding underdrainage. The appearance of seeps or perched ground water tables might also indicate the need for corrective action.

4.10.2 Soils Monitoring

In some cases, application of wastewater to the land will result in changes in soil properties. Results of soil sampling and testing will serve as the basis for deciding whether or not soil properties should be adjusted by the application of chemical amendments. Annual monitoring of the soil properties described in Section 4.9.1 is sufficient for most systems.

It is recommended that the level of trace elements of concern (see Chapter 9) in the soil be monitored every few years so that the rate of accumulation can be observed and toxic levels avoided. Total metal analysis by hot acid digestion is recommended for monitoring and comparison purposes.

4.10.3 Vegetation Monitoring

Plant tissue analysis is more revealing than soil analysis with regard to deficient or toxic levels of elements. If visual symptoms of nutrient deficiencies or toxicities appear, plant tissue testing can be used for confirmation, and corrective action can be taken. A regular plant tissue monitoring program can often detect deficiencies or toxicity before visual symptoms and damage to the plant occurs.

Nitrate should be determined in forages or leafy vegetables if there is reason to suspect concentrations which might be toxic to livestock. Detailed information on plant sampling and testing may be found in references [49, 50]. Extension specialists or local farm advisers should be consulted regarding plant tissue testing.

4.11 Facilities Design Guidance

The purpose of this section is to provide guidance on aspects of facilities design that may be unfamiliar to some environmental engineers.

- Standard surface irrigation practice is to produce longitudinal slopes of 0.1 to 0.2% with transverse slopes not exceeding 0.3%.
 - Step 1. Rough grade to 5 cm (0.15 ft) at 30 m (100 ft) grid stations.
 - Step 2. Finish grade to ± 3 cm (0.10 ft) at 30 m (100 ft) grid stations with no reversals in slope between stations.
 - Step 3. Land plane with a 18 m (60 ft) minimum wheel base, land plane to a "near perfect" finished grade.
- Access to sprinklers or distribution piping should be provided every 390 m (1,300 ft) for convenient maintenance.
- Both asbestos-cement and PVC irrigation pipe are rather fragile and require care in handling and installation.
- Diaphragm-operated globe valves are recommended for controlling flow to laterals.
- All electric equipment should be grounded, especially when associated with center pivot systems.

- Automatic controls can be electrically, hydraulically, or pneumatically operated. Solenoid actuated, hydraulically operated (by the wastewater) valves with small orifices will clog from the solids.
- Valve boxes, 1 m (36 in.) or larger, should be made of corrugated metal, concrete, fiber glass, or pipe material. Valve boxes should extend 15 cm (6 in.) above grade to exclude stormwater.
- Low pressure shutoff valves should be used to avoid continuous draining of the lowest sprinkler on the lateral.
- Automatic operation can be controlled by timer clocks. It is important that when the timer shuts the system down for any reason that the field valves close automatically and that the sprinkling cycles resume as scheduled when sprinkling commences. The clock should not reset to time zero when an interruption occurs.
- High flotation tires are recommended for land treatment system vehicles. Recommended soil contact pressures for center pivot machines are presented in Table 4-28.

TABLE 4-28
RECOMMEDED SOIL CONTACT PRESSURE

% fines	N/cm ²	lb/in. ²
20	17	25
40	11	16
50	8	12

Note: To illustrate the use of this table, if 20% of the soil fines pass through a 200-mesh screen, the contact pressure of the supporting structure to the ground should be no more than 17 N/cm² (25 lb/in.²). If this is exceeded, one can expect wheel tracking problems to occur.

4.12 References

1. Benham-Blair and Affiliates, Inc. and Engineering Enterprises, Inc. Long-term Effects of Land Application of Domestic Wastewater: Dickinson, North Dakota, Slow Rate Irrigation Site. U.S. Environmental Protection Agency. EPA-600/2-79-144. August 1979.
2. Demirjian, Y.A. et al. Muskegon County Wastewater Management System. U.S. Environmental Protection Agency. EPA-905/2-80-004. February 1980.
3. Hossner, L.R., et al. Sewage Disposal on Agricultural Soils: Chemical and Microbiological Implications (San Angelo, Texas). U.S. Environmental Protection Agency. EPA-600/2-78-131a,b. June 1978.
4. Jenkins, T.F. and A.J. Palazzo. Wastewater Treatment by a Slow Rate Land Treatment System. U.S. Army Corps of Engineers, Cold Regions Research and Engineering Laboratory. CRREL Report 81-14. Hanover, New Hampshire. August 1981.
5. Koerner, E.L. and D.A. Haws. Long-Term Effects of Land Application of Domestic Wastewater: Roswell, New Mexico, Slow Rate Irrigation Site. U.S. Environmental Protection Agency. EPA-600/2-79-647. February 1979.
6. Iskandar, I.K., R.P. Murrmann, and D.C. Leggett. Evaluation of Existing Systems for Land Treatment of Wastewater at Manteca, California and Quincy, Washington. U.S. Army Cold Regions Research and Engineering Laboratory. CRREL Report 77-24. September 1977.
7. Nutter, W.L., R.C. Schultz, and G.H. Brister. Land Treatment of Municipal Wastewater on Steep Forest Slopes in the Humid Southeastern United States. Proceedings of Symposium on Land Treatment of Wastewater. Hanover, New Hampshire. August 20-25, 1978.
8. Stone, R. and J. Rowlands. Long-Term Effects of Land Application of Domestic Wastewater: Mesa, Arizona, Irrigation Site. U.S. Environmental Protection Agency. EPA-600/2-80-061. April 1980.
9. Enfield, C.G. and B.E. Bledsoe. Kinetic Model for Orthophosphate Reactions in Mineral Soils. EPA-660/2-75-002. U.S. Government Printing Office. June 1975.

10. Land as a Waste Management Alternative. R.C. Loehr, ed. Ann Arbor Science. Ann Arbor, Michigan. 1977.
11. Overman, A.R. Wastewater Irrigation at Tallahassee, Florida. U.S. Environmental Protection Agency. EPA-600/2-79-151. August 1979.
12. Stone, R. and J. Rowlands. Long-Term Effects of Land Application of Domestic Wastewater: Camarillo, California, Irrigation Site. U.S. Environmental Protection Agency. EPA-600/2-80-080. May 1980.
13. Tofflemire, T.J. and M. Chen. Phosphate Removal by Sands and Soils. In: Land as a Waste Management Alternative. Loehr, R.C. (ed). Ann Arbor, Ann Arbor Science. 1977.
14. Uiga, A. and R.W. Crites. Relative Health Risks of Activated Sludge Treatment and Slow Rate Land Treatment. Journal WPCF, 52(12):2865-2874. December 1980.
15. Pratt, P.F. Quality Criteria for Trace Elements in Irrigation Waters. University of California, Riverside, Department of Soil Science and Agricultural Engineering. 1972.
16. National Academy of Science. Water Quality Criteria 1972. Ecological Research Series. U.S. Environmental Protection Agency. Report No. R3-73-033. March 1973.
17. U.S. Environmental Protection Agency. Preliminary Survey of Toxic Pollutants at the Muskegon Wastewater Management System. Robert S. Kerr Environmental Research Laboratory, Groundwater Research Branch. Ada, Oklahoma. 1977.
18. Hinrichs, D.J. Design of Irrigation Systems for Agricultural Utilization of Effluent. Presented at the California Water Pollution Control Association Annual Conference, Monterey, Calif. May 1, 1980.
19. Smith, W.H. and J.O. Evans. Special Opportunities and Problems in Using Forest Soils for Organic Waste Application. In: Soils for Management of Organic Wastes and Waste Waters. ASA, CSSA, SSSA, Madison, Wisconsin. pp. 429-451. 1977.
20. Palazzo, A.J., and J.M. Graham. Seasonal Growth and Uptake of Nutrients by Orchardgrass Irrigated with Wastewater. U.S. Army Cold Regions Research and Engineering Laboratory. CRREL Report 81-8. June 1981.

21. Duscha, L.A. Dual Cropping Procedure for Slow Infiltration of Land Treatment of Municipal Wastewater. Department of the Army, Engineering Technical Letter No. 1110-2-260. March 12, 1981.
22. McKim, H.L., et al. Wastewater Application in Forest Ecosystems. CRREL Report 119, Corps of Engineers, U.S. Army. May 1980.
23. USDA Forest Service. Impact of Intensive Harvesting on Forest Nutrient Cycling. Northeast Forest Experiment Station. Broomall, Pa. 1979.
24. Jensen, M.E. (ed.). Consumptive Use of Water and Irrigation Water Requirements. ASCE. ASCE Committee on Irrigation Water Requirements. 1973.
25. Doorenbos, J. and W.O. Pruitt. Guidelines for Predicting Crop Water Requirements. Irrigation and Drainage Paper 24. Presented at United Nations Food and Agriculture Organization. Rome. 1975.
26. Irrigation Water Requirements. Technical Release No. 21, U.S. Department of Agriculture, Soil Conservation Service. September 1970.
27. Vegetative Water Use in California, 1974. Bulletin No. 113-3, State of California Department of Water Resources. April 1975.
28. Booher, L.J. and G.V. Ferry. Estimated Consumptive Use and Irrigation Requirements of Various Crops. University of California Agricultural Extension Service, Bakersfield, Calif. March 10, 1970.
29. Ayers, R.S. Quality of Water for Irrigation, Jour. of the Irrigation and Drainage Division, ASCE, Vol. 103, No. IR2. June 1977. pp. 135-154.
30. U.S. Environmental Protection Agency. Facilities Planning, 1982. EPA-430/9-81-012. FRD-25. September 1981.
31. Reed, S.C. Treatment/Storage Ponds for Land Application Systems. CRREL Special Report. December 1981.
32. Environmental Protection Agency. Process Design Manual for Wastewater Treatment Ponds (In Preparation).
33. Bowles, D.S., et al. Coliform Decay Rates in Waste Stabilization Ponds, Journal WPCF, 51(1):87-99, January 1979.

34. Sagik, B.P. et al. The Survival of Human Enteric Viruses in Holding Ponds. Contract Report DAMD 17-75-C-5062. U.S. Army Medical Research and Development Command. 1978.
35. Whiting, D.M. Use of Climatic Data in Estimating Storage Days for Soil Treatment Systems. Environmental Protection Agency, Office of Research and Development. EPA-600/2-76-250. November 1976.
36. Whiting, D.M. Use of Climatic Data in Design of Soil Treatment Systems. EPA-660/2-75-018. Environmental Protection Agency, Office of Research and Development. July 1975.
37. U.S. Department of the Interior, Bureau of Reclamation. Design of Small Dams. Second Edition. U.S. Government Printing Office. 1973.
38. Booher, L.J. Surface Irrigation. FAO Agricultural Development Paper No. 95. Food and Agricultural Organization of the United Nations. Rome. 1974.
39. Myers, E.A. Design and Operational Criteria for Forest Irrigation Systems. In: Utilization of Municipal Sewage Effluent and Sludge on Forest and Disturbed Land. The Pennsylvania State University Press, University Park, Pa. p. 265-272. 1979.
40. Evaluation of Land Application Systems. U.S. Environmental Protection Agency. EPA-430/9-75-001. March 1975.
41. Luthin, J.N. (ed.). Drainage of Agricultural Lands. Madison, American Society of Agronomy. 1957.
42. Van Schilfgaarde, J, ed. Drainage for Agriculture. American Society of Agronomy, Madison, Wisconsin. 1974.
43. Drainage of Agricultural Land. A Practical Handbook for the Planning, Design, Construction, and Maintenance of Agricultural Drainage Systems. U.S. Department of Agriculture, Soil Conservation Service. October 1972.
44. Hart, W.E. Irrigation System Design, Colorado State University, Department of Agricultural Engineering. Fort Collins, Colorado. November 10, 1975.
45. Richards, L.A. (ed.). Diagnosis and Improvement of Saline and Alkali Soil. Agricultural Handbook 60. U.S. Department of Agriculture. 1954.

46. California Fertilizer Assn. Western Fertilizer Handbook Sixth Ed. The Interstate Printers and Publishers. 1980.
47. Saucier, J.R. Estimation of Biomass Production and Removal. In: Impact of Intensive Harvesting on Forest Nutrient Cycling. College of Environmental Science and Forestry, State University of New York, Syracuse, New York, p. 172-189. 1979.
48. Steinbeck, K. and C.L. Brown. Yield and Utilization of Hardwood Fiber Grown on Short Rotations. Applied Polymer Symposium 28: 393-401. 1976.
49. Walsh, L.M. and J.D. Beaton, (eds.). Soil Testing and Plant Analysis. Madison, Soil Science Society of America. 1973.
50. Melsted, S.W. Soil-Plant Relationships (Some Practical Considerations in Waste Management). In: Proceedings of the Joint Conference on Recycling Municipal Sludges and Effluents on Land, Champaign, University of Illinois. July 1973. pp. 121-128.

CHAPTER 5

RAPID INFILTRATION PROCESS DESIGN

5.1 Introduction

The design procedure for rapid infiltration (RI) is diagrammed in Figure 5-1. As indicated by this figure, there are several major elements in the design process and the design approach is somewhat iterative. For example, the amount of land required for an RI system is a function of the loading rate, which is affected by the loading cycle and the level of preapplication treatment. If the engineer initially assumes a level of preapplication treatment and a loading cycle that result in a loading rate requiring more land than is available at the selected site, the level of preapplication treatment and loading cycle can be reevaluated to reduce the land area required.

5.1.1 RI Hydraulic Pathway

The engineer and the community must decide which hydraulic pathway (see Figure 1-2) is appropriate for their situation. This decision is based on the hydrogeologic characteristics of the selected site and regulatory agency decisions.

5.1.2 Site Work

For RI design, the results of the field investigations (Chapter 3) must be analyzed and interpreted. Backhoe pits and drill holes are needed to establish the depth and hydraulic conductivity of the permeable material and the depth to ground water. Sufficient subsurface information must be obtained in the Phase 2 planning process (Chapter 2) to allow the engineer to calculate:

1. Infiltration rate (Section 5.4)
2. Subsurface flow (Section 5.7)
 - Potential for mounding
 - Drainage (if needed)
 - Natural seepage (if adequate)
3. Mixing of percolate with ground water (if critical to meet performance requirements)

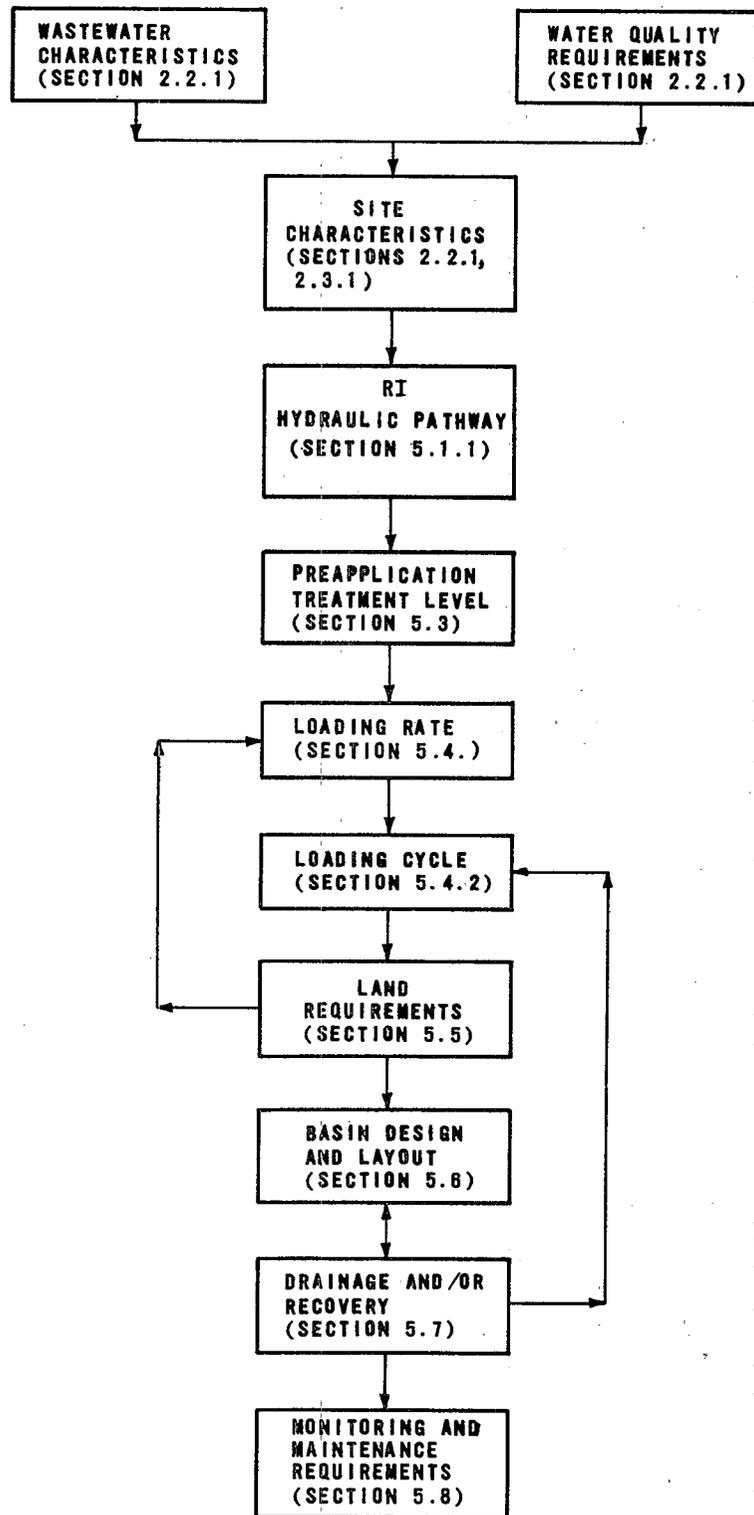

FIGURE 5-1
RAPID INFILTRATION DESIGN PROCEDURE

5.2 Process Performance

The RI mechanisms for removal of wastewater constituents such as BOD, suspended solids, nitrogen, phosphorus, trace elements, microorganisms, and trace organics are discussed briefly along with typical results from various operating systems. Chapter 9 contains discussions of the health and environmental effects of these constituents.

5.2.1 BOD and Suspended Solids

Particulate BOD and suspended solids are removed by filtration at or near the soil surface. Soluble BOD may be adsorbed by the soil or may be removed from the percolating wastewater by soil bacteria. Eventually, most BOD and suspended solids that are removed initially by filtration are degraded and consumed by soil bacteria. BOD and suspended solids removals are generally not affected by the level of preapplication treatment. However, high hydraulic loadings of wastewaters with high concentrations of BOD and suspended solids can cause clogging of the soil. Typical BOD loadings (Table 2-3) are less than 130 kg/ha·d (115 lb/acre·d) for municipal wastewaters. Removals achieved at selected RI systems are presented in Table 5-1. Some systems have been operated successfully at higher loadings.

5.2.2 Nitrogen

The primary nitrogen removal mechanism in RI systems is nitrification-denitrification. This mechanism involves two separate steps: the oxidation of ammonia nitrogen to nitrate (nitrification) and the subsequent conversion of nitrate to nitrogen gas (denitrification). Ammonium adsorption also plays an important intermediate role in nitrogen removal.

Both nitrification and denitrification are accomplished by soil bacteria. The optimum temperature for nitrogen removal is 30 °C to 35 °C (86 °F to 95 °F). Both processes proceed slowly between 2 °C and 5 °C (36 °F and 41 °F) and stop near the freezing point of water. Nitrification rates decline sharply in acid conditions and reach a limiting value at approximately pH 4.5. The denitrification reaction rate is reduced substantially at pH values below 5.5. Thus, both soil temperature and pH must be considered if nitrogen removal is important (Section 5.4.3.1). Furthermore, alternating aerobic and anaerobic conditions must be provided for significant nitrogen removal (Section 5.4.2). Because aerobic bacteria deplete soil oxygen during flooding periods, resting and flooding periods must be alternated to result in alternating aerobic and anaerobic soil conditions.

TABLE 5-1
BOD REMOVAL DATA FOR
SELECTED RI SYSTEMS [1-6]

Location	Preapplication treatment	Sampling depth, m	BOD		
			Average loading rate, kg/ha·d ^a	Treated water concentration, mg/L	Removal, %
Calumet, Michigan	Untreated	3.3	80	11 ^b	86
Fort Devens, Massachusetts	Primary	20	87	12	86
Hollister, California	Primary	8	177	8 ^c	95
Lake George, New York	Trickling filters	3	53	1.2	98
Milton, Wisconsin	Activated sludge	8-29	155	1.0-19.0	88-99
Phoenix, Arizona	Activated sludge	6-9	45	0-1	98-100
Vineland, New Jersey	Primary	2-14	48	6.5 ^c	86

a. Total kg/ha·yr applied divided by the number of days in the operating season (365 days for these cases).

b. Soluble total organic carbon.

c. Average value from several wells.

Note: See Appendix G for metric conversions.

Organic carbon is needed in the applied wastewater to supply energy for the denitrification reaction. Approximately 2 mg/L of total organic carbon (TOC) is needed to denitrify 1 mg/L of nitrogen. Because the BOD concentration decreases as the level of preapplication treatment increases, preapplication treatment must be limited if denitrification is to occur in the soil. Thus, if the goal of RI is nitrogen removal, primary preapplication treatment is preferred.

Nitrogen removal efficiencies at various operating RI systems are shown in Table 5-2. As shown in this table, nitrogen removals of approximately 50% are typical. Greater amounts can be removed using special management procedures (Section 5.4.3.1).

TABLE 5-2
NITROGEN REMOVAL DATA FOR SELECTED RI
SYSTEMS [1,2,4,6-9]

Location	Concentration in applied wastewater: total N, mg/L	Loading rate, m/yr	BOD:N ratio	Flooding to drying time ratio	Concentration in renovated water, mg/L		Removal, % of total N
					NO ₃ -N	Total N	
Boulder, Colorado	16.5	48.8	2.3:1	1:3	6-16	9-16	10-20
Brookings, South Dakota	10.9	12.2	2:1	1:2	5.3	6.2	43
Calumet, Michigan	24.4	17.1	3.6:1	1:2	3.4	7.1	71
Disney World, Florida	--	54.9	0.3:1	150:14	--	--	12
Fort Devens, Massachusetts	50	30.5	2.4:1	2:12	13.6	19.6	61
Hollister, California	40.2	15.2	5.5:1	1:14	0.9	2.8	93
Lake George, New York	11.5 12.0	58.0 58.0	2:1 2:1	1:4 1:4	-- --	7.70 7.50	33 38
Phoenix, Arizona	27.4	61.0	1:1	9:12	6.2	9.6.	65

At some sites the goal of RI may be only nitrification (for example, Boulder, Colorado). Generally, nitrification occurs if wastewater application periods are short enough that the upper soil layers remain aerobic. For this reason, if nitrification is the objective of RI, short application periods followed by somewhat longer drying periods are used. Because the nitrification rate decreases during winter months, reduced loading rates may be required in cold climates. Under favorable temperature and moisture conditions, up to 50 ppm ammonia nitrogen (as nitrogen) per day (soil basis) may be converted to nitrate [10]. Assuming that nitrification only occurs in the top 10 cm (4 in.) of soil, this corresponds to nitrification rates of up to 67 kg/ha·d (60 lb/acre·d). At the Boulder, Colorado, RI system, the percolate ammonia concentration remained below 1 mg/L on a year-round basis.

5.2.3 Phosphorus

The primary phosphorus removal mechanisms in RI systems are the same as described in Section 4.2.3 for SR. Phosphorus removals achieved at typical RI systems are provided in Table 5-3.

TABLE 5-3
PHOSPHORUS REMOVAL DATA FOR SELECTED
RI SYSTEMS [1, 2, 4-9]

Location	Average concentration in applied wastewater, mg/L	Distance of travel, m		Average concentration in renovated wastewater, mg/L	Removal, %
		Vertical	Horizontal		
Boulder, ^a Colorado	6.2	2.4-3.0	0	0.2-4.5	40-97
Brookings, South Dakota ^b	3.0	0.8	0	0.45	85
Calumet, ^a Michigan	3.5 3.5	3-9 -- ^c	0-125 1,700 ^c	0.1-0.4 0.03	89-97 99
Fort Devens, Massachusetts ^b	9.0	15	30	0.1	99
Hollister, California ^b	10.5	6.8	0	7.4	29
Lake George, New York ^b	2.1 2.1	3 -- ^c	0 600 ^c	<1 0.014	>52 99
Phoenix, Arizona ^a	8-11 7.9	9.1 6	0 30	2-5 0.51	40-80 94
Vineland, New Jersey ^b	4.8 4.8	2-18 4-16	0 260-530	1.54 0.27	68 94

- a. Total phosphate measured.
- b. Soluble phosphate measured.
- c. Seepage.

5.2.4 Trace Elements

Trace element removal involves essentially the same mechanisms discussed in Section 4.2.4 for SR systems. The results presented in Table 5-4 compare trace element concentrations in wastewater at Hollister, California, to drinking water and irrigation requirements.

At RI sites, trace elements accumulate in the upper soil layers. Data from Cape Cod, Massachusetts, reflect this phenomenon and are presented in Table 5-5. As indicated in this table, the percent retention of most of the metals is quite high. For example, 85% of the copper applied over 33 years was retained in the top 0.52 m (1.7 ft). The distribution of the retained metals is also shown in Table 5-5.

TABLE 5-4
 COMPARISON OF TRACE ELEMENT LEVELS TO
 IRRIGATION AND DRINKING WATER LIMITS [6]
 mg/L

Element	Recommended maximum in irrigation waters	Maximum concentration in drinking waters	Hollister, California, average wastewater concentration
Ag (silver)	-- ^a	0.05	<0.008
As (arsenic)	0.1	0.05	<0.01
Ba (barium)	-- ^a	1.0	<0.13
Cd (cadmium)	0.01	0.010	<0.004
Co (cobalt)	0.1	-- ^a	<0.008
Cr (chromium)	0.05	0.05	<0.014
Cu (copper)	0.2	-- ^a	0.034
Fe (iron)	5.0	-- ^a	0.39
Hg (mercury)	-- ^a	0.002	<0.001
Mn (manganese)	0.2	-- ^a	0.070
Ni (nickel)	0.2	-- ^a	0.051
Pb (lead)	5.0	0.05	0.054
Se (selenium)	0.02	0.01	<0.001
Zn (zinc)	2.0	-- ^a	0.048

a. None set.

TABLE 5-5
 HEAVY METAL RETENTION IN AN
 INFILTRATION BASIN^a

Percent

Depth, m	Cadmium	Chromium	Copper	Lead	Zinc
0-0.04	84	87	76	88	82
0.04-0.06	12	10	23	12	13
0.14-0.16	1	0	0.4	0	1
0.24-0.26	1	2	0.4	0	2
0.29-0.31	1	0	0.1	0	0.8
0.44-0.46	0.5	1	0.1	0	1.2
0.50-0.52	<u>0.5</u>	<u>0</u>	<u>0.0</u>	<u>0</u>	<u>0</u>
Total	100	100	100	100	100
Percent retention of 33 year loads					
0-0.52	113	62	85	129	49

a. Adapted from reference [11].

5.2.5 Microorganisms

Removal mechanisms for microorganisms are discussed in Section 4.2.5.

Fecal coliform removal efficiencies obtained at selected RI sites are given in Table 5-6. As shown in this table, effective removal of fecal coliforms can be achieved with adequate travel distance.

TABLE 5-6
FECAL COLIFORM REMOVAL DATA FOR
SELECTED RI SYSTEMS [1, 3-6, 12]

Location	Soil type	Fecal coliforms, MPN/100 mL		Distance of travel, m
		Applied wastewater	Renovated water	
Hemet, California	Sand	60,000	11	2
Hollister, California	Sandy loam	12,400,000	171,000	7
Lake George, New York	Sand	359,000 359,000	72 0	2 7
Landis, New Jersey	Sand and gravel	TNTC ^a	16	1-2
Milton, Wisconsin	Gravelly sands	TNTC ^a	0	8-17
Phoenix, Arizona	Sand	244,071 244,071	104 0	30 90
Santee, California	Gravelly sands	130,000 130,000	580 <2	61 762
Vineland, New Jersey	Sand and gravel	TNTC ^a	0	6-7

a. At least one sample too numerous to count.

The primary removal mechanism for viruses is adsorption. Because of their small size, viruses are not removed by filtration at the soil surface, but instead, travel into the soil profile. Only a limited number of studies have been conducted to determine the efficiency of virus removal. At Phoenix, Arizona, results indicate that 90 to 99% of the applied virus is removed within 10 cm (4 in.) of travel when either primary or secondary effluent is applied [13, 14] and that 99.99% removal is achieved during travel through 9 m (30 ft) of soil following the application of secondary effluent [15].

The only RI sites at which viruses have been detected in ground water, and the distances traveled by the virus prior to detection are listed in Table 5-7. As noted in the

table, all four of these sites are located on coarse sand and gravel type soils. Infiltration rates on these soils are relatively high, allowing constituents in the applied wastewater to travel greater distances than normally expected. Thus, the coarser the soil is, the higher the loading rate, and the higher the virus concentration, the greater the risk of virus migration.

TABLE 5-7
REPORTED ISOLATIONS OF VIRUS AT RI SITES [16]

Location	Soil type	Distance of migration, m	
		Vertical	Horizontal
East Meadows, New York	Sands and gravel	11.3	3
Fort Devens, Massachusetts ^a	Sands and gravel	18.3	183
Holbrook, New York	Sands and gravel	6.1	45.7
Vineland, New Jersey ^a	Sands and gravel	16.8	250

a. Application of unchlorinated primary effluent.

5.2.6 Trace Organics

Trace organics can be removed by volatilization, sorption, and degradation. Degradation may be either chemical or biological; trace organic removal from the soil is primarily the result of biological degradation.

Studies to determine trace organic removal efficiencies during RI were conducted at the Vineland and Milton sites [3, 5]. At these two systems, applied effluent and ground water were analyzed for six pesticides and the results of the studies are summarized in Table 5-8. At both locations, the concentrations of 2,4-D, 2,4,5-TP, silvex, and lindane were well below the maximum concentrations for domestic water supplies established in the National Primary Drinking Water Regulations.

If local industries contribute large concentrations of synthetic organic chemicals and the RI system overlies a potable aquifer, industrial pretreatment should be considered. Further, since chlorination prior to land application causes formation of chlorinated trace organics that may be more difficult to remove, chlorination before application should be avoided whenever possible.

TABLE 5-8
RECORDED TRACE ORGANIC CONCENTRATIONS
AT SELECTED RI SITES [3,5]
ng/L

Pesticide	Vineland, New Jersey ^a			Milton, Wisconsin			
	Applied	Shallow ground water	Control ground water	Applied	Shallow ground water ^b	Down-gradient ^c	Control ground water
Endrin	<0.03	<0.03	<0.03	<0.03	<0.03	<0.03	<0.03
Lindane	2,830- 1,227	453- 1,172	21.3	41	157.6	3.9	7.4
Methoxychlor	<0.01	<0.01	<0.01	<0.01	<0.01	<0.01	<0.01
Toxaphene	<0.1	<0.1	<0.1	<0.1	<0.1	<0.1	<0.1
2,4-D	9.5- 10.5	16.4- 13.0	10.4	53.8	92.4	23.6	31.0
2,4,5-TP silvex	72	26.8- 120	185	16.2	41.2	38.7	76.8

- a. If two values are listed, the first is for the Vineland site and the second is for the Landis site (see reference [5]). If one value is listed, results were the same at both sites.
- b. Shallow ground water was sampled directly below infiltration basins.
- c. Ground water sampled approximately 45 m (148 ft) downgradient from the infiltration basins.

5.3 Determination of Preapplication Treatment Level

The first step in designing an RI system is to determine the appropriate level of preapplication treatment. This section describes the factors that should be considered as well as the levels of preapplication treatment that should be used to meet various treatment objectives.

5.3.1 EPA Guidance

EPA has issued guidelines suggesting the following levels of preapplication treatment for RI systems [17]:

- Primary treatment in isolated locations that have restricted public access
- Biological treatment by lagoons or in-plant processes at urban sites that have controlled public access

5.3.2 Water Quality Requirements and Treatment Goals

Preapplication treatment is used to reduce soil clogging and to reduce the potential for nuisance conditions (particularly odors) developing during temporary storage at the application site. If surface discharge is required and ammonia discharge requirements are stringent, the treatment

objective should be to maximize nitrification. In all other cases, system design is based on achieving the maximum, cost-effective loading rate that provides the required level of overall treatment.

For all systems, the equivalent of primary treatment is the minimum recommended preapplication treatment. This level of treatment reduces wear on the distribution system, prevents unmanageable soils clogging, reduces the potential for nuisance conditions, and allows the potential for maximum nitrogen removal.

Nitrification may be achieved using either primary or secondary preapplication treatment. For this reason, the selection of a preapplication treatment level to maximize nitrification at a specific site is based on the same factors that influence the selection of a preapplication treatment level for maximizing infiltration rates.

In mild climates, ponds can be used if land is relatively plentiful and not expensive. In areas that experience cold winter weather, it may not be possible to operate RI systems that use ponds for preapplication treatment. Also, if ponds are used prior to infiltration, algae carryover may increase the potential for soil clogging. Ponds can also be used to reduce the nitrogen loading (Section 4.4.1).

Recommended levels of preapplication treatment are summarized in Table 5-9. This table should be used only as a guide; the designer should select preapplication treatment facilities that reflect local conditions, including local preapplication treatment requirements and existing wastewater treatment facilities.

TABLE 5-9
SUGGESTED PREAPPLICATION TREATMENT LEVELS

RI system objective	Preapplication treatment level
Maximize infiltration rates or nitrification	
General case	Primary
Limited land	Secondary
High quality effluent polishing	Secondary or higher
Maximize nitrogen removal	
General case	Primary

5.4 Determination of Hydraulic Loading Rate

Selection of a hydraulic loading rate is the most important and, at the same time, the most difficult step in the design procedure. The loading rate is a function of the site-specific hydraulic capacity, the loading cycle, the quality of the applied wastewater, and the treatment requirements.

5.4.1 Measured Hydraulic Capacity

Hydraulic capacity varies from site to site and is a difficult parameter to measure. For design purposes, infiltration tests are usually used to estimate hydraulic capacity. The most commonly employed measurement for RI design is the basin infiltration test; cylinder infiltrometers are used when basin testing is not feasible. Both methods are described in Section 3.4.

Saturated vertical hydraulic conductivity (also called permeability) is sometimes measured. However, saturated vertical hydraulic conductivity is a constant with time, whereas infiltration rates decrease as wastewater solids clog the soil surface. Thus, vertical conductivity measurements overestimate the wastewater infiltration rates that can be maintained over long periods of time. For this reason, and to allow adequate time for drying periods and for proper basin management, annual hydraulic loading rates should be limited to between 4 and 10% of the measured clear water permeability of the most restrictive soil layer.

Although basin infiltration tests are more accurate than soil hydraulic conductivity measurements and are the preferred method, the small areas usually used allow a larger fraction of the wastewater to flow horizontally through the soil from the test site than from an operating basin. The result is that infiltration rates at the test sites are higher than rates operating systems would achieve. Thus, design annual hydraulic loading rates should be no greater than 10 to 15% of measured basin infiltration rates.

Cylinder infiltrometers greatly overestimate operating infiltration rates. When cylinder infiltrometer measurements are used, annual hydraulic loading rates should be no greater than 2 to 4% of the minimum measured infiltration rates. Annual hydraulic loading rates based on air entry permeameter test results should be in the same range. Annual loading rates and corresponding infiltration rates for several operating RI systems are presented in Table 5-10. Suggested loading rates are summarized in Table 5-11.

TABLE 5-10
TYPICAL HYDRAULIC LOADING RATES FOR RI SYSTEMS [1, 4-9]

Location	(1)	(2)	(3)	(4)		% of (3)
	Operating basin infiltration rate, cm/d	Cylinder infiltrometer rate, cm/d	Vertical hydraulic conductivity, cm/d	m/yr	Annual loading rate cm/d ^a	
Boulder, Colorado	33.6-110	106-290	--	30.5 ^b 48.8 ^b	8.4- 13.4	4- 10
Brookings, South Dakota	41.5	--	--	24- 36 ^b	6.6- 9.9	-- 24
Flushing Meadows, Arizona	60	--	120	122 ^b 60 ^b	33.4 16.4	-- 27
Fort Devens, Massachusetts	62.4	401	--	29 ^c	7.9	13
Hollister, California	17.7	140	--	15.4 ^c	4.2	24
Lake George, New York	>15.2	--	61	43 ^b	11.8	<78
Vineland, New Jersey	--	379	--	21.5 ^c	5.9	--

a. Average annual loading rate divided by 365.

b. Secondary effluent.

c. Primary effluent.

TABLE 5-11
SUGGESTED ANNUAL HYDRAULIC LOADING RATES

Field measurement	Annual loading rate
Basin infiltration test	10-15% of minimum measured infiltration rate
Cylinder infiltrometer and air entry permeameter measurements	2-4% of minimum measured infiltration rate
Vertical hydraulic conductivity measurements	4-10% of conductivity of most restricting soil layer

The total hydraulic load includes both precipitation and wastewater. If the local precipitation is significant, wastewater loading rates should be adjusted accordingly.

Once the hydraulic capacity has been measured, the engineer must calculate an annual hydraulic loading rate. Experience in the United States with treatment systems using RI has been limited to annual loading rates of about 120 m (400 ft) or less.

For example, if the basin test infiltration rate is 3.6 cm/h (1.4 in./h), the annual hydraulic loading rate is calculated to equal:

$$3.6 \text{ cm/h} \times 24 \text{ h/d} \times 365 \text{ d/yr} \times 1 \text{ m/100 cm} \times (0.1 \text{ to } 0.15) \\ = 31.5 \text{ to } 47.3 \text{ m/yr} \text{ (103 to 155 ft/yr)}$$

It is necessary to ensure that BOD and suspended solids are within typical ranges (Sections 2.2.1.1 and 5.2.1) at the calculated annual loading rate. If the applied wastewater contains 150 mg/L BOD and 100 mg/L suspended solids, at a loading rate of 31 m/yr (102 ft/yr), the BOD and SS loadings would average 127 kg/ha·d (114 lb/acre·d) and 85 kg/ha·d (76 lb/acre·d), respectively. These quantities are within the typical BOD range given in Table 2-3 and the suspended solids range discussed in Section 2.2.1.1.

5.4.2 Selection of Hydraulic Loading Cycle and Application Rate

Wastewater application is not continuous in RI, instead, application periods are alternated with drying periods. This improves wastewater treatment efficiency, maximizes long-term infiltration rates, and allows for periodic basin maintenance.

Loading cycles are selected to maximize either the infiltration rate, nitrogen removal, or nitrification. To maximize infiltration rates, the engineer should include drying periods that are long enough for soil reaeration and for drying and oxidation of filtered solids.

Loading cycles used to maximize nitrogen removal vary with the level of preapplication treatment and with the climate and season. In general, application periods must be long enough for soil bacteria to deplete soil oxygen, resulting in anaerobic conditions.

Nitrification requires short application periods followed by longer drying periods. Thus, hydraulic loading cycles used to achieve nitrification are essentially the same as the cycles used to maximize infiltration rates.

Hydraulic loading cycles at selected RI sites are presented in Table 5-12. Recommended cycles are summarized in Table 5-13. Generally, the shorter drying periods shown in Table 5-13 should be used only in mild climates; RI systems in cooler climates should use the longer drying periods. In areas that experience extremely cold weather, even longer drying periods than those presented in Table 5-13 may be necessary. The cycles suggested in Table 5-13 are presented only as guidelines; the actual cycle selected should be suitable and flexible enough for the community's climate, flow, and treatment site characteristics.

Application rates can be calculated from the annual loading rate and the loading cycle. For example, the annual loading rate is 31 m/yr (102 ft/yr) and the loading cycle is 3 days of application followed by 11 days of drying.

- Total cycle time = 3 + 11 = 14 d
- Number of cycles per year = 365/14 = 26
- Loading per cycle = 31/26 = 1.19 m/cycle
- Application rate = (1.19 m/cycle)/(3 d)
= 0.4 m/d

The application rate can then be used to calculate the maximum depth of applied wastewater. For example, if the basin infiltration test rate of 3.6 cm/h (1.4 in./h) is maintained over the 3 day application period, the application rate of 0.4 m/d (1.3 ft/d) should not result in standing water at the end of 3 days:

$$(0.4 \text{ m/d} \times 100 \text{ cm/m}) - (3.6 \text{ cm/h} \times 24 \text{ h/d}) \\ = -46.4 \text{ cm} (-18.3 \text{ in.})$$

TABLE 5-12
TYPICAL HYDRAULIC LOADING CYCLES [6, 9, 18, 19]

Location	Preapplication treatment	Cycle objective	Application period	Resting period	Bed surface
Boulder, Colorado	Trickling filters	Maximize nitrification and infiltration rates	<1 d	<3 1/2 d	Sand (disked), solids turned into soil
Calumet, Michigan	Untreated	Maximize infiltration rates	1-2 d	7-14 d	Sand (not cleaned)
Flushing Meadows, Arizona	Activated sludge				
Year-round		Maximize nitrification	2 d	5 d	Sand (cleaned) ^a
Summer		Maximize infiltration rates	2 wk	10 d	Sand (cleaned) ^a
Winter		Maximize infiltration rates	2 wk	20 d	Sand (cleaned) ^a
Year-round		Maximize nitrogen removal	9 d	12 d	Sand (cleaned) ^a
Fort Devens, Massachusetts	Primary				
Year-round		Maximize infiltration rates	2 d	14 d	Weeds (not cleaned)
Year-round		Maximize nitrogen removal	7 d ^b	14 d	Weeds (not cleaned)
Hollister, California	Primary				
Summer		Maximize infiltration rates	1 d	14-21 d	Sand
Winter		Maximize infiltration rates	1 d	10-16 d	Sand
Lake George, New York	Trickling filters				
Summer		Maximize infiltration rates	9 h	4-5 d	Sand (cleaned) ^a
Winter		Maximize infiltration rates	9 h	5-10 d	Sand (cleaned) ^a
Tel Aviv, Israel	Ponds, lime precipitation, and ammonia stripping	Maximize polishing	5-6 d	10-12 d	Sand ^c
Vineland, New Jersey	Primary	Maximize infiltration rates	1-2 d	7-10 d	Sand (disked) solids turned into soil
Westby, Wisconsin	Trickling filters	Maximize infiltration rates	2 wk	2 wk	Grassed
Whittier Narrows, California	Activated sludge with filtration ^d	Maximize infiltration rates	9 h	15 h	Pea gravel

- a. Cleaning usually involved physical removal of surface solids.
- b. Caused clogging and reduced long-term hydraulic capacity.
- c. Maintenance of sand cover is unknown.
- d. Treated wastewater blended with surface waters before application.

TABLE 5-13
SUGGESTED LOADING CYCLES

Loading cycle objective	Applied wastewater	Season	Application period, d ^a	Drying period, d
Maximize infiltration rates	Primary	Summer	1-2	5-7
		Winter	1-2	7-12
	Secondary	Summer	1-3	4-5
		Winter	1-3	5-10
Maximize nitrogen removal	Primary	Summer	1-2	10-14
		Winter	1-2	12-16
	Secondary	Summer	7-9	10-15
		Winter	9-12	12-16
Maximize nitrification	Primary	Summer	1-2	5-7
		Winter	1-2	7-12
	Secondary	Summer	1-3	4-5
		Winter	1-3	5-10

- a. Regardless of season or cycle objective, application periods for primary effluent should be limited to 1-2 days to prevent excessive soil clogging.

If the calculated depth is a positive number, the maximum design wastewater depth should not exceed 46 cm (18 in.); a maximum depth of 30 cm (12 in.) is preferable because soil clogging and algae growth decrease as the loading depth and detention time decrease. If the calculated depth exceeds 46 cm (18 in.) either the application period must be lengthened or the loading rate decreased. From this example, it is clear that infiltration rates must be determined as accurately as possible. If the infiltration rate is overestimated, basin depth will be underestimated and difficulties will arise when system operation begins.

5.4.3 Other Considerations

The following three subsections describe other factors that can affect the loading cycle and loading rate and must be considered by the designer.

5.4.3.1 Nitrogen Removal

The amount of nitrogen that theoretically (under optimal conditions) can be removed by denitrification can be described by the equation [19].

$$\Delta N = \frac{TOC - K}{2} \quad (5-1)$$

where ΔN = change in total nitrogen concentration, mg/L
TOC = total organic carbon concentration in the applied wastewater, mg/L (see Table 2-1)
K = TOC remaining in percolate, assumed to equal 5 mg/L.

The equation is based on experimental data that indicated 2 grams of wastewater carbon are needed to denitrify 1 gram of wastewater nitrogen [19].

Equation 5-1 can be used to determine whether a wastewater contains enough carbon to remove the desired amount of nitrogen. For example, if the applied wastewater contains 42 mg/L TOC and 25.8 mg/L total nitrogen, it is only possible to remove $(42-5)/2$ mg/L or 18.5 mg/L of nitrogen and to reduce the total nitrogen concentration from 25.8 mg/L to 7.3 mg/L. Thus, using this wastewater, complete nitrogen removal could not be achieved. If the applied wastewater contains 248 mg/L TOC and 40.2 mg/L total nitrogen, there is sufficient carbon to remove 121 mg/L of nitrogen. This means that, theoretically, under proper management, all of the nitrogen could be removed during RI (although total removal might never be achieved in practice). If nitrogen removal is important, the engineer should use Equation 5-1 to determine whether nitrogen removal is feasible using RI. If so, a loading cycle should be selected that maximizes nitrogen removal.

Nitrogen removal from secondary effluent is more difficult than nitrogen removal from a wastewater that contains high concentrations of organic carbon. Nitrogen removal is especially difficult when infiltration rates are high, because nitrates tend to pass through the soil profile before they can be converted to nitrogen gas. In fact, nitrogen removal from secondary effluent increases exponentially as the infiltration rate decreases [20]. This relationship is shown in Figure 5-2.

Although Figure 5-2 is based on data from soil column studies using loamy sand, data from operating systems in warm climates indicate that the figure can be used to obtain conservative estimates of a similar soil's nitrogen removal potential. Thus, if secondary effluent infiltrates at a rate of 30 cm/d (12 in./d), using a loading cycle that promotes nitrogen removal, it should be possible to remove at least 30% of the applied nitrogen. To achieve 80%

nitrogen removal, the soil column studies indicated maximum infiltration rates are:

- 20 cm/d (8 in./d) for primary preapplication treatment
- 15 cm/d (6 in./d) for secondary preapplication treatment

If nitrogen removal is important and these suggested rates are exceeded, soil column studies or pilot testing should be conducted to determine how much nitrogen can be removed. Also, infiltration rates can be reduced somewhat by decreasing the depth of the applied wastewater, or by compacting the soil surface.

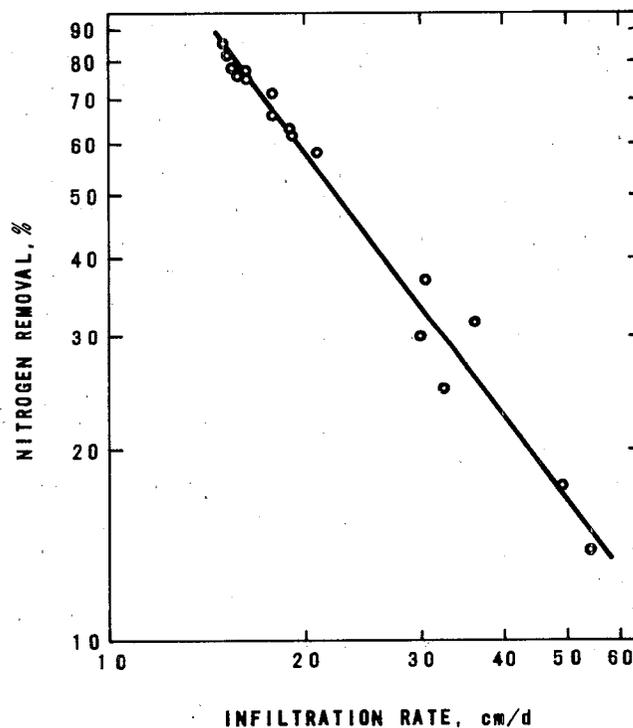

FIGURE 5-2
EFFECT OF INFILTRATION RATE ON NITROGEN REMOVAL [20]

5.4.3.2 Phosphorus Removal

The amount of phosphorus that is removed during RI at neutral pH can be estimated from the following equation [19, 21]:

$$C_x = C_o e^{-kt} \quad (5-2)$$

where C_x = total phosphorus concentration at a distance x along the percolate flow path, mg/L

C_o = total phosphorus concentration in the applied wastewater, mg/L

k = instantaneous rate constant and equals 0.002 h^{-1} at neutral pH

t = detention time = $X\theta/I$, h

where X = distance along the flow path, cm

θ = volumetric water content, cm^3/cm^3 ,
use 0.4

I = infiltration rate during system operation, cm/h (use basin test results, 20% of cylinder infiltration results, or horizontal conductivity for horizontal flow)

Because the minimum phosphorus precipitation rate occurs at neutral pH, this equation can be used to conservatively estimate phosphorus removal. If the calculated phosphorus concentration is an acceptable value, phosphorus concentrations from an operating RI system should be well within limits. However, if the calculated phosphorus concentration at a distance x exceeds acceptable values, a phosphorus adsorption test should be performed. This test measures the ability of a specific soil to remove phosphorus and is described in Section 3.7.2.

For example, consider a site where wastewater percolates through the soil to the ground water table, which is 15 m (49 ft) below the soil surface. The initial phosphorus concentration is 10 mg/L and the basin infiltration test rate is 40 cm/d (16 in./d). By the time the water reaches

the ground water table, the phosphorus concentration should be less than:

$$(10 \text{ mg/L})e^{-0.002h^{-1}\left(\frac{15 \text{ m} \times 0.40}{0.4 \text{ m/d}}\right)\left(\frac{24 \text{ h}}{\text{d}}\right)} = 4.9 \text{ mg/L}$$

If the movement is then predominantly horizontal, with the renovated water seeping into a creek 200 m (650 ft) from the infiltration site, and the horizontal hydraulic conductivity is 120 cm/d (47 in./d), the phosphorus concentration in the seepage should be less than:

$$(4.9 \text{ mg/L})e^{-0.002h^{-1}\left(\frac{200 \text{ m} \times 0.40}{1.2 \text{ m/d}}\right)\left(\frac{24 \text{ h}}{\text{d}}\right)} = 0.2 \text{ mg/L}$$

5.4.3.3 Climate

In regions that experience cold weather, longer loading cycles may be necessary during winter months (Section 5.4.2). Nitrification, denitrification, oxidation (of accumulated organics), and drying rates all decrease during cold weather, particularly as the temperature of the applied wastewater decreases. Longer application periods are needed for denitrification so that the application rate can be reduced as the rate of nitrogen removal decreases. Similarly, longer resting periods are needed to compensate for reduced nitrification and drying rates.

Combined with the reduced hydraulic capacity experienced during cold weather, the need for longer loading cycles changes the allowable wastewater loading rate. Cold weather loading rates are somewhat lower than warm weather rates; therefore, more land is required during cold weather as long as winter and summer wastewater flows are equal. If loading rates must be reduced during cold weather, either the cold weather loading rate should be used to determine land requirements or cold weather storage should be included.

In communities that use ponds as preapplication treatment and experience cold winter weather, winter storage may be required. This is because the temperature of the wastewater becomes quite low prior to land treatment and makes the applied wastewater susceptible to long-term freezing in the basin. Alternatively, RI may be continued through cold weather if warmer wastewater from the first cell of the pond system (if possible) is applied. In such communities, the engineer must keep in mind that the annual loading rate

actually applies only to the portion of the year when RI is used.

5.5 Land Requirements

An RI site must have adequate land for infiltration basins, buffer zones, and access roads. At some systems, land is also needed for preapplication treatment facilities, storage, or future expansion.

5.5.1 Infiltration Basin Area

If wastewater flow equalization is provided (including treatment ponds), the land area required for infiltration only (ignoring land required between and around basins) is simply the average annual wastewater flow divided by the annual wastewater loading rate. For example, if the annual average daily flow is $0.3 \text{ m}^3/\text{s}$ (6.8 Mgal/d) and the wastewater loading rate is 25 m/yr (82 ft/yr), the area required for infiltration is:

$$\frac{(0.3 \text{ m}^3/\text{s})(86,400 \text{ s/d})(365 \text{ d/yr})}{(25 \text{ m/yr})(10^4 \text{ m}^2/\text{ha})} = 37.8 \text{ ha (93.5 acres)}$$

If the wastewater flow varies with season and seasonal flows are not equalized, the highest average seasonal flow should be used. An RI site must either have enough basins so that at least one basin can be dosed at all times or have adequate storage for equalization between application periods.

5.5.2 Preapplication Treatment Facilities

The communities that already have preapplication treatment facilities will, in general, only need additional land for facilities to convey wastewater to the RI site. In communities that are constructing a completely new treatment facility, land requirements for preapplication treatment will vary with the level and method of preapplication treatment.

5.5.3 Other Land Requirements

Additional land may be needed for buffer zones, access roads, storage or flow equalization (when provided), and future expansion. Buffer zones can be used to screen RI sites from public view. Preapplication treatment facilities, access roads, and storage or flow equalization may be included in the buffer area.

Access roads must be provided so that equipment and labor can reach the infiltration basins. Maintenance equipment must be able to enter each basin (for scarification or surface maintenance).

Typically, access roads should be 3 to 3.7 m (10 to 12 ft) wide. In any case, access roads should be wide enough for the selected maintenance equipment and curves should have large enough radii to allow maintenance equipment to turn safely.

Land requirements for flow equalization or storage vary with the type and amount of storage provided. This subject is discussed in greater detail in Section 5.6.2.

5.6 Infiltration System Design

Items that must be addressed during RI system design include wastewater distribution, basin layout and dimensions, basin surfaces, and flow equalization or storage. In areas that experience cold winter weather, cold weather system modifications should also be considered.

5.6.1 Distribution and Basin Layout

Although sprinklers may be used, wastewater distribution is usually by surface spreading. This distribution technique employs gravity flow from piping systems or ditches to flood the application area. To ensure uniform basin application, basin surfaces should be reasonably flat.

Overflow weirs may be used to regulate basin water depth. Water that flows over the weirs is either collected and conveyed to holding ponds for recirculation or distributed to other infiltration basins. If each basin is to receive equal flow, the distribution piping channels should be sized so that hydraulic losses between outlets to basins are insignificant. Design standards for distribution systems and for flow control and measurement techniques are published by the American Society of Agricultural Engineers (ASAE). Outlets used at currently operating systems include valved risers for underground piping systems and turnout gates from distribution ditches. An infiltration basin outlet and splash pad are shown in Figure 5-3. An adjustable weir used as an interbasin transfer structure is shown in Figure 5-4.

Basin layout and dimensions are controlled by topography, distribution system hydraulics, and loading rate. The number of basins is also affected by the selected loading cycle. As a minimum, the system should have enough basins

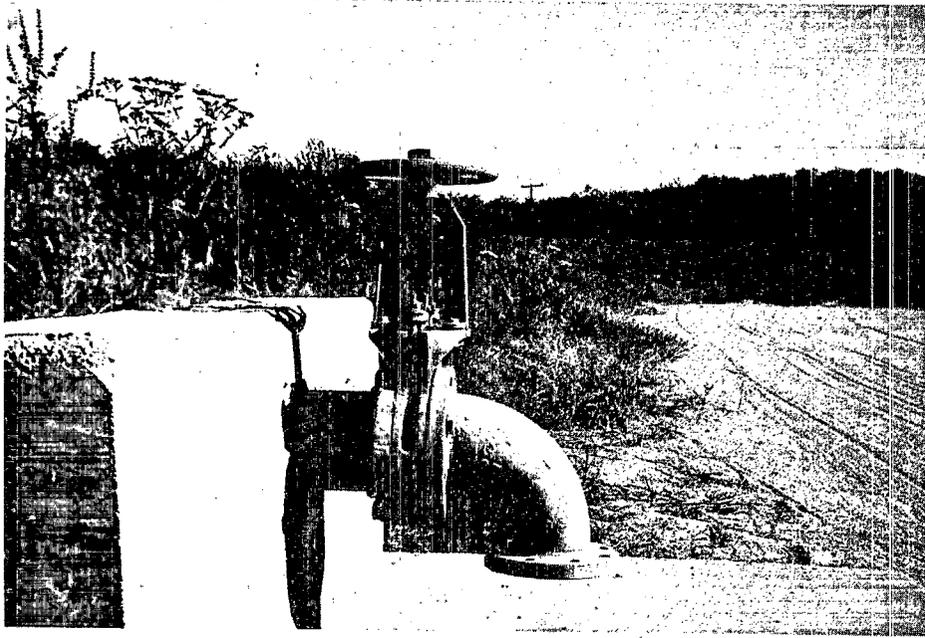

FIGURE 5-3
INFILTRATION BASIN OUTLET AND
SPLASH PAD

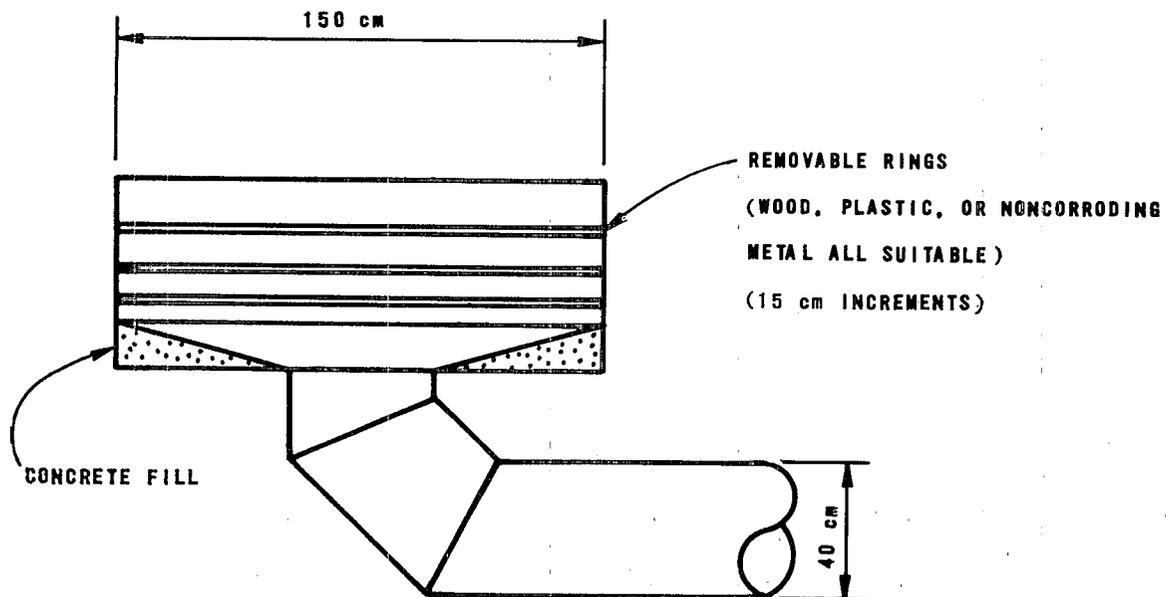

FIGURE 5-4
INTERBASIN TRANSFER STRUCTURE WITH ADJUSTABLE WEIR

so that at least one basin can be loaded at all times, unless storage is provided. The minimum number of basins required for continuous wastewater application is presented as a function of loading cycle in Table 5-14. The engineer should keep in mind that if the minimum number of basins is used, the resulting loading cycle may not be exactly as planned. For example, if the selected loading cycle is 2 application days followed by 6 days of drying and 4 basins are constructed, the resulting loading cycle will be the same as the selected loading cycle. However, if a cycle of 2 days of application followed by 9 days of drying is selected initially and 6 basins are constructed, the resulting loading cycle will actually be 2 days of application followed by 10 days of drying.

TABLE 5-14
MINIMUM NUMBER OF BASINS REQUIRED FOR
CONTINUOUS WASTEWATER APPLICATION

Loading application period, d	Cycle drying period, d	Minimum number of infiltration basins
1	5-7	6-8
2	5-7	4-5
1	7-12	8-13
2	7-12	5-7
1	4-5	5-6
2	4-5	3-4
3	4-5	3
1	5-10	6-11
2	5-10	4-6
3	5-10	3-5
1	10-14	11-15
2	10-14	6-8
1	12-16	13-17
2	12-16	7-9
7	10-15	3-4
8	10-15	3
9	10-15	3
7	12-16	3-4
8	12-16	3
9	12-16	3

The number of basins also depends on the total area required for infiltration. Optimum basin size can range from 0.2 to 2 ha (0.5 to 5 acres) for small to medium sized systems to 2 to 8 ha (5 to 20 acres) for large systems. For a 25 ha (62 acre) system, if the selected loading cycle is 1 day of wastewater application alternated with 10 days of drying, a

typical design would include 22 basins of 1.14 ha (2.8 acres) each. Using 22 basins, 2 basins would be flooded at a time and there would be ample time for basin maintenance before each flooding period.

At many sites, topography makes equal-sized basins impractical. Instead, basin size is limited to what will fit into areas having suitable slope and soil type (Section 2.3.1). Relatively uniform loading rates and loading cycles can be maintained if multiple basins are constructed. However, some sites will require that loading rates or cycles vary with individual basins.

In flat areas, basins should be adjoining and should be square or rectangular to maximize land use. In areas where ground water mounding is a potential problem (Section 5.7.2), less mounding occurs when long, narrow basins with their length normal to the prevailing ground water flow are used than when square or round basins are constructed. Basins should be at least 30 cm (12 in.) deeper than the maximum design wastewater depth, in case initial infiltration is slower than expected and for emergencies. Basin walls are normally compacted soil with slopes ranging from 1:1 to 1:2 (vertical distance to horizontal distance). In areas that experience severe winds or heavy rains, basin walls should be planted with grass or covered with riprap to prevent erosion.

If basin maintenance will be conducted from within the basins, entry ramps should be provided. These ramps are formed of compacted soil at grades of 10 to 20% and are from 3.0 to 3.7 m (10 to 12 ft) wide. Basin surface area for these ramps and for wall slopes should not be considered as part of the necessary infiltration area.

The basin surface may be bare or covered with vegetation. Vegetative covers tend to remove suspended solids by filtration and maintain infiltration rates. However, vegetation also limits the application depth to a value that avoids drowning of vegetation, increases basin maintenance needs, requires an increased application frequency to promote growth, and reduces the soil drying rate. At Lake George, New York, allowing grass to grow in the basins improved the infiltration rate when flooding depths exceeded 0.3 m (1 ft) but decreased the rate at shallower wastewater depths [1]. Gravel covered basins are not recommended. The long-term infiltration capacity of gravel covered basins is lower than the capacity of sand covered basins, because sludge-like solids collect in the voids between gravel particles and because gravel prevents the underlying soil from drying [4].

5.6.2 Storage and Flow Equalization

Although RI systems usually are capable of operating during adverse climatic conditions, storage may be needed to regulate wastewater application rates or for emergencies. Flow equalization may be required if significant daily or seasonal flow peaking occurs. Equalization also may be necessary to store wastewater between application periods, particularly when only one or two infiltration basins are used and drying periods are much longer than application periods.

One example of flow equalization at an RI site occurs at the Milton, Wisconsin, system. Milton discharges secondary effluent to three lagoons. One of these lagoons is used as an infiltration basin; the other two lagoons are used for storage. In this way, Milton is able to maintain a continuous flow into the infiltration basin [3].

In contrast, the City of Hollister formerly equalized flow with an earthen reservoir that was ahead of the treatment plant headworks. In addition, one infiltration basin was kept in reserve for primary effluent during periods when wastewater flows were excessive [6].

Winter storage may be needed if the soil permeability is on the low end for RI. In such cases, the water may not drain from the profile fast enough to avoid freezing.

5.6.3 Cold Weather Modifications

Rapid infiltration systems that operate successfully during cold winter weather without any cold weather modifications can be found in Victor, Montana; Calumet, Michigan; and Fort Devens, Massachusetts. However, a few different basin modifications have been used to improve cold weather treatment in other communities. First, basin surfaces that are covered with grass or weeds should be mowed during fall. Mowing followed by disking should prevent ice from freezing to vegetation near the soil surface. Floating ice helps insulate the applied wastewater, whereas ice that freezes at the soil surface prevents infiltration. Problems with ice freezing to vegetation have been reported at Brookings, South Dakota, where basins were not mowed and ponds are used for preapplication treatment [7].

Another cold weather modification involves digging a ridge and furrow system in the basin surface. Following wastewater application, ice forms on the surface of the water and forms bridges between the ridges as the water level drops. Subsequent loadings are applied beneath the

surface of the ice, which insulates the wastewater and the soil surface. For bridging to occur, a thick layer of ice must form before the wastewater surface drops below the top of the ridges. This modification has been used successfully in Boulder, Colorado, and Westby, Wisconsin.

The third type of basin modification involves the use of snow fencing or other materials to keep a snow cover over the infiltration basins. The snow insulates both applied wastewater and soil.

5.7 Drainage

Rapid infiltration systems require adequate drainage to maintain infiltration rates and treatment efficiencies. The infiltration rate may be limited by the horizontal hydraulic conductivity of the underlying aquifer. Also, if there is insufficient drainage, the soil will remain saturated with water and reaeration will be inadequate for oxidation of ammonia nitrogen to occur.

Renovated water may be isolated to protect either or both the ground water or the renovated water. In both cases, there must be some method of engineered drainage to keep renovated water from mixing with native ground water.

Natural drainage often involves subsurface flow to surface waters. If water rights are important, the engineer must determine whether the renovated water will drain to the correct watershed or whether wells or underdrains will be needed to convey the renovated water to the required surface water. In all cases, the engineer needs to determine the direction of subsurface flow due to drainage from RI basins.

5.7.1 Subsurface Drainage to Surface Waters

If natural subsurface drainage to surface water is planned, soil characteristics can be analyzed to determine if the renovated water will flow from the recharge site to the surface water. For subsurface discharge to a surface water to occur, the width of the infiltration area must be limited to values equal to or less than the width calculated in the following equation [22]:

$$W = KDH/dL \quad (5-3)$$

where W = total width of infiltration area in direction of ground water flow, m (ft)

- K = permeability of aquifer in direction of groundwater flow, m/d (ft/d)
- D = average thickness of aquifer below the water table and perpendicular to the direction of flow, m (ft)
- H = elevation difference between the water level of the water course and the maximum allowable water table below the spreading area, m (ft)
- d = lateral flow distance from infiltration area to surface water, m (ft)
- L = annual hydraulic loading rate (expressed as daily rate), m/d (ft/d)

Examples of these parameters are shown in Figure 5-5.

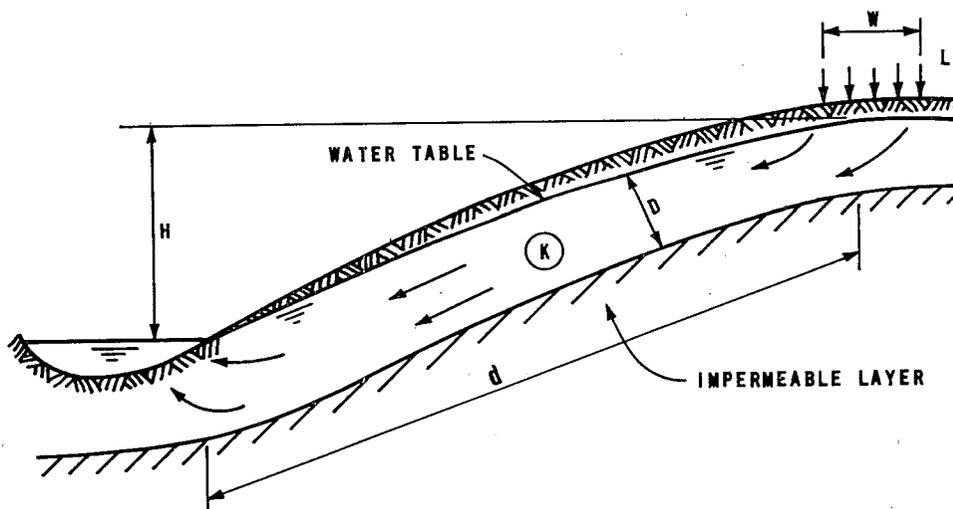

FIGURE 5-5
NATURAL DRAINAGE OF RENOVATED WATER
INTO SURFACE WATER [22]

As an example, consider an infiltration site located above an aquifer whose permeability is 1.1 m/d (3.6 ft/d) and whose average thickness is 9 m (30 ft). The annual hydraulic loading rate is 30 m/yr or 0.082 m/d (98 ft/yr or 0.27 ft/d). The surface water elevation is 6 m (20 ft) below the infiltration site, and the water table should remain at least 1.5 m (5 ft) below the soil surface. The infiltration site is 25 m (82 ft) from the surface water. Thus,

$$W = \frac{(1.1 \text{ m/d})(9 \text{ m})(6 \text{ m} - 1.5 \text{ m})}{(25 \text{ m})(0.082 \text{ m/d})} = 22 \text{ m (72 ft)}$$

Under these conditions, either a single basin 22 m (72 ft) wide or multiple basins having a combined width of 22 m could be constructed. If more infiltration area is needed, additional basins could be built in the two directions perpendicular to the direction of ground water flow. Four basins oriented in this manner are illustrated in Figure 5-6.

If the calculated width is quite small (less than about 10 m or 33 ft), natural subsurface drainage to surface waters is not feasible and engineered drainage should be provided.

5.7.2 Ground Water Mounding

During RI, the applied wastewater travels initially downward to the ground water, resulting in a temporary ground water mound beneath the infiltration site. This condition is shown schematically in Figure 5-7. Mounds continue to rise during the flooding period and only recede during the resting period.

Excessive mounding will inhibit infiltration and reduce the effectiveness of treatment. For this reason, the capillary fringe above the ground water mound should never be closer than 0.6 m (2 ft) to the bottom of the infiltration basin [23]. This distance corresponds to a water table depth of about 1 to 2 m (3 to 7 ft), depending on the soil texture. The distance to ground water should be 1.5 to 3 m (5 to 10 ft) below the soil surface within 2 to 3 days following a wastewater application. The following paragraphs describe an analysis that can be used to estimate the mound height that will occur at various loading conditions. This method can be used to estimate whether a site has adequate natural drainage or whether mounding will exceed the recommended values without constructed drainage.

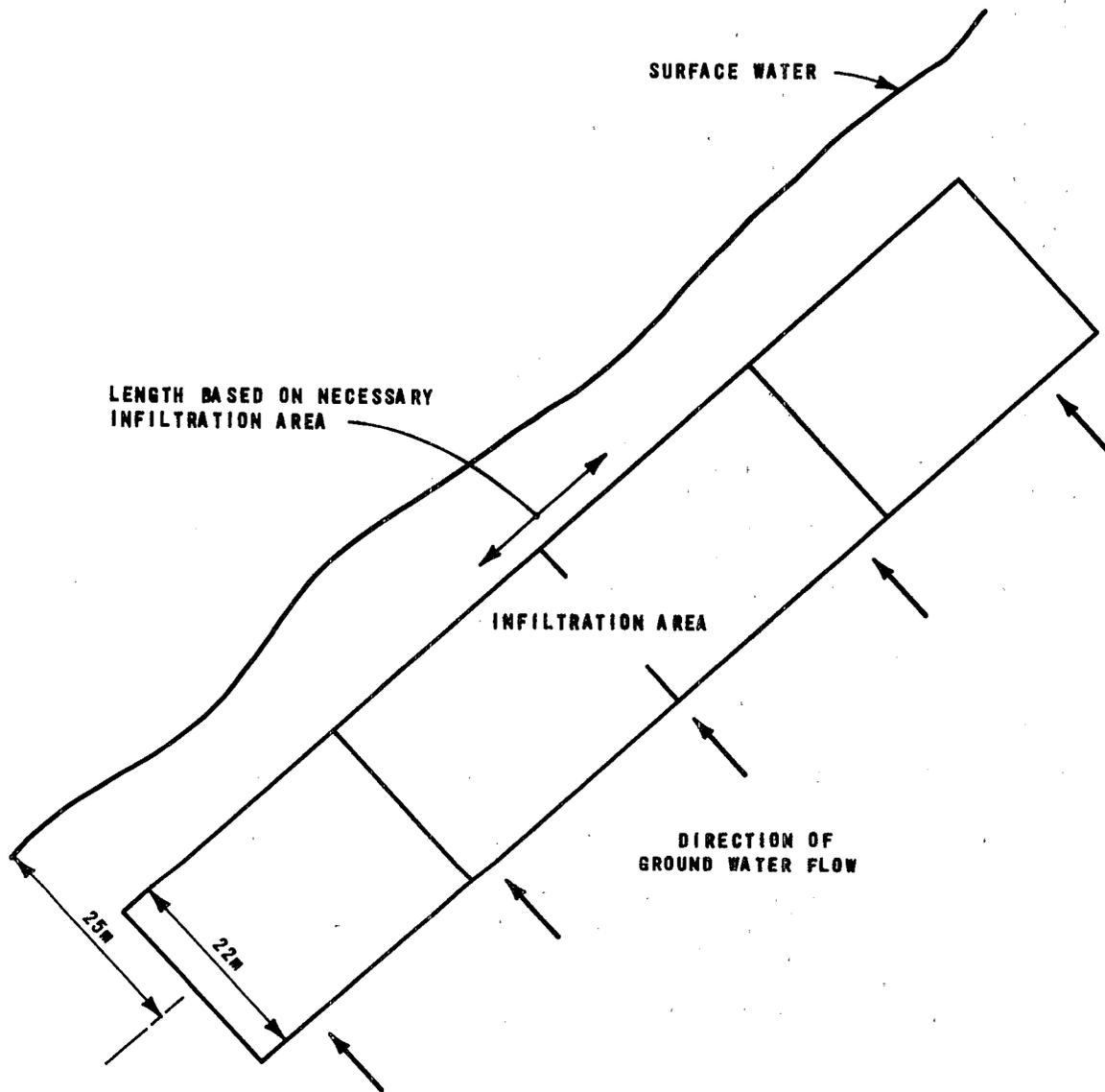

FIGURE 5-6
EXAMPLE DESIGN FOR SUBSURFACE FLOW TO SURFACE WATER

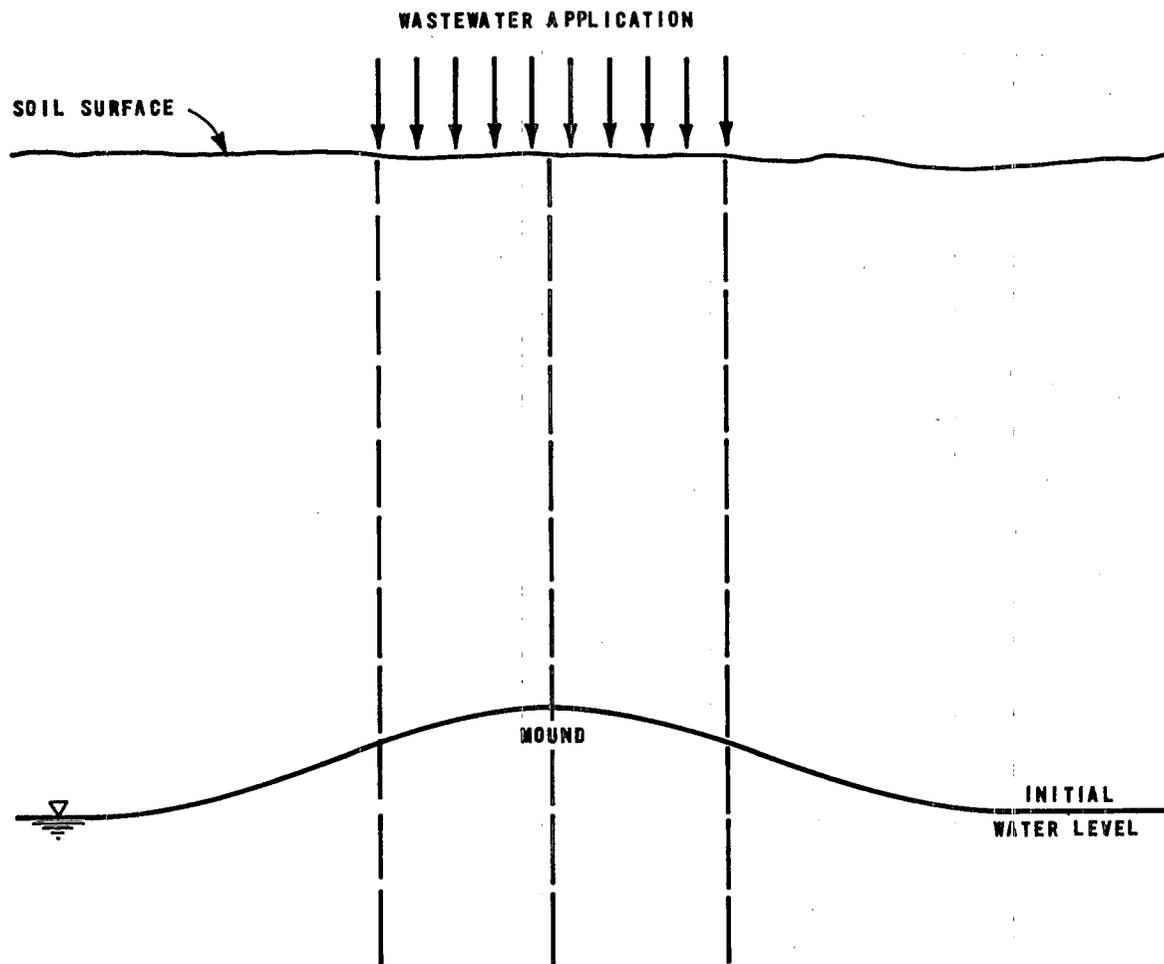

FIGURE 5-7
SCHEMATIC OF GROUND WATER MOUND

Ground water mounding can be estimated by applying heat-flow theory and the Dupuit-Forchheimer assumptions [24]. These assumptions are as follows:

1. Flow within ground water occurs along horizontal flow lines whose velocity is independent of depth.
2. The velocity along these horizontal streamlines is proportional to the slope of the free water surface.

Using these assumptions, heat-flow theory has been successfully compared to actual ground water depths at several existing RI sites.

To compute the height at the center of the ground water mound, one must calculate the values of $W/\sqrt{4\alpha t}$ and Rt ,

where W = width of the recharge basin, m (ft)

$$\alpha = KD/V, \text{ m}^2/\text{d} \text{ (ft}^2/\text{d)}$$

where K = aquifer (horizontal) hydraulic conductivity, m/d (ft/d)

D = saturated thickness of the aquifer, m (ft)

V = specific yield or fillable pore space of the soil, m^3/m^3 (ft^3/ft^3)
(Figures 3-5 and 3-6)

t = length of wastewater application, d

$$R = I/V, \text{ m/d} \text{ (ft/d)}$$

where I = infiltration rate or volume of water per unit area of soil surface, $\text{m}^3\text{H}_2\text{O}/\text{m}^2\cdot\text{d}$
($\text{ft}^3\text{H}_2\text{O}/\text{ft}^2\cdot\text{d}$)

The parameters that can be shown schematically are illustrated in Figure 5-5.

Once the value of $W/\sqrt{4\alpha t}$ is obtained, one can use dimensionless plots of $W/\sqrt{4\alpha t}$ versus h_0/Rt , provided as Figures 5-8 (for square recharge areas) and 5-9 (for rectangular recharge areas), to obtain the value of h_0/Rt , where h_0 is the rise at the center of the mound. Using the calculated value of Rt , one can solve for h_0 .

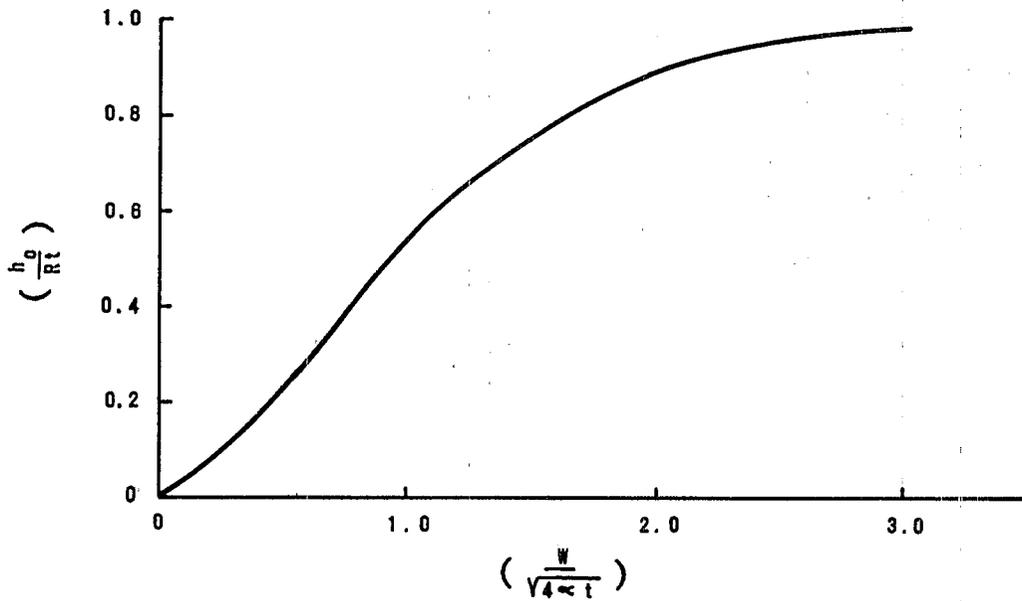

FIGURE 5-8
MOUNDING CURVE FOR CENTER OF A SQUARE
RECHARGE AREA [24]

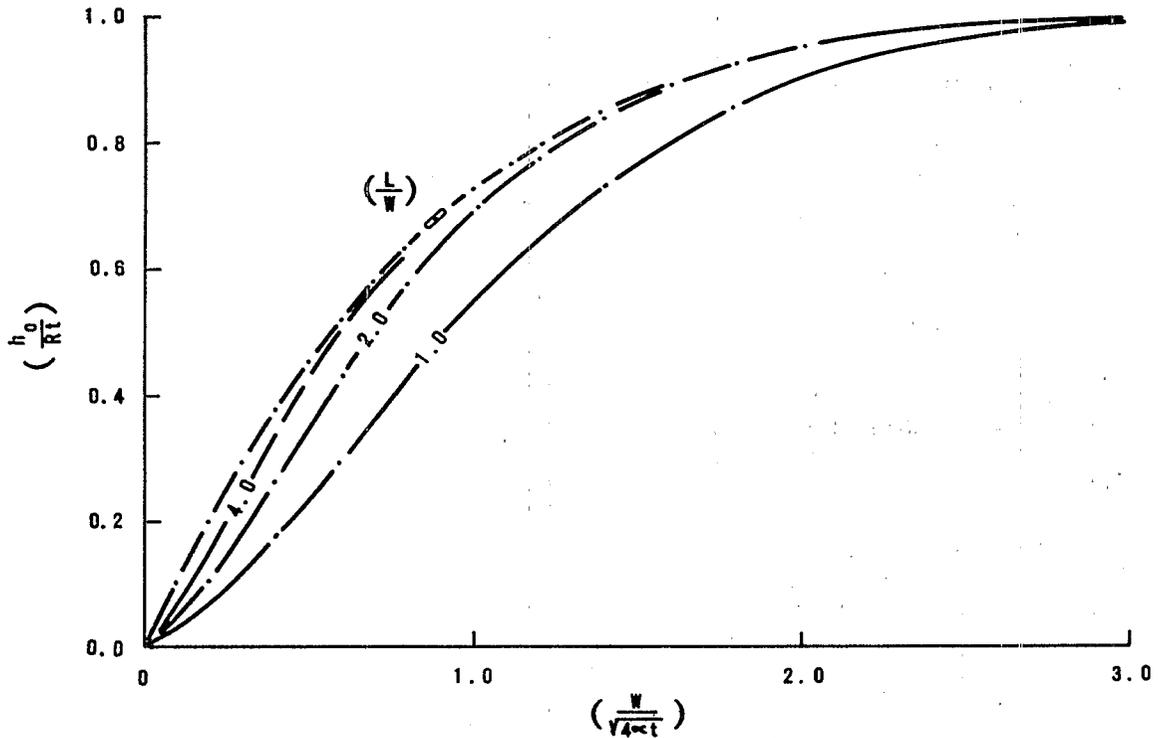

FIGURE 5-9
MOUNDING CURVE FOR CENTER OF A RECTANGULAR RECHARGE AREA AT
DIFFERENT RATIOS OF LENGTH (L) TO WIDTH (W) [24]

For example, an RI system is planned above an aquifer that is 4 m (13 ft) thick. Auger hole measurements (Section 3.6.2.1) have indicated that the hydraulic conductivity is $(5 \text{ m}^3/\text{d})/4 \text{ m}$ or 1.25 m/d (4.1 ft/d). Using Figure 3-6 with this hydraulic conductivity, the specific yield is 15%. The basins are to be 12 m (39 ft) wide and square; the basin infiltration rate is 0.20 m/d (7.9 in./d); and the application period will be 1 day long. Using these data, the following calculations are performed.

$$\alpha = \frac{(1.25 \text{ m/d})(4 \text{ m})}{0.15}$$

$$= 33.3 \text{ m}^2/\text{d} \text{ (360 ft}^2/\text{d)}$$

$$R = \frac{0.20 \text{ m/d}}{0.15}$$

$$= 1.3 \text{ m/d} \text{ (4.3 ft/d)}$$

$$Rt = (1.3 \text{ m/d})(1 \text{ d})$$

$$= 1.3 \text{ m} \text{ (4.3 ft)}$$

$$W/\sqrt{4\alpha t} = \frac{12 \text{ m}}{[4(33.3 \text{ m}^2/\text{d})(1 \text{ d})]^{1/2}}$$

$$= 1.0$$

Using Figure 5-8, h_o/Rt equals 0.53.

Thus, h_o equals $(0.53)(1.3 \text{ m})$ or 0.7 m (2.3 ft). If the initial ground water depth is 6.0 m (20 ft), the depth after wastewater application is still 5.3 m (17 ft) and engineered drainage is unnecessary. Should the calculations indicate that the ground water table will rise to within less than 1 to 2 m (3.3 to 6.6 ft) below the basin, additional drainage will be needed.

Figures 5-10 (for square recharge areas) and 5-11 (for recharge areas that are twice as long as they are wide) can be used to estimate the depth to the mound at various distances from the center of the recharge basin. Again the values of $W/\sqrt{4\alpha t}$ and Rt must be determined first. Then, for a given value of x/W , where x equals the horizontal distance from the center of the recharge basin, one can obtain the value of h_o/Rt from the correct plot. Multiplying this number by the calculated value of Rt results in the rise of the mound, h_o , at a distance x from the center of the recharge site. The depth to the mound from the soil surface is simply the difference between the distance to the ground water before recharge and the rise due to the mound.

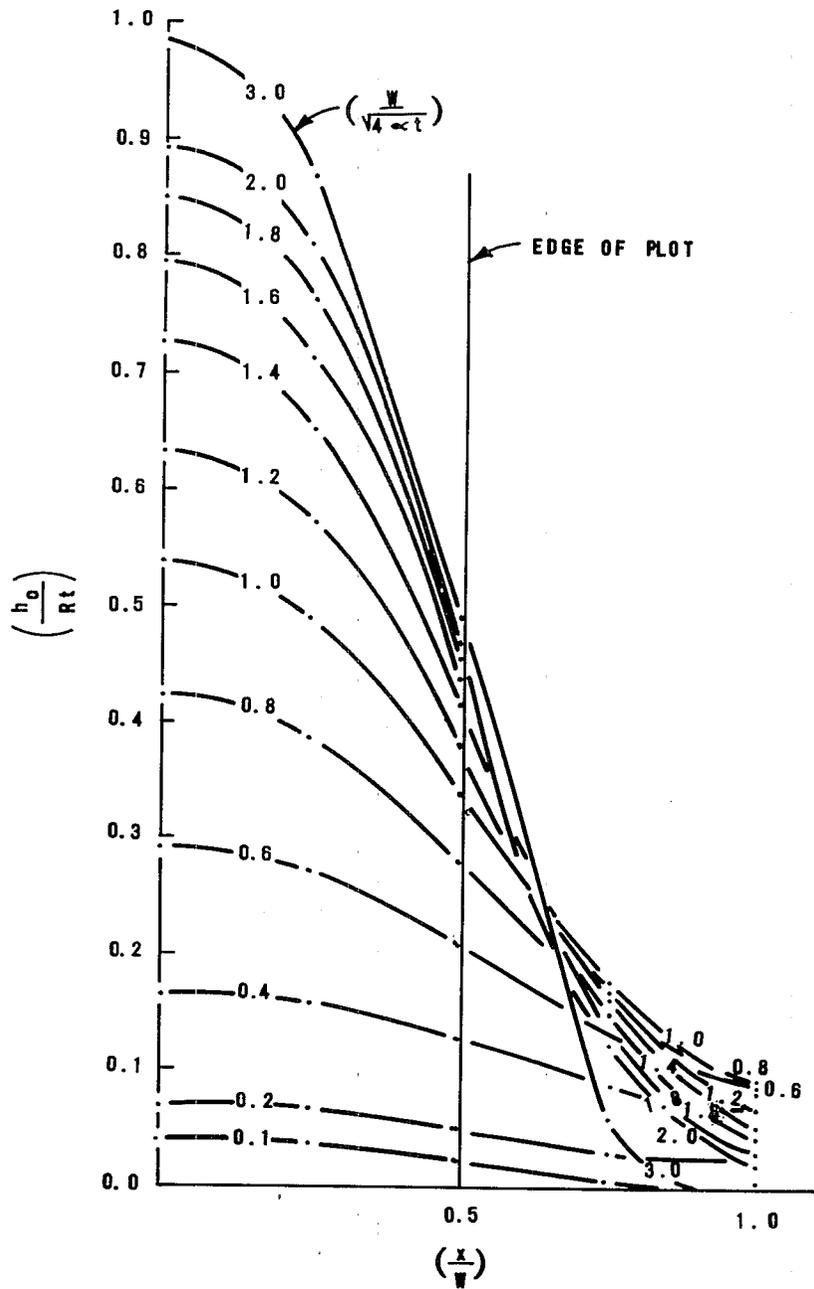

FIGURE 5-10
 RISE AND HORIZONTAL SPREAD OF MOUND BELOW
 A SQUARE RECHARGE AREA [24]

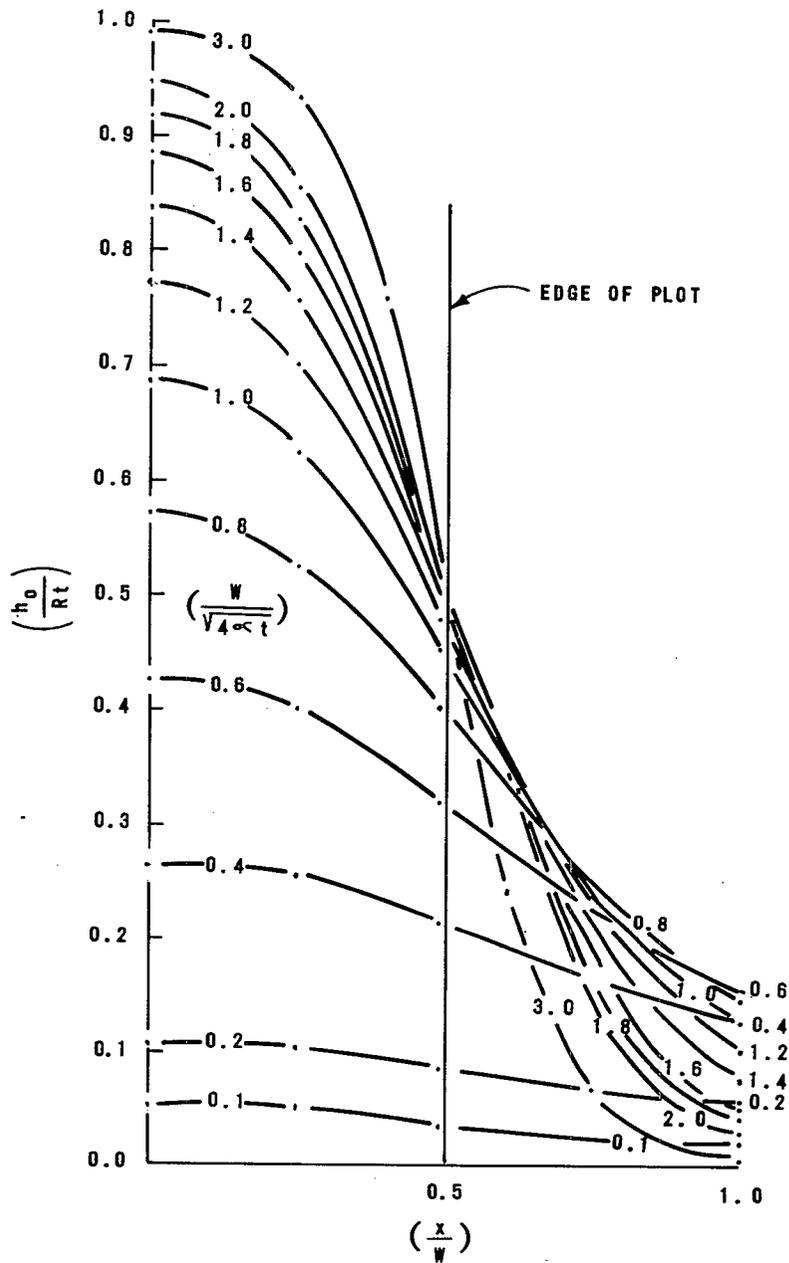

FIGURE 5-11
 RISE AND HORIZONTAL SPREAD OF MOUND BELOW A
 RECTANGULAR RECHARGE AREA WHOSE LENGTH
 IS TWICE ITS WIDTH [24]

To evaluate mounding beneath adjacent basins, Figures 5-10 and 5-11 should be used to plot ground water table mounds as functions of distance from the center of the plot and time elapsed since initiation of wastewater application. Then, critical mounding times should be determined, such as when adjacent or relatively close basins are being flooded, and the mounding curves of each basin at these times should be superimposed. At sites where drainage is critical because of severe land limitations or extremely high ground water tables, the engineer should use the approach described in reference [25] to evaluate mounding.

In areas where both the water table and the impermeable layer underneath the aquifer are relatively close to the soil surface, it may be possible to avoid the complicated mounding analysis by using the following procedure:

1. Assume underdrains are needed and calculate the underdrain spacing (Section 5.7.3).
2. If the calculated underdrain spacing is relatively narrow, between 15 and 50 m (50 and 160 ft), underdrains will be required and there is no need to verify that the mound will reach the soil surface.
3. If the calculated spacing is less than about 10 m (30 ft), the loading rate may have to be reduced for the project to be economically feasible.
4. If the calculated spacing is greater than about 50 m (160 ft), mounding should be evaluated to determine if any underdrains will be necessary.

This procedure is not appropriate for unconfined or relatively deep aquifers. For such aquifers, mounding should always be evaluated.

5.7.3 Underdrains

For RI systems located in areas where both the water table and the impermeable layer underneath the aquifer are relatively close to the soil surface, renovated water can be collected by open or closed drains. In such areas, when drains can be installed at depths of 5 m (16 ft) or less, underdrains are more effective and less costly than wells for removing renovated water from the aquifer. Horizontal drains have been used to collect renovated river water from RI systems in western Holland, where polluted Rhine water is treated, and at Dortmund, Germany, where water from the Ruhr

River is pretreated for a municipal water supply [23]. At Santee, California, an open ditch was used to intercept reclaimed water [23].

Rapid infiltration systems using underdrains may consist of two parallel infiltration strips with a drain midway between the strips or a series of strips and drains. These two types of configurations are shown in Figures 5-12 and 5-13. In the first system, the drains are left open at all times during the loading cycle. If the second system is used, the drains below the strips receiving wastewater are closed and renovated water is collected from drains beneath the resting strips. When infiltration beds are rotated, the drains that were closed before are opened and those that were open are closed. This procedure allows maximum underground detention times and travel distance.

To determine drain placement, the following equation is useful [27]:

$$S = \left[\frac{4KH}{L_w + P} (2d + H) \right]^{1/2} \quad (5-4)$$

where S = drain spacing, m (ft)

K = horizontal hydraulic conductivity of the soil,
m/d (ft/d)

H = height of the ground water mound above the drains,
m (ft)

L_w = annual wastewater loading rate, expressed as a
daily rate, m/d (ft/d)

P = average annual precipitation rate, expressed as a
daily rate, m/d (ft/d)

d = distance from drains to underlying impermeable
layer, m (ft)

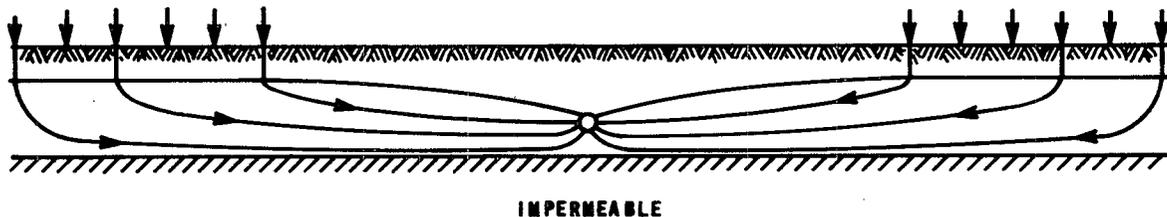

FIGURE 5-12
CENTRALLY LOCATED UNDERDRAIN [26]

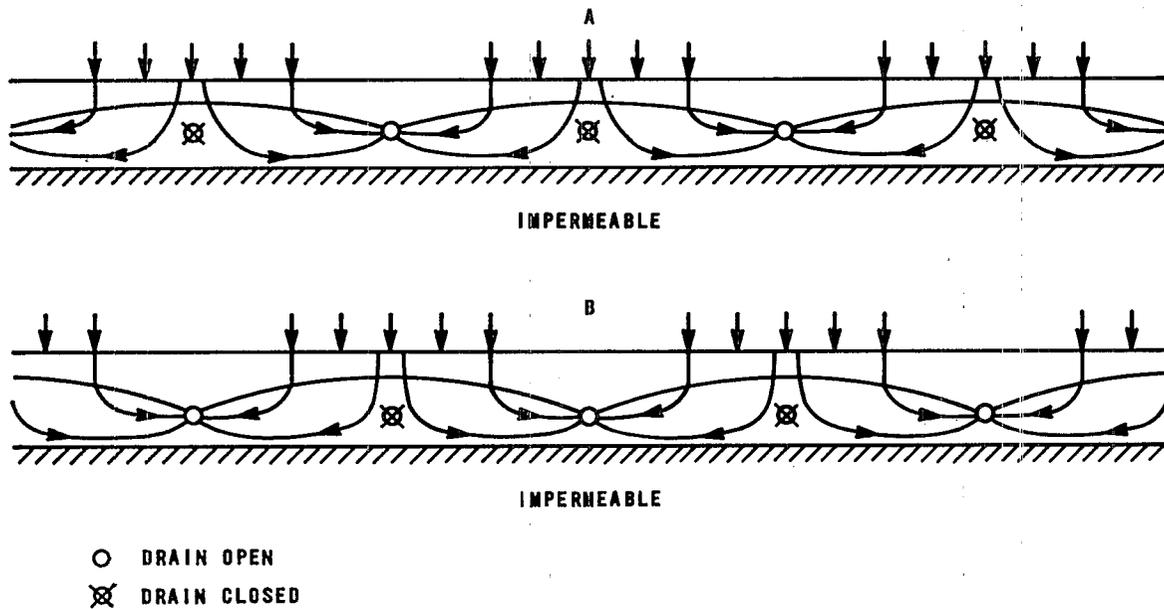

FIGURE 5-13
UNDERDRAIN SYSTEM USING ALTERNATING
INFILTRATION AND DRYING STRIPS [26]

For clarification, these parameters are shown in Figure 5-14. When L , P , K , and the maximum acceptable value of H are known, this equation can be used to determine S for various values of d . For example, consider an RI system loaded at an average rate of 44 m/yr or 0.12 m/d (144 ft/yr or 0.40 ft/d). Using Equation 5-4, the drain spacing can be calculated using the following data:

$$K = 12 \text{ m/d (39 ft/d)}$$

$$H = 1 \text{ m (3.28 ft)}$$

$$d = 0.6 \text{ m (2 ft)}$$

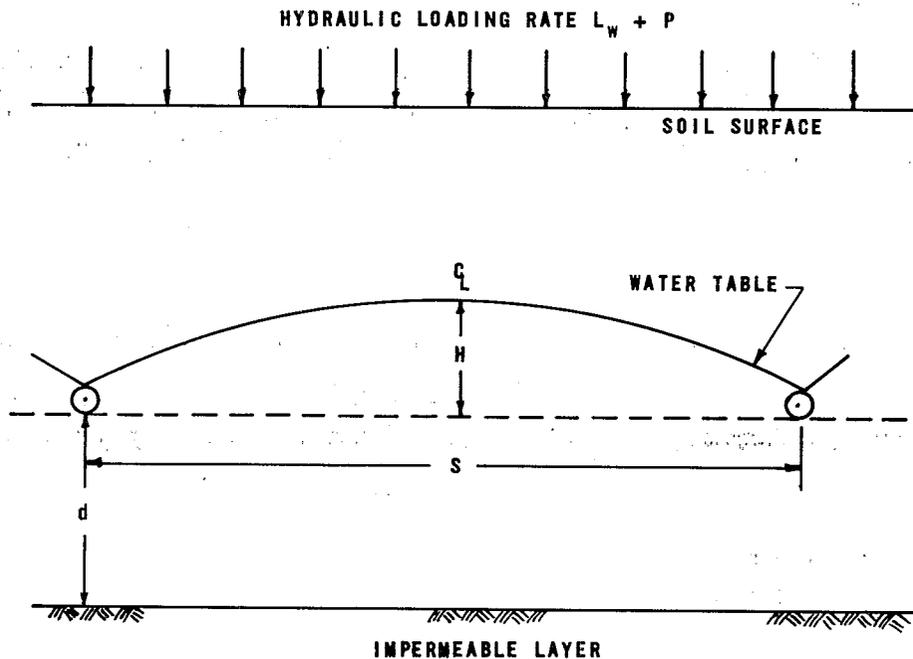

FIGURE 5-14
PARAMETERS USED IN DRAIN DESIGN [26]

The application rate must include precipitation as well as wastewater. Therefore, a design storm of 0.03 m/d (0.10 ft/d) is added to the 0.12 m/d (0.40 ft/d) wastewater load for a total of 0.15 m/d (0.50 ft/d). The drain spacing is calculated as:

$$\begin{aligned}
 S^2 &= [4KH/(L_w + P)](2d + H) \\
 &= \frac{4(12 \text{ m/d})(1 \text{ m})}{0.12 \text{ m/d} + 0.03 \text{ m/d}} [2(0.6 \text{ m}) + 1 \text{ m}] \\
 &= 704 \text{ m}^2
 \end{aligned}$$

$$S = 26 \text{ m (85 ft)}$$

Generally, drains are spaced 15 m (50 ft) or more apart and are at depths of 2.5 to 5.0 m (8 to 16 ft). In soils with high lateral permeability, spacing may approach 150 m (500 ft). Although closer drain spacing allows more control over the depth of the ground water table, as drain spacing decreases the cost of providing underdrains increases. When designing a drainage system, different values of d should be

selected and used to calculate S, so that the optimum combination of d, H, and S can be determined. Detailed information on drainage may be found in the U.S. Bureau of Reclamation Drainage Manual [28] and in the American Society of Agronomy manual, Drainage for Agriculture [29].

Once the drain spacing has been calculated, drain sizing should be determined. Usually, 15 or 20 cm (6 in. or 8 in.) drainage laterals are used. The laterals connect to a collector main that must be sized to convey the expected drainage flows. Drainage laterals should be placed so that they will be free flowing; the engineer should check drainage hydraulics to determine necessary drain slopes.

5.7.4 Wells

Rapid infiltration systems that utilize unconfined and relatively deep aquifers should use wells to improve drainage or to remove renovated water. Wells are used to collect renovated water directly from the RI sites at both Phoenix, Arizona, and Fresno, California. Wells are also involved in the reuse of recharged wastewater at Whittier Narrows, California; however, the wells pump ground water that happens to contain reclaimed water, rather than pumping specifically for renovated water.

The arrangement of wells and recharge areas varies; wells may be located midway between two recharge areas, may be placed on either side of a single recharge strip, or may surround a central infiltration area. These three configurations are illustrated in Figure 5-15. Well design is beyond the scope of this manual but is described in detail in reference [30].

5.8 Monitoring and Maintenance Requirements

The purpose of discussing monitoring and maintenance requirements is to enable the engineer to determine labor and equipment needs. The engineer must know these needs to complete a thorough cost estimate and to ensure that the necessary labor and equipment are available.

5.8.1 Monitoring

There are two distinct reasons for monitoring RI systems:

1. To document that the system meets any requirements established by appropriate regulatory agencies and to confirm that the design provides adequate treatment

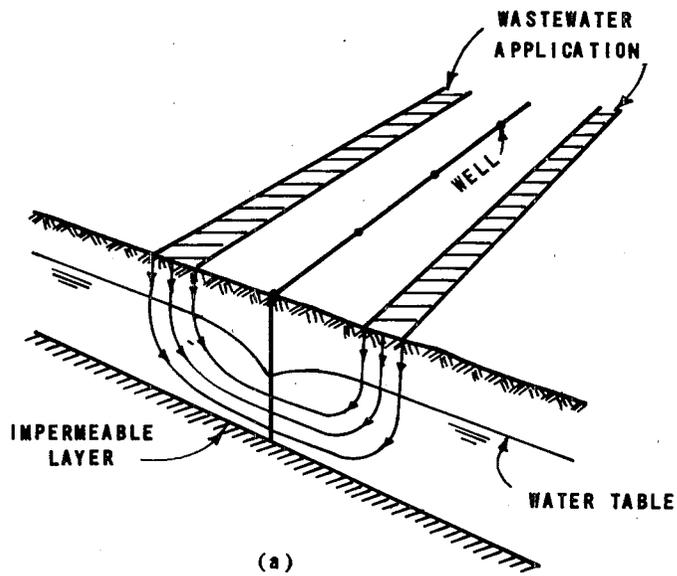

a. WELLS MIDWAY BETWEEN TWO APPLICATION STRIPS

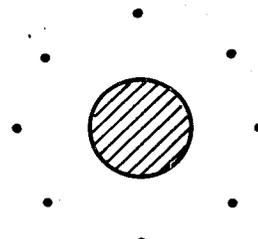
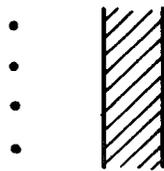

b. and c. WELLS (DOTS) SURROUNDING APPLICATION AREAS (HATCHED AREAS)

FIGURE 5-15
WELL CONFIGURATIONS [26]

2. To provide data needed to make management decisions

A monitoring program may include measurements of ground water quality, soil characteristics applied water quality, and, when appropriate, the quality of water removed from the aquifer for reuse. Representative measurements of ground water quality are difficult to obtain. Because constituent movement is slower than in surface water, a ground water sample can contain contributions from several years past that do not accurately reflect treatment occurring at the RI site. For this reason, it is important to place sampling wells in positions that minimize the time period between wastewater application and appearance of wastewater constituents in the observation wells. Techniques for monitoring well design and sampling procedures are included in references [31, 32]. Guidance in determining what parameters and site conditions to monitor can be obtained from federal, state, and local agencies.

Although soil monitoring is not required at many sites, it is periodically desirable. Below pH 6.5, soil retention of metals decreases substantially and the possibility of ground water contamination by heavy metals increases. Potential soil permeability problems may be indicated by either a high pH (above 8.5) or a high percent of sodium on the soil exchange complex (over 10 to 15%). High soil pH can indicate a high sodium content. This condition may be corrected by displacing the sodium with soluble calcium.

Both applied wastewater and any renovated water collected from the aquifer for reuse or discharge should be monitored. Applied wastewater analyses are necessary for process control to ensure that the design hydraulic loading is maintained. Renovated water that is recovered for any purpose must meet whatever water quality criteria have been established for those purposes.

5.8.2 Maintenance

Basic maintenance requirements are as follows:

- Periodic scarification or scraping of RI basin surfaces
- Periodic mowing of vegetated surfaces

As a result of bacterial activity and solids deposition, a mat forms on the surfaces of infiltration areas and reduces infiltration rates. Furthermore, wastewater applications may cause classification of the underlying soils, allowing

the fines to migrate to the top and to seal the soil surface. Periodically, basin surfaces must be scarified (raked, harrowed, or disked) to break up the mat and loosen the soil surface. Alternatively, the mat may be scraped from the soil surface with a front-end loader [4] and landfilled or buried. These operations should be performed whenever regular drying fails to restore infiltration rates to acceptable levels. If scraping alone does not restore the initial infiltration rate, the soil surface should be loosened by disking or harrowing. Basin surfaces may be scarified following each drying period if time, labor, and equipment are available; basin scarification or scraping should be done at least once every 6 months to 1 year.

If grasses or other vegetation are grown on basin surfaces, the vegetation can be allowed to grow and die without maintenance. Heavy mechanical equipment that would compact the soil surface should not be operated on the infiltration basins. For aesthetic reasons, periodic mowing of the grass or harrowing of the soil surface may be desirable. In cold weather climates, vegetation should be mowed during late October or early November to prevent ice chunks from freezing to the vegetation and thereby cooling the applied wastewater.

5.9 Design and Construction Guidance

Some specific items that are unique to RI design and construction should be considered:

- Underdrains will operate only in saturated soil. If the water table does not rise, or is not already at the elevation of the drains, they will not recover any water.
- A filter sock can be used in place of a gravel envelope around plastic drain pipe in sandy soil. The filter sock will clog, however, with fines if used alone in silty clay soils.
- RI basins, when constructed, should be ripped to alleviate traffic compaction. After ripping, the surface should be smoothed and leveled, but never compacted.
- If soils at the RI site contain varying percentages of clay or silt, the heavier soils should be segregated and used for berms. Berms should be compacted, but infiltration surfaces should not be compacted.

5.10 References

1. Aulenbach, D.B. Long Term Recharge of Trickling Filter Effluent into Sand. U.S. Environmental Protection Agency. EPA-600/2-79-068. March 1979.
2. Baillod, C.R., et al. Preliminary Evaluation of 88 Years of Rapid Infiltration of Raw Municipal Sewage at Calumet, Michigan. In: Land as a Waste Management Alternative. Ann Arbor Science. 1977.
3. Benham-Blair & Affiliates, Inc., and Engineering Enterprises, Inc. Long-term Effects of Land Application of Domestic Wastewater: Milton, Wisconsin, Rapid Infiltration Site. U.S. Environmental Protection Agency. EPA-600/2-79-145. August 1979.
4. Bower, H., et al. Rapid-Infiltration Research at Flushing Meadows Project, Arizona. Journal Water Pollution Control Federation. 52(10):2457-2470. 1980.
5. Koerner, E.T., and D.A. Haws. Long-Term Effects of Land Application of Domestic Wastewater: Vineland, New Jersey Rapid Infiltration Site. U.S. Environmental Protection Agency. EPA-600/2-79-072. March 1979.
6. Pound, C.E., R.W. Crites, and J.V. Olson. Long-Term Effects of Land Application of Domestic Wastewater - Hollister, California, Rapid Infiltration Site. U.S. Environmental Protection Agency. EPA-600/2-78-084. April 1978.
7. Dornbush, J.N. Infiltration Land Treatment of Stabilization Pond Effluent. Technical Progress Report 3. South Dakota State University, Brookings, South Dakota. April 1978.
8. Satterwhite, M.B., B.J. Condike, and G.L. Stewart. Treatment of Primary Sewage Effluent by Rapid Infiltration. U.S. Army Corps of Engineers, Cold Regions Research and Engineering Laboratory. December 1976.
9. Smith, D.G., K.D. Linstedt, and E.R. Bennett. Treatment of Secondary Effluent by Infiltration-Percolation. U.S. Environmental Protection Agency. EPA-600/2-79-174. August 1979.
10. Broadbent, F.E., K.B. Tyler, and G.N. Hill. Nitrification of Ammonical Fertilizers in Some California Soils. Hilgardia. 27:247-267. 1957.

11. Vaccaro, R.F., et al. Wastewater Renovation and Retrieval at Cape Cod. U.S. Environmental Protection Agency. EPA-600/2-79-176. August 1979.
12. Merrell, J.C., Jr., et al. The Santee Recreation Project: Santee, California (Final Report). U.S. Department of the Interior, Federal Water Pollution Control Administration, Water Pollution Control Research Series Publication No. WP-20-7. 1967.
13. Lance, J.C., C.P. Gerba, and J.L. Melnick. Virus Movement in Soil Columns Flooded with Secondary Sewage Effluent. Applied and Environmental Microbiology. 32:520-526. 1976.
14. Gerba, C.P. and J.C. Lance. Poliovirus Removal from Primary and Secondary Sewage Effluent by Soil Filtration. Applied and Environmental Microbiology. 36:247-251. 1978.
15. Gilbert, R.G., et al. Virus and Bacteria Removal from Wastewater by Land Treatment. Applied and Environmental Microbiology. 32(3):333. 1976.
16. Gerba, C.P. and J.C. Lance. Pathogen Removal from Wastewater During Groundwater Recharge. In: Proceedings of Symposium on Wastewater Reuse for Groundwater Recharge, Pomona, California. September 6-7, 1979.
17. U.S. Environmental Protection Agency. Facilities Planning, 1982. EPA-430/9-81-012. FRD-25. September 1981.
18. Pound, C.E., and R.W. Crites. Wastewater Treatment and Reuse by Land Application. U.S. Environmental Protection Agency. EPA-660/2-73-006a and b. August 1973.
19. Leach, E., C.G. Enfield, and C.C. Harlin, Jr. Summary of Long-Term Rapid Infiltration System Studies. U.S. Environmental Protection Agency. EPA-600/2-80-165. July 1980.
20. Lance, J.C., F.D. Whisler, and R.C. Rice. Maximizing Denitrification During Soil Filtration of Sewage Water. Journal of Environmental Quality. 5:102. 1976.

21. Clapp, R.B. and G.M. Hornberger. Empirical Equations for Some Soil Hydraulic Properties. Water Resources Research. 14(4):601-604. 1978.
22. Bower, H. Infiltration - Percolation Systems. In: Land Application of Wastewater. Proceedings of a Research Symposium Sponsored by the USEPA, Region III, Newark, Delaware. pp. 85-92. November, 1974.
23. Bower, H. Zoning Aquifers for Tertiary Treatment of Wastewater. Ground Water. 14(6):386. November-December 1976.
24. Bianchi, W.C. and C. Muckel. Ground-Water Recharge Hydrology. U.S. Department of Agriculture, Agricultural Research Service. ARS 41161. December 1970.
25. Hantush, M.S. Growth and Decay of Groundwater-Mounds in Response to Uniform Percolation. Water Resources Research. 3(1):227-234. 1967.
26. Bower, H. Renovating Secondary Effluent by Groundwater Recharge with Infiltration Basins. In: Conference on Recycling Treated Municipal Wastewater Through Forest and Cropland. U.S. Environmental Protection Agency. EPA-660/2-74-003. 1974.
27. Kirkham, D., S. Toksoz, and R.R. van der Ploeg. Steady Flow to Drains and Wells. In: Drainage for Agriculture. J. van Schifgaarde, ed. American Society of Agronomy Series on Agronomy, No. 17. 1974.
28. Drainage Manual. U.S. Department of the Interior, Bureau of Reclamation. 1978.
29. Drainage for Agriculture. J. van Schifgaarde, ed. American Society of Agronomy Series on Agronomy, No. 17. 1974.
30. Campbell, M.D. and J.H. Lehr. Water Well Technology. McGraw-Hill, Inc. New York. 1973.
31. Blakeslee, P.A. Monitoring Considerations for Municipal Wastewater Effluent and Sludge Application to Land. In: Proceedings of the Joint Conference on Recycling Municipal Sludges and Effluents on Land, Champaign, Illinois. July 9-13, 1973.

32. Dunlap, W.J., et al. Sampling for Organic Chemicals and Microorganisms in the Subsurface. U.S. Environmental Protection Agency. EPA-600/2-77-176. August 1977.

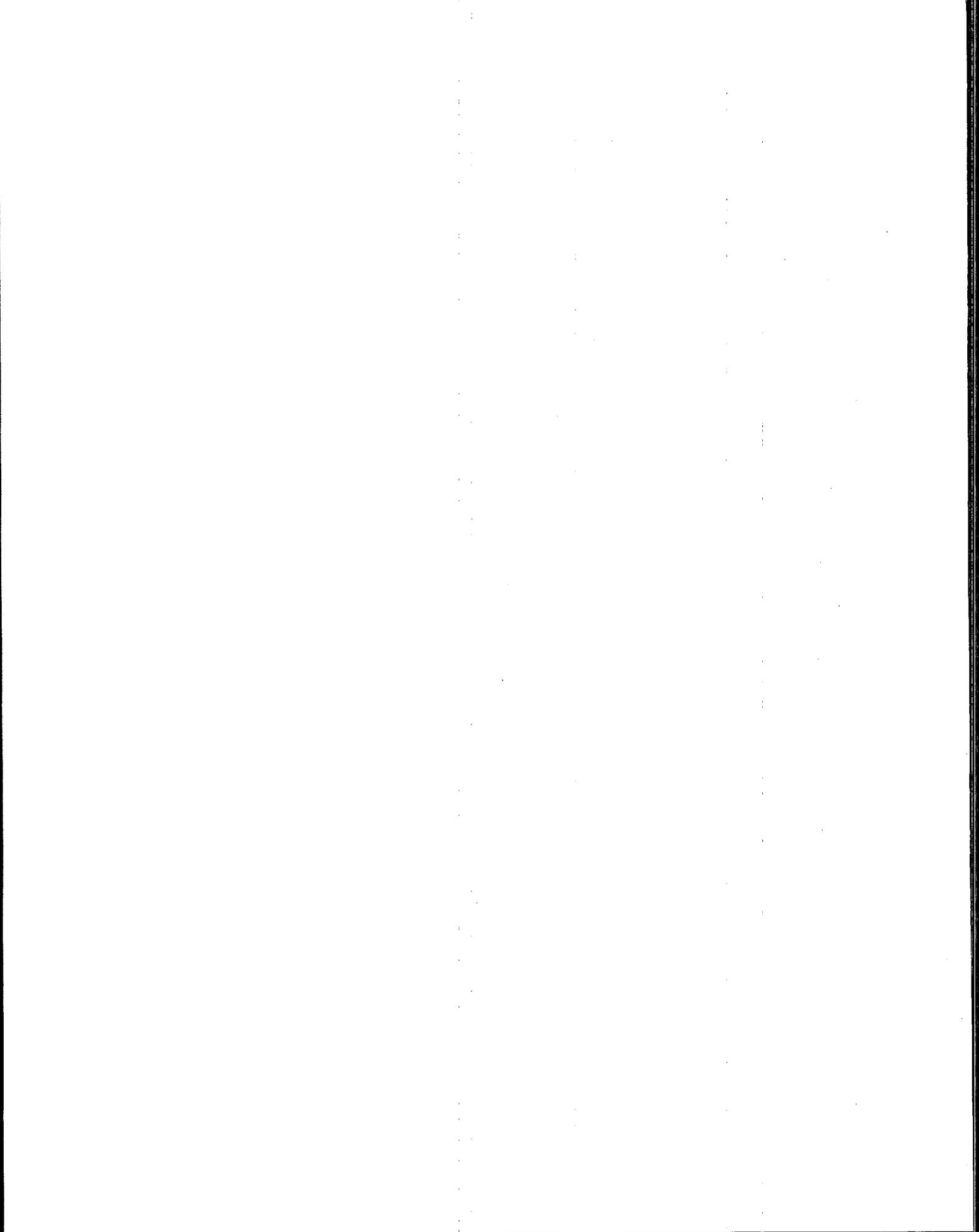

CHAPTER 6

OVERLAND FLOW PROCESS DESIGN

6.1 Introduction

The design procedure for overland flow (OF) is presented in Figure 6-1. Application rate and hydraulic loading rate determinations are the most important design steps because these values plus the storage requirement fix the land area requirements. Preapplication treatment can be increased if inadequate land area is available.

6.1.1 Site Characteristics and Evaluation

Overland flow is best suited for use at sites having surface soils that are slowly permeable or have a restrictive layer such as a claypan at depths of 0.3 to 0.6 m (1 to 2 ft). Overland flow can also be used on moderately permeable soils using higher loading rates than would be possible with an SR system. It is possible to design an OF system on very permeable soils by constructing an artificial barrier to prevent downward water movement through the soil, although the capital costs of such construction may be prohibitive for all but the smallest systems.

Overland flow may be used at sites with gently sloping terrain with grades in the range of 1 to 12%. Slopes can be constructed on nearly level terrain and terraced construction can be used when the natural slope grade exceeds about 10%. Topographic maps of proposed sites with 0.3 m (1 ft) contour intervals should be used in detailed site evaluation.

6.1.2 Water Quality Requirements

Most of the treated water leaving an OF site occurs as surface runoff, and discharge requirements to receiving waters must be met. Protection of ground water quality at OF sites is generally ensured by the fact that little water (usually less than 20%) percolates and the heavy clay soils remove most of the pollutants. Based on limited experience with OF on moderately permeable soils, a long-term decrease in the percolation rate can be expected due to clogging of soil pores and a relatively small percentage of the applied wastewater will percolate. If OF is considered for use on moderately permeable soils, however, it is recommended that consideration be given to ground water impacts as discussed for SR systems in Chapters 4 and 9.

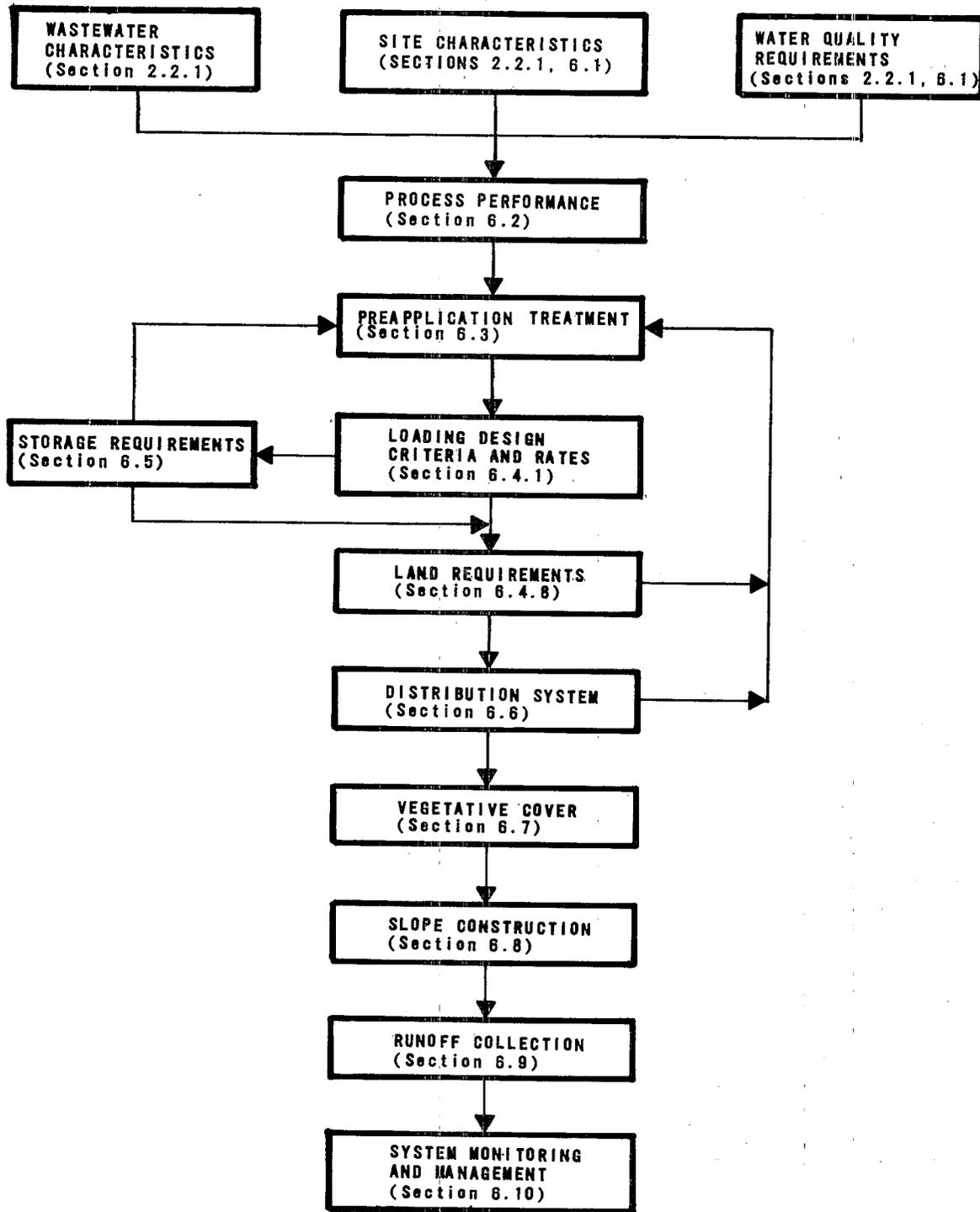

**FIGURE 6-1
OVERLAND FLOW DESIGN PROCEDURE**

6.1.3 Design and Operating Parameters

The basic design and operating parameters are defined in Table 6-1.

TABLE 6-1
OF DESIGN AND OPERATING PARAMETERS

Parameter	Definition	Range of values in practice
Hydraulic loading rate	Average flowrate divided by the wetted slope area	0.6-6.7 cm/d 6.3-40 cm/wk
Application rate	Flowrate applied to the slope per unit width of slope	0.03-0.24 m ³ /m·h
Application period	Length of time per day of wastewater application	5-24 h/d
Application frequency	Number of days per week that wastewater is applied to the slope	5-7 d/wk

Note: See Appendix G for metric conversions.

6.2 Process Performance

Knowledge of the relationship of process performance and design criteria for OF systems is necessary before the design can be accomplished. The removal mechanisms discussed in this section relate to operating parameters, slope lengths, and levels of preapplication treatment. A summary of design and operating characteristics for existing municipal OF systems is presented in Tables 6-2 and 6-3. Health and environmental effects of trace elements and trace organics are discussed in Chapter 9.

6.2.1 BOD Removal

Biological oxidation is the principal mechanism responsible for the removal of soluble organic materials in the wastewater. The diverse microbial populations in the soil and the surface organic layer sorb and subsequently oxidize these substances into stable end products much like the biological slimes on trickling filter media. Suspended and colloidal organic materials, which contribute about 50% of the BOD load in raw domestic sewage, are removed by sedimentation and filtration through the surface grass and organic layers. Subsequent breakdown of the degradable settled particulate materials is also achieved by the microorganisms on the slope. Typical removals of BOD are presented in Table 6-2.

TABLE 6-2
SUMMARY OF PROCESS OPERATING PARAMETERS,
BOD AND SS PERFORMANCE AT OF SYSTEMS^a

Wastewater applied	Location	Slope length, m	Application rate, m ³ /m ² -h	Hydraulic loading rate, cm/d	Application		BOD, mg/L		SS, Mg/L		Reference
					Period, h/d	Frequency, d/wk	Influent	Effluent	Influent	Effluent	
Raw wastewater	Ada, Oklahoma	36	0.075	1.63	8	6	150	8	160	8	[1]
	Pauls Valley, Oklahoma	46	0.098	3.3	12	6	132	10	185	16	[1]
	Easley, South Carolina	55	0.041	0.73	8	7	117	14.8	105	5.2	[2]
Primary effluent	Ada, Oklahoma	36	0.065	2.5	12	6	70	8	56	7	[1]
	Hanover, New Hampshire	30.5	0.075	1.25	5	5	72	9	74	10	[4]
	Melbourne, Australia	250	0.127	2.8	7	5	72	9	59	7	[5]
Secondary effluent	Ada, Oklahoma	36	0.24	2.3	24	7	507	12	233	19	[6]
	Hanover, New Hampshire	30.5	0.12	4.2	12	6	18	6	12	5	[1]
	Pauls Valley, Oklahoma	46	0.20	6.7	12	6	18	5	12	5	[1]
Stabilization pond effluent	Hanover, New Hampshire	30.5	0.075	1.25	5	5	45	5	47	3	[4]
	Pauls Valley, Oklahoma	46	0.06	1.66	12	7	27.7	20.5	114	72.8	[2]
	Utica, Mississippi	46	0.032	1.27	18	5	22	3.5	30	5.5	[7]
Stabilization pond effluent	Utica, Mississippi	46	0.065	2.54	18	5	22	4.0	30	8.0	[7]
	Pauls Valley, Oklahoma	46	0.049	2.54	24	7	22	5.5	30	13.0	[7]
	Pauls Valley, Oklahoma	46	0.13	5.08	18	5	22	7.5	30	13.0	[7]
	Pauls Valley, Oklahoma	46	0.10	1.27	6	5	22	8.6	30	6.4	[7]
	Easley, South Carolina	46	0.23	3.58	7	5	28	15	60	40	[3]
	Easley, South Carolina	46	0.23	3.58	7	5	28	15	60	40	[3]

a. Performance during warm season

TABLE 6-3
SUMMARY OF NITROGEN AND PHOSPHORUS
PERFORMANCE AT OF SYSTEMS^a

Wastewater applied	Location	Hydraulic loading rate, cm/d	Total N, mg/L		Ammonia-N, mg/L		Nitrate-N, mg/L		Total P, mg/L		Reference
			Influent	Effluent	Influent	Effluent	Influent	Effluent	Influent	Effluent	
Raw wastewater	Ada, Oklahoma	1.63	23.6	2.1	17.0	0.6	0.8	0.4	10.0	4.3	[1]
	Pauls Valley, Oklahoma	3.3	34.0	7	23.0	2	<1	2	8	4.5	[1]
	Pauls Valley, Oklahoma	0.73	24.2	9.8	16.7	5.3	<0.1	0.4	8.3	8.7	[2]
Primary effluent	Easley, South Carolina	2.36	30.5	7.7	16.0	3.3	1.4	0.3	8.9	4.0	[3]
	Ada, Oklahoma	2.5	19	5	14.0	1.5	1	3	7	4.7	[1]
	Ada, Oklahoma	3.3	19	5	14.0	1.5	1	3	7	5.2	[1]
	Hanover, New Hampshire	1.25	45	9.4	37.6	5.8	0.9	1.6	5.7	1.1	[4]
	Hanover, New Hampshire	2.8	36	11.3	24.0	4.5	<0.1	3.5	6.6	4.4	[5]
Secondary effluent	Melbourne, Australia	2.3	55.6	39.7	31	31	<0.1	0.3	9.0	8.4	[6]
	Ada, Oklahoma	4.2	16	8.5	6	0.5	8	5.5	7	5.0	[1]
	Ada, Oklahoma	6.7	16	8.5	6	0.5	8	7.5	7	5.9	[1]
	Hanover, New Hampshire	1.25	31.3	13.7	21.7	4	7.1	6.2	6.0	3.6	[4]
Stabilization Pond effluent	Pauls Valley, Oklahoma	1.66	15.5	11.4	1.7	0.4	<0.1	0.2	6.3	5.1	[2]
	Utica, Mississippi	1.27	20.5	4.3	15.6	0.1	<1.0	1.0	10.3	4.9	[7]
	Utica, Mississippi	2.54	20.5	7.5	15.6	0.8	<1.0	2.6	10.3	6.1	[7]
	Utica, Mississippi	2.54	20.5	7.3	15.6	0.7	<1.0	3.1	10.3	5.9	[7]
	Utica, Mississippi	5.08	20.5	10.0	15.6	1.1	<1.0	4.8	10.3	8.2	[7]
	Utica, Mississippi	1.27	20.5	7.0	15.6	0.8	<1.0	3.2	10.3	7.1	[7]
	Easley, South Carolina	3.58	6.7	2.1	1.0	0.4	2.4	1.1	3.8	2.2	[3]
	Easley, South Carolina	3.58	6.7	2.1	1.0	0.4	2.4	1.1	3.8	2.2	[3]
	Easley, South Carolina	3.58	6.7	2.1	1.0	0.4	2.4	1.1	3.8	2.2	[3]
	Easley, South Carolina	3.58	6.7	2.1	1.0	0.4	2.4	1.1	3.8	2.2	[3]

a. Performance during warm season.

The performance of OF systems treating primary and secondary effluent in cold regions was evaluated in Hanover, New Hampshire [4]. For primary effluent, it was found that runoff BOD concentration was not substantially affected by temperature until the soil temperature dropped to about 10 °C (50 °F). Below 10 °C, effluent BOD levels increased with decreasing temperatures. At soil temperatures below 4 °C (39 °F) effluent BOD levels exceeded 30 mg/L. For secondary effluent, OF effluent BOD values remained below 15 mg/L at soil temperatures of 4 °C. Storage may be required during cold weather to meet stringent BOD discharge requirements.

Relationships between BOD removal and the process operating parameters are not well defined. However, results of recent studies conducted to develop rational design methods for OF indicate that, for primary effluent, BOD removal is largely a function of application rate and slope length and is independent of hydraulic loading rate within the ranges used at existing systems [5, 8] (see Section 6.11).

6.2.2 Suspended Solids Removal

Suspended and colloidal solids are removed by sedimentation, filtration through the grass and litter, and adsorption on the biological slime layer. Because of the low flow velocities and shallow flow depths on the OF slopes, most SS are removed within a few meters from the point of application.

Removal of algae from stabilization pond effluent by OF systems is somewhat variable and depends on the nature of the algae. If OF is not being used in the locality for treatment of pond effluent, pilot studies may be advised to ascertain treatability.

Removal of SS requires that a thick stand of vegetation be maintained and that gullies or other short-circuiting down the slopes be avoided. Removal of SS is relatively unaffected by cold weather or changes in process loading parameters compared to BOD removal.

6.2.3 Nitrogen Removal

Important mechanisms responsible for nitrogen removal by OF include crop uptake, biological nitrification-denitrification, and ammonia volatilization. Removal of nitrogen by crop harvest depends on the nitrogen content of the crop and the dry matter yield of the crop as discussed in Section 4.3.2.1. The water tolerant forage grasses used for OF generally have high nitrogen uptake capacities.

Annual nitrogen uptake measured at the Utica, Mississippi, system for a grass mixture of Reed canary, Kentucky 31 tall fescue, perennial ryegrass, and common Bermuda ranged between 222 and 179 kg/ha (198 and 160 lb/acre). Crop uptake at the Utica system accounted for approximately 11 and 33% percent of the applied nitrogen at the high and low hydraulic loading rates, respectively (see Table 6-3) [7].

Ammonia volatilization is known to occur during OF. Researchers at the Utica site estimated volatilization losses to be about 9% of the applied pond effluent nitrogen [7].

Nitrification-denitrification is usually the major removal mechanism. At Utica, the losses attributable to denitrification ranged from 34 to 42% of the applied nitrogen [7].

Nitrification takes place in the aerobic environment at the soil surface. The nitrates then diffuse through the organic-rich surface materials where anaerobic conditions necessary for denitrification exist. Denitrification requires the presence of a readily available carbon source. Consequently, the best nitrogen removals are found using raw wastewater or primary effluent that have high carbon to nitrogen ratios (>3). Lesser nitrogen removals are found using secondary or pond effluent when the carbon to nitrogen ratios are about one.

Typical effluent values for the different nitrogen forms are indicated in Table 6-3. The effects of operating parameters on nitrogen removal are not well understood. Specific design and operating criteria to optimize nitrogen removal or ammonia conversion have not been established. However, some general relationships can be stated:

1. Total nitrogen and ammonia removal is inversely related to application rate and directly related to slope length.
2. The rate of nitrification is reduced if wastewater is applied continuously.
3. The overall nitrogen removal and ammonia conversion efficiency is reduced as the soil temperature drops below 13 to 14 °C (55 to 57 °F). With pond effluent at the Utica system, nitrogen removal efficiency decreased from 90% in the spring and summer to less than 80% during the winter [2]. Results obtained at the Hanover system with primary and secondary effluents, showed that nitrogen removal efficiency dropped to about 30% during the

winter [5]. The reduced efficiency in colder temperatures is attributed to the decreased rate of the biological nitrification-denitrification process as well as reduced plant uptake.

6.2.4 Phosphorus Removal

The major mechanisms responsible for phosphorus removal by OF include sorption on soil clay colloids and precipitation as insoluble complexes of calcium, iron, and aluminum. When low permeability surface soils are present, as is the case for most OF systems, much of the applied wastewater flows over the surface and does not contact the soil matrix and phosphorus adsorption sites. As a result of this limited soil contact, phosphorus removals achieved at existing OF systems generally range from 40 to 60%. Phosphorus data from some OF systems are shown in Table 6-3.

Improved phosphorus removal efficiency can be achieved by the addition of aluminum sulfate to the wastewater prior to application to the land. Applications of aluminum sulfate to raw sewage at a concentration of 20 mg/L reduced the phosphorus concentration from 8.8 mg/L to 1.5 mg/L or 85% removal efficiency in experiments at Ada, Oklahoma [9]. Addition of aluminum sulfate to stabilization pond effluent in amounts equal to 1:1, aluminum to phosphorus, prior to application resulted in significant reduction of phosphorus in the runoff to about 1 mg/L or removal efficiency better than 80% at the Utica system [10].

6.2.5 Trace Element Removal

The major mechanisms responsible for trace element removal include sorption on clay colloids and organic matter at the soil surface layer, precipitation as insoluble hydroxy complexes, and formation of organometallic complexes with the organic matter at the slope surface. The largest proportion of the heavy metals accumulate in the biomass on the soil surface and close to the point of effluent application. Trace metal removal data reported from the Utica system are presented in Table 6-4 to illustrate the removal levels that can be achieved with OF.

6.2.6 Microorganism Removal

The major mechanisms responsible for removal of microorganisms in OF systems include sedimentation, filtration through surface organic layer and vegetation, sorption to soil particles, predation, irradiation, and desiccation during drying periods.

TABLE 6-4
REMOVAL EFFICIENCY OF HEAVY METALS
AT DIFFERENT HYDRAULIC RATES AT
UTICA, MISSISSIPPI [7]

Hydraulic loading rate, cm/d	Runoff concentration, mg/L				Removal efficiency, %			
	Cadmium	Nickel	Copper	Zinc	Cadmium	Nickel	Copper	Zinc
1.27	0.0046	0.0131	0.0129	0.0558	85.4	92.1	93.1	88.4
2.54	0.0036	0.0217	0.0293	0.0525	90.9	87.6	82.4	87.4
3.81	0.0079	0.0302	0.0382	0.0757	77.7	79.6	73.5	78.8
5.08	0.0142	0.0486	0.0524	0.0853	63.2	66.0	64.4	75.4

Generally, the removal efficiency of OF systems for pathogenic organisms such as viruses and indicator organisms is comparable to that which is achieved in conventional secondary treatment systems without chlorination. Disinfection may be required by the regulatory agency.

6.2.7 Trace Organics Removal

Removal of trace organics in OF systems is achieved by the mechanisms of sorption on soil clay colloids or organic matter, biodegradation, photodecomposition, and volatilization. The importance of one or a combination of these mechanisms will depend on the nature of the trace organic substance.

6.2.8 Effect of Rainfall

The effect of rainfall on OF process performance was studied at Paris, Texas; Utica, Mississippi; Ada, Oklahoma; and Hanover, New Hampshire [11, 7, 4]. In all of these studies, it was observed that precipitation events occurring during application did not significantly affect the concentration of the major constituents in the runoff. However, the mass discharges of constituents did increase due to the increased water volume from the storm events. In situations where discharge permits are based on mass discharge, discussions with regulatory officials should be held to determine if permits can be written to reflect background loadings occurring as a result of rainfall runoff from OF fields or to allow higher mass discharges during periods of high flow in receiving waters. In some cases, collection and recycle of stormwater may be necessary.

6.2.9 Effect of Slope Grade

The effect of slope grade on treatment performance has been evaluated at several systems [2, 7, 8]. The conclusion from all studies was that slope grade in the range of 2 to 8% does not significantly affect treatment performance when systems are operated within the range of application rates reported in Table 6-2.

6.2.10 Performance During Startup

A period of slope aging or acclimation is required following initial startup before process performance approaches satisfactory levels. During this period, the microbial population on the slopes is increasing and slime layers are forming. The initial acclimation period may be as long as 3 to 4 months. If a variance to allow discharge during this period can not be obtained, provisions should be made to store and/or recycle the effluent until effluent quality improves to the required level.

An acclimation period also should be provided following winter storage periods for those systems in cold climates. Acclimation following winter shutdown should require less than 1 month. Acclimation is not necessary following shutdown for harvest unless the harvest period is extended to more than 2 or 3 weeks due to inclement weather.

6.3 Preapplication Treatment

Preapplication treatment before OF is provided to (1) prevent operating problems with distribution systems and, (2) prevent nuisance conditions during storage. Preapplication treatment to protect public health is not usually a consideration with OF systems because public contact with the treatment site is usually controlled and no crops are grown for human consumption.

Except in the case of harmful or toxic substances from industrial sources (see Section 4.4.3), preapplication treatment of municipal wastewater is not necessary for the OF process to achieve maximum treatment. The OF process is capable of removing higher levels of constituents than are normally present in municipal wastewater and maximum use should be made of this renovating capacity. Consequently, the level of preapplication treatment provided should be the minimum necessary to achieve the two stated objectives. Any additional treatment, in most cases, will only increase costs and energy use, and, in some cases, can impair or reduce the consistency of process performance. Algal solids have proven difficult to remove from some stabilization pond

effluents and reduced nitrogen removals have been observed with secondary effluents. These statements do not imply that existing treatment facilities should not be considered for use in preapplication treatment.

The EPA has issued guidelines for assessing the level of preapplication treatment necessary for OF systems. The guidelines are as follows:

1. Screening or comminution--acceptable for isolated sites with no public access.
2. Screening or comminution plus aeration to control odors during storage or application--acceptable for urban locations with no public access.

Municipal wastewater contains rags, paper, hair, and other large articles that can blind and clog orifices and valves in surface and sprinkler distribution systems. Comminution is generally not sufficient to eliminate clogging problems. Fine screening or primary sedimentation with surface skimming is necessary to prevent operating difficulties. For sprinkler distribution systems, screen sizes should be less than one-third the diameter of the sprinkler nozzle. Static inclined screens with 1.5 mm (0.06 in.) openings have been used successfully for raw wastewater screening.

Grit removal is advisable for wastewaters containing high grit loads. Grit reduces pump life and can deposit in low velocity distribution pipelines.

6.4 Design Criteria Selection

The principal OF design and operating parameters are defined in Section 6.1 and values used at existing systems are given in Table 6-1. Traditionally, OF design and operation has been an empirical procedure based on a set of general guidelines established through successive trials with the various process parameters at different OF systems. The guidelines, as presented here, reflect successful construction and operation of full-scale systems, but the degree of conservatism inherent in the guidelines has not been established. The design criteria shown in Table 6-5 have been used at existing OF systems during spring, summer, and fall to achieve effluent BOD and suspended solids concentrations less than 20 mg/L, total nitrogen less than 10 mg/L, ammonia nitrogen less than 5 mg/L, and total phosphorus less than 6 mg/L.

TABLE 6-5
OVERLAND FLOW DESIGN GUIDELINES

Preapplication treatment	Hydraulic loading rate, cm/d	Application rate, m ³ /m·h	Application period, h/d	Application frequency, d/wk	Slope length, m
Screening	0.9-3	0.07-0.12	8-12	5-7	36-45
Primary sedimentation	1.4-4	0.08-0.12	8-12	5-7	30-36
Stabilization pond	1.3-3.3	0.03-0.10	8-18	5-7	45
Complete secondary biological	2.8-6.7	0.10-0.20	8-12	5-7	30-36

6.4.1 Hydraulic Loading Rate

Traditionally, hydraulic loading rate has been used as the principal OF design parameter. Current guidelines call for hydraulic loadings rates to be varied with the degree of preapplication treatment as indicated in Table 6-5. For systems operating year-round, the hydraulic loading rates generally have been reduced during the winter to compensate for the reduction in BOD and nitrogen removal efficiency when soil temperatures drop below 10 to 15 °C (50 to 59 °F) (see Sections 6.2.1 and 6.2.3). Reductions in hydraulic loading rates during the winter have been somewhat arbitrary and guidelines are not well established. A 30% reduction from summer rates has been used at the Ada system while a 50% reduction has been recommended at the Utica system.

The performance of OF systems is dependent on the detention time of the wastewater on the slope. The detention time is in turn directly related to the application rate. Therefore, it is possible to compensate for lower winter temperatures by decreasing the application rate and increasing the application period while maintaining the hydraulic loading rate constant. It is also possible to increase hydraulic loading rates for short periods, such as when a portion of the system is shutdown for harvesting or repair, without affecting performance, by increasing the application period and maintaining the application rate constant.

6.4.2 Application Rate

Design guidelines for application rates based on existing systems are presented in Table 6-5. Values at the high end of the range may be used during spring, summer, and fall, while values at the low end should be used when soil temperatures drop below about 10 °C or if maximum removal efficiency for any constituent is desired. These rates are based on slope lengths in the range of 30 to 40 m (98 to

131 ft). Application rates less than the minimum values shown in Table 6-5 may be difficult to distribute uniformly with surface distribution systems.

Hydraulic loading rate is related to application rate, period, and the slope length as shown in Equation 6-1.

$$L_w = \frac{(R_a)(P)}{S} (100 \text{ cm/m}) \quad (6-1)$$

where L_w = hydraulic loading rate, cm/d

R_a = application rate, $\text{m}^3/\text{h}\cdot\text{m}$

P = application period, h/d

S = slope length, m

The calculation can be started in one of two ways:

1. Select application rate, period, and slope length and calculate hydraulic loading rate, or
2. Select application period, slope length, and hydraulic loading rate and calculate application rate.

6.4.3 Application Period

A wide range of application periods has been used successfully, ranging from just a few hours to as high as 24 h/d. The application periods that have been used most frequently in existing OF projects range between 6 and 12 h/d.

Use of design application periods of 12 h/d or less allows more operating flexibility during periods when parts of the system must be shutdown for harvest or repair. For instance, if the design application period is 8 h/d, wastewater normally would be applied to one-third of the total land area at any given time assuming a 24-hour system operation. If one-third of the system were shutdown for harvest, the application period could be increased to 12 h/d on the remaining two portions of the system, and the entire flow could be applied without increasing the application rate.

Systems generally are designed to operate on a 24 hour basis to minimize land requirements. For small systems, it may be more convenient or cost effective to operate only during one

working shift. In this case, the entire land area would receive the full design daily wastewater flow during the 8 hour application period. Storage facilities would be required to hold wastewater flow during the 16 hour nonoperating period.

6.4.4 Application Frequency

A design application frequency of 7 d/wk is generally used to minimize land area requirements and eliminate or reduce storage requirements. There does not appear to be any advantage in terms of process performance to using less frequent applications. For small systems with storage facilities, it may be more convenient to use an application frequency of 5 d/wk and shut down on weekends.

6.4.5 Constituent Loading Rates

Historically, OF design and operation has not been based on mass loading rates of wastewater constituents such as BOD, suspended solids, and nitrogen. The rates used at existing systems apparently are well below those that might affect process performance, since no correlations between process performance and constituent loading have been found.

6.4.6 Slope Length

In general, OF process performance has been shown to be directly related to slope length and inversely related to application rate (see Section 6.11). Thus, longer slope lengths should be used with higher application rates or, conversely, shorter slope lengths should be used with lower application rates to achieve an equivalent degree of treatment. The combinations of slope lengths and application rates that are suggested for design are indicated in Table 6-5.

The minimum slope lengths indicated have been used with surface distribution systems or low-pressure spray systems that distribute the wastewater across the top of the slope. Traditionally, longer slope lengths (45 to 60 m or 150 to 200 ft) have been used with full-circle, high-pressure impact sprinklers. However, nearly all of the experience with impact sprinkler OF distribution systems has been with high strength food processing wastewater. There are no data to indicate the need for longer slope lengths when using sprinklers to apply municipal wastewater. Without such information, the recommended minimum slope length for sprinkler distribution systems is 45 m (150 ft) for part circle sprinklers. For full circle sprinklers, the recommended minimum slope length is the sprinkler diameter plus about 20 m (65 ft).

From a process control standpoint, it is desirable to have all slopes approximately the same length. However, this may not always be possible due to the shape of the site boundaries or site topography. If slope length must differ substantially (>10 m or 33 ft) from the design value, then the application rate used on these slopes may need to be adjusted. For design, a first approximation to the adjusted rate may be made by equalizing the hydraulic loading rate on all slopes. Equation 6-1 may be used to estimate the necessary application rate. Adjustment in the field during operation may be necessary to achieve equivalent treatment.

6.4.7 Slope Grade

Although slope grades ranging from less than 1% to 10 or 12% have been used effectively for OF, experience has shown the optimum range to be between 2 and 8%. Slope grades less than 2% increase the potential for ponding, while those greater than 8% increase the risk of erosion. It has been shown through several studies that slope grades in the range of 2 to 8% do not affect process performance. Therefore, there is no need to adjust slope length or application rate for changes in slope grade within this range. Slope grades greater than about 8% also increase the risk of short circuiting and channeling and may require lower application rates or longer slope lengths to achieve adequate treatment, although there are no performance data to confirm this.

Although there exist some circumstances where natural ground contours can provide the slope grade necessary for effective treatment, few sites offer conditions that are ideal for the smooth sheet flow of water along the ground surface, which is important to the OF concept. Therefore, it is almost always necessary to reshape the site into a network of slopes that conform to the length and grade guidelines outlined previously. The grade of each slope is established by the existing site conditions. For example, if the site has a general slope grade of 4%, the slope should also be shaped to 4% grades. If the site is very flat, 2% grades should be used. If the site is quite steep, the slope grades should be reduced to 8%. This procedure will minimize the cost required to reshape the site. Since natural grades can vary considerably within the confines of a specific site, the individual OF slopes can vary in grade although each should be within the 2 to 8% range.

6.4.8 Land Requirements

The area of land to which wastewater is actually applied is termed slope area. In addition to the slope area, the total

land area required for an OF system includes land for pre-application treatment, administration and maintenance buildings, service roads, buffer zones (see Section 4.5.4.2), and storage facilities. At existing systems, other area requirements (not including buffer zones or storage facilities) have ranged from 15 to 40% of the slope area.

For systems where storage is provided, the slope area requirement may be calculated using the following equations.

$$A_s = \frac{Q(365 \text{ d/yr}) + \Delta V_s}{(D_a)(L_w)(10^4 \text{ m}^2/\text{ha})(10^{-2} \text{ m/cm})} \quad (6-2)$$

where A_s = slope area, ha

ΔV_s = net loss or gain in storage volume due to precipitation, evaporation, and seepage, m^3/yr

Q = average daily flow, m^3/d

D_a = number of operating days/yr

L_w = design hydraulic loading rate, cm/d

The value of ΔV_s depends on the area of the storage reservoir. Thus, the final design slope area must be determined after the storage reservoir dimensions are determined.

Combining equations 6-1 and 6-2 allows calculation of A_s based on application rate and slope length. Equations 6-2 and 6-3 can also be used for systems with no storage since the term ΔV_s will then be equal to zero.

$$A_s = \frac{Q(365 \text{ d/yr}) + \Delta V_s}{\frac{(D_a)(R_a)(P)}{S}(10^4 \text{ m}^2/\text{ha})} \quad (6-3)$$

where A_s = slope area, ha

Q = average daily flow, m^3/d

ΔV_s = net storage gain or loss, m^3/yr

D_a = number of operating days per year

R_a = design application rate, $m^3/h \cdot m$

P = design application period, h/d

S = slope length, m

Equations 6-2 and 6-3 may also be used for systems in warmer climates that operate year-round without reducing hydraulic loading rates during the winter. As stated previously, it is possible to compensate for lower removal efficiency at low soil temperatures, without reducing hydraulic loading rates, by decreasing the application rate and increasing the application period. This winter operating procedure will minimize slope area requirements and eliminate the need for any winter storage.

If lower hydraulic loading rates are used during the winter, for a system operating year-round, the designer has two alternative approaches that may be used to determine the slope area requirements. Under the first alternative, slope area requirement is based only on the winter hydraulic loading rate, in which case no winter storage will be required. Under the second alternative, slope area would be based on the higher hydraulic loading rates used during the rest of the year, in which case a portion of the winter flow would have to be stored. The first approach would result in maximum land area requirements and conservative loadings during the warmer periods of the year, but would eliminate storage requirements. The second approach would minimize land area requirement but may require preapplication treatment facilities for storage. An economic analysis should be performed to determine which alternative is most cost-effective. If storage facilities are going to be provided for other reasons (see Section 6.5), then the second alternative will probably prove most cost effective.

Slope area requirements using the first alternative may be computed using the following equation, assuming a 7 d/wk application frequency:

$$A_s = \frac{Q_w}{(L_{ww})(10^4 \text{ m}^2/\text{ha})(10^{-2} \text{ m/cm})} \quad (6-4)$$

where A_s = slope area, ha

Q_w = average daily flow during winter, m^3/d

L_{ww} = winter hydraulic loading rate, cm/d

Slope area requirements using the second alternative may be computed using the following equation:

$$A_s = \frac{(Q)(365 \text{ d/yr}) + \Delta V_s}{(L_{ww})(D_{aw}) + (L_{ws})(D_{as})(10^4 \text{ m}^2/\text{ha})(10^{-2} \text{ m/cm})}$$

where A_s = slope area, ha

Q = annual average daily flow, m^3/d

ΔV_s = net gain or loss of water from storage, m^3/yr

L_{ww} = winter hydraulic loading rate, cm/d

D_{aw} = number of operating days at winter rate

L_{ws} = non-winter hydraulic loading rate, cm/d

D_{as} = number of operating days at non-winter rates

6.5 Storage Requirements

Storage facilities may be required at an OF system for any of the following three reasons:

1. Storage of water during the winter due to reduced hydraulic loading rates or complete shutdown.
2. Storage of stormwater runoff to meet mass discharge limitations.
3. Equalization of incoming flows to permit constant application rates.

Estimating storage volume requirements for the above reasons is discussed in this section. Storage reservoir design considerations are discussed in Section 4.6.3.

6.5.1 Storage Requirements for Cold Weather

Due to the limited operating experience with OF in different parts of the country, cold weather storage requirements are not well defined. In general, OF systems must be shut down for the winter when effluent quality requirements cannot be met due to cold temperatures even at reduced application rates or when ice begins to form on the slope. The duration of the shutdown period and, consequently, the required storage period will, of course, vary with the local climate and the required effluent quality.

In studies at the Hanover system, a storage period of 112 days including acclimation was estimated to be required when treating primary effluent to BOD and suspended solids limits of 30 mg/L [4]. This estimate was reasonably close to the 130 storage days predicted by the EPA-1 program using 0 °C (32 °F) mean temperature (see Section 4.6.2). For design purposes, the EPA-1 or EPA-3 programs may be used to conservatively estimate winter storage requirements for OF. A map showing estimated storage days from the EPA-1 program is shown in Figure 2-5 and tabulated data are presented in Appendix F. In areas of the country below the 40 day storage contour, OF systems generally can be operated year-round. However, winter temperature data at the proposed OF site should be compared with those at existing systems that operate year-round to determine if all year operation is feasible.

Storage is required at OF systems that are operated year-round but at reduced hydraulic loading rates during the winter. The required storage volume for such systems can be estimated using the following equation:

$$V_S = (Q_w)(D_w) - (A_S)(L_{ww})(D_{aw})(10^{-2} \text{ m/cm}) \quad (6-6)$$

where V_S = storage volume, m^3

Q_w = average daily flow during winter, m^3/d

D_w = number of days in winter period

A_S = slope area, m^2

L_{ww} = hydraulic loading rate during winter, cm/d

D_{aw} = number of operating days in winter period

The duration of the reduced loading period at existing systems generally has been about 90 days.

Unless the winter storage reservoir is an integral part of the preapplication treatment system, the winter storage reservoir should be bypassed during the warm season operation to minimize algae production in the applied wastewater and to minimize energy costs for prestorage treatment. Stored water should be blended with fresh incoming wastewater before application on the OF slopes.

6.5.2 Storage for Stormwater Runoff

In some cases, discharge permits may allow discharge of stormwater runoff from the OF system but require monthly

mass discharges for certain constituents to be within specified limits. In such cases, stormwater runoff may need to be stored and discharged at a later time when mass discharge limits would not be exceeded. A procedure for estimating storage requirements for stormwater runoff is outlined below.

1. Determine the maximum monthly mass discharge allowed by the permit for each regulated constituent.
2. Determine expected runoff concentrations of regulated constituents under normal operation (no precipitation).
3. Estimate monthly runoff volumes from the system under normal operation by subtracting estimated monthly ET and percolation losses from design hydraulic loading.
4. Estimate the monthly mass discharge under normal operation by multiplying the values from Steps 2 and 3.
5. Calculate the allowable mass discharge of regulated constituents resulting from storm runoff by subtracting the estimated monthly mass discharge in Step 3 from the permit value in Step 1.
6. Assuming that storm runoff contains the same concentration of constituents as runoff during normal operation, calculate the volume of storm runoff required to produce a mass discharge equal to the value in Step 5.
7. Estimate runoff as a fraction of rainfall for the particular site soil conditions. Consult the local SCS office for guidance.
8. Calculate the total rainfall required to produce a mass discharge equal to the value in Step 5 by dividing the value in Step 6 by the value in Step 7.
9. Determine for each month a probability distribution for rainfall amounts and the probability that the rainfall amount in Step 8 will be exceeded.
10. In consultation with regulatory officials, determine what probability is an acceptable risk before storm runoff storage is required and use this value (P_d) for design.

11. Storage must be provided for those months in which total rainfall probability exceeds the design value (P_d) determined in Step 10.
12. Determine the change in storage volume each month by subtracting the allowable runoff volume in Step 6 from the runoff volume expected from rainfall having an occurrence probability of P_d . In months when the expected storm runoff exceeds the allowable storm runoff, the difference will be added to storage. In months when allowable runoff exceeds expected runoff, water is discharged from storage.
13. Determine cumulative storage at the end of each month by adding the change in storage during one month to the accumulated quantity from the previous month. The computation should begin at the start of the wettest period. Cumulative storage cannot be less than zero.
14. The required storage volume is the largest value of cumulative storage. The storage volume must be adjusted for net gain or loss due to precipitation and evaporation (see Section 4.6.3).

If stored storm runoff does not meet the discharge permit concentration limits for regulated constituents, then the stored water must be reapplied to the OF system. The amount of stored storm runoff is expected to be small relative to the total volume of wastewater applied, and therefore, increases in slope area should not be necessary. The additional water volume can be accommodated by increasing the application period as necessary.

6.5.3 Storage for Equalization

From a process control standpoint it is desirable to operate an OF system at a constant application rate and application period. For systems that do not have storage facilities for other reasons, small equalizing basins can be used to even out flow variations that occur in municipal wastewater systems. A storage capacity of 1 day flow should be sufficient to equalize flow in most cases. The surface area of basins should be minimized to reduce intercepted precipitation. However, an additional half day of storage can be considered to hold intercepted precipitation in wet climates.

For systems providing only screening or primary sedimentation as preapplication treatment, aeration should be

provided to keep the basin contents mixed and prevent anaerobic odors. The added cost of aeration, in most cases, will be offset by savings resulting from reduced pump sizes and peak power demands. The designer should analyze the cost effectiveness of this approach for the system in question.

6.6 Distribution

Wastewater distribution onto OF slopes can be accomplished by surface methods, low pressure sprays, and high pressure impact sprinklers. The choice of system should be based on the following factors:

1. Minimization of operational difficulties, such as
 - Uneven wastewater distribution onto the slopes and the creation of short-circuiting and channeling
 - Solids accumulation at the point of application
 - Physical damage due to maintenance activities and freezing
2. Capital, operating, and energy costs

6.6.1 Surface Methods

Surface distribution methods include gated aluminum pipe commonly used for agricultural irrigation (Section 4.7.2), and slotted or perforated plastic pipe. Commercially available gated pipe can have gate spaces ranging from 0.6 to 1.2 m (2 to 4 ft) and gates can be placed on one or both sides of the pipe (see Figure 6-2). A 0.6 m (2 ft) spacing is recommended to provide operating flexibility. Slide gates rather than screw adjustable orifices are recommended for wastewater distribution. Gates can be adjusted manually to achieve reasonably uniform distribution along the pipe. However, the pipe should be operated under low pressure, 1.5 to 3.5 N/cm² (2 to 5 lb/in.²), to achieve good uniformity at the application rates recommended in Table 6-5, especially with long pipe lengths. Pipe lengths up to 520 m (1,700 ft) have been used, but shorter lengths are recommended. For pipe lengths greater than 100 m (300 ft), inline valves should be provided along the pipe to allow additional flow control and isolation of pipe segments for separate operation.

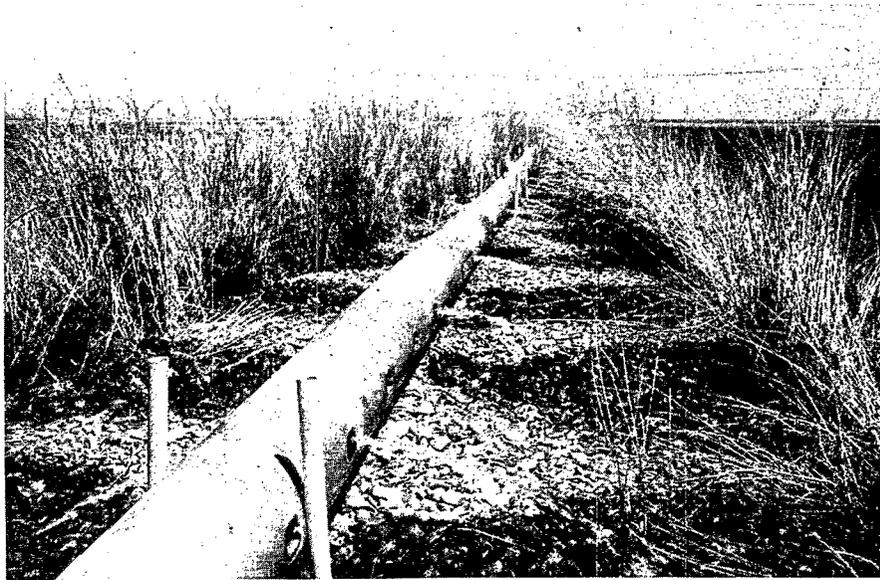

FIGURE 6-2
SURFACE DISTRIBUTION USING GATED PIPE FOR OF

Slotted or perforated plastic pipe have fixed openings at intervals ranging from 0.3 to 1.2 m (1 to 4 ft). These systems operate under gravity or very low pressure and the pipe must be level to achieve uniform distribution. Consequently, such methods should be considered only for small systems having relatively short pipe lengths that can be easily leveled.

The principal advantages of surface systems are low capital cost and low energy consumption and power costs. The major disadvantage with surface systems is the tendency of discharge orifices to accumulate debris and become partially plugged. Consequently, orifices must be inspected regularly and cleaned as necessary to maintain proper distribution. Another disadvantage of surface systems is the potential for deposition of solids at the point of application when treating wastewaters with high concentrations of suspended solids. Deposition problems have not been reported with surface distribution systems applying municipal wastewater, either screened raw or primary effluent, at conventional

hydraulic loading rates and application rates. However, solids buildup has occurred when applying food processing wastewater with solids concentrations >500 mg/L.

6.6.2 Low Pressure Sprays

Low pressure, 10 to 15 N/cm² (15 to 20 lb/in.²), fan spray nozzles mounted on fixed risers that distribute wastewater across the top of the slope have been used successfully with stabilization pond effluent (see Figure 6-3). However, experience using this method for screened raw wastewater has been mixed. Preapplication treatment with fine screens is essential for this method to be used with raw wastewater or primary effluent.



FIGURE 6-3
DISTRIBUTION FOR OF USING LOW PRESSURE FAN SPRAY NOZZLES

Low pressure fan nozzles mounted on rotating booms were used previously but found to require too much maintenance to be practical.

6.6.3 High Pressure Sprinklers

High pressure, 35 to 55 N/cm² (50 to 80 lb/in.²), impact sprinklers have been used successfully with food processing wastewaters containing suspended solids concentrations >500 mg/L. The position of the impact sprinkler on the slope depends on whether the sprinkler rotation is full-circle or half-circle and on the configuration of the slopes. Several possible sprinkler location configurations are illustrated in Figure 6-4. With configuration (a), slope lengths in the range of 45 to 60 m (150 to 200 ft) are required to prevent spraying into runoff channels and to provide some downslope distance beyond the spray pattern. Use of half-circle sprinklers, configurations (c) and (d), or full-circle sprinkler in configuration (b) allows the use of slope lengths less than 45 m (Section 6.4.6).

The spacing of the sprinkler along the slope depends on the design application rate and must be determined in conjunction with the sprinkler discharge capacity and the spray diameter. The relationship between OF application rate and sprinkler spacing and discharge capacity is given by the following equation:

$$q = \frac{(Q_s)(10^{-3} \text{ m}^3/\text{L})(3,600 \text{ s/h})}{(S_s)} \quad (6-7)$$

where q = OF application rate, m³/h·m

Q_s = sprinkler discharge rate, L/s

S_s = sprinkler spacing, m

The sprinkler spacing should allow for some overlap of spray diameters. A spacing of about 80% of the spray diameter should be adequate for OF. Using the design OF application rate and the above criteria for spray diameter, a sprinkler can be selected from a manufacturer's catalog. Sprinkler selection is discussed in Appendix E. Application rate can be adjusted by regulating the sprinkler operating pressure.

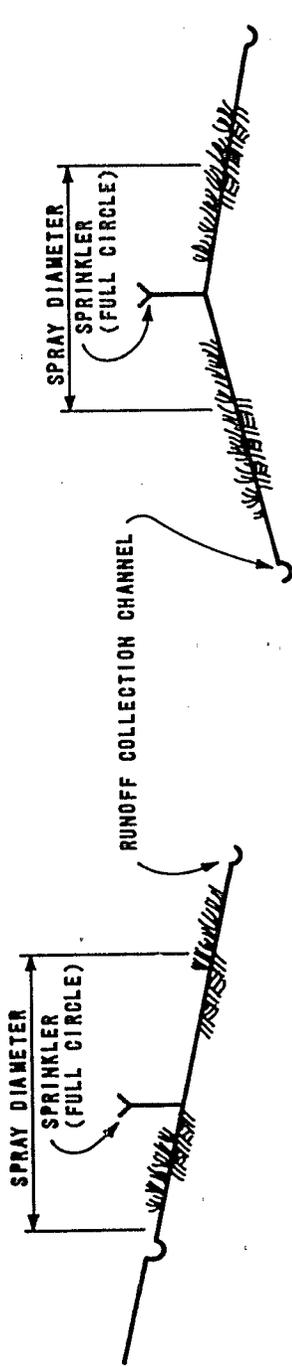

(a)

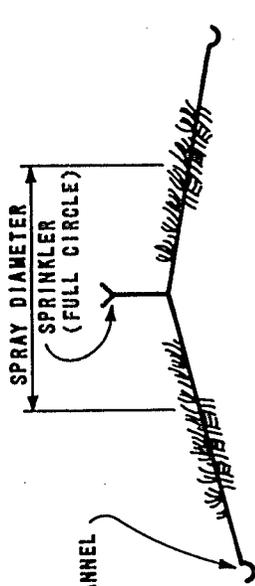

(b)

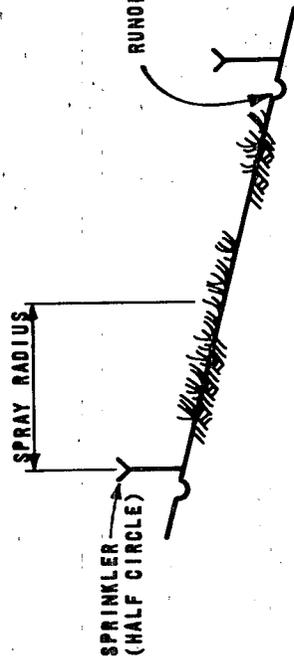

(c)

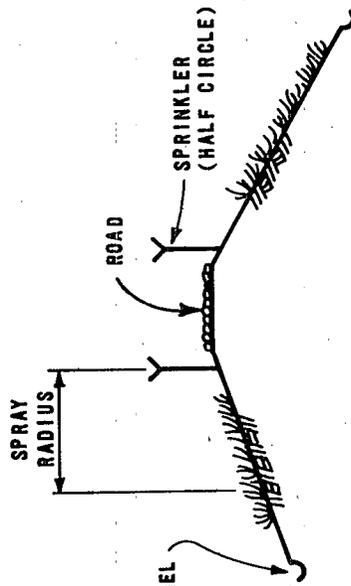

(d)

FIGURE 6-4
 ALTERNATIVE SPRINKLER CONFIGURATIONS
 FOR OVERLAND FLOW DISTRIBUTION

Sprinkler distribution systems are capable of providing a uniform distribution across the slope and distributing a high solids load over a large area to avoid accumulation. Operator attention requirements are expected to be less with sprinkler systems than with surface systems. Disadvantages associated with sprinkler distribution include relatively high capital costs, high energy requirements, and potential short-circuiting due to wind drift of sprays. Preapplication treatment must be sufficient to prevent nozzle clogging (Section 6.3).

6.6.4 Buried Versus Aboveground System

Low pressure sprays and sprinkler systems may have either aboveground or buried piping. Surface piping generally has a lower capital cost, but buried pipe has a longer service life and is not as susceptible to damage from freezing or harvesting equipment.

6.6.5 Automation

Both gravity and pressure distribution systems can be automated to any degree that is desired. The value of automation increases with the size of the system. The components required to effectively automate an OF system are relatively simple and trouble-free. Care should be exercised to avoid over-designing an automatic control system. The primary objective is to allow the operator to program any portion of the system to operate at any time for any length of time. Pneumatically or hydraulically operated diaphragm valves, tied into a centrally located control station, are commonly used. A clock-timer system coupled with a liquid level controller for the pumping system is usually adequate to provide a satisfactory control system.

6.7 Vegetative Cover

6.7.1 Vegetative Cover Function

A close growing grass cover crop is essential for efficient performance of OF systems. The cover crop serves the following functions in the process.

1. Erosion protection - crop provides surface roughness which acts to spread the water flow over the surface and reduces the velocity of surface flow thus helping to prevent channeling.
2. Support media for microorganisms - the biological slime layer that develops on the slope surface is supported by the grass shoots and vegetative litter.

3. Nutrient uptake - crop takes up nitrogen and phosphorus which can be removed by harvesting.

6.7.2 Vegetative Cover Selection

An OF cover crop should have the following characteristics: perennial grasses; high moisture tolerance; long growing season; high nutrient uptake; and suited for the local climate and soil conditions.

A mixture of grasses is generally preferred over a single species. The mixture should contain grasses whose growth characteristics compliment each other, such as sod formers and bunch grasses and species that are dormant at different times of the year. Another advantage of using a mixture is that, due to natural selection, one or two grasses will often predominate. One particular mixture which has been found to be quite successful is Reed canarygrass, tall fescue, redtop, dallisgrass, and ryegrass. In northern climates, substitution of orchardgrass for the redtop and dallisgrass is suggested. Although this mixture has proven effective in a variety of climates, it is always best to consult with a local agricultural advisor when selecting a seed mix to meet the criteria given above.

Salt sensitive plants, such as most varieties of clover, should be avoided. Pure stands of grasses whose growth characteristics are dominated by a single seed stalk such as Johnson grass, yellow foxtail, and most of the grains should be avoided. In the early stages of growth, these grasses provide a quick and effective cover. However, as the plant matures, the bottom leaves wither and disappear, leaving only the primary seed stalk which eventually produces the grain crop. When this happens, the value of these crops as OF cover vegetation is greatly reduced. Of course, crops having low moisture tolerance, such as alfalfa, should not be used.

6.8 Slope Construction

6.8.1 System Layout

The general arrangement of individual slopes should be such that gravity flow from the slopes to the runoff collection channels and finally to the main collection channels will be possible. A grading plan should be prepared that will minimize earthwork costs. Criteria for selecting slope grades are given in Section 6.4.7. From an operational standpoint, it is preferable to have the grading plan result in a single final discharge point. Occasionally, however, existing

terrain features will make a single point discharge impractical. In such cases, it is usually more cost effective to create multiple discharge points (and monitoring stations) rather than attempt to overcome the terrain constraints with extensive earthwork.

6.8.2 Grading Operations

Since the principle of smooth sheet flow down the slope is of critical importance to consistent OF process performance, appropriate emphasis must be placed on the proper construction of the slopes. Naturally occurring slopes, even if they are within the required length and grade range, seldom have the uniform overall smoothness required to prevent channeling, short-circuiting, and ponding. Therefore, it is necessary to completely clear the site of all vegetation and to regrade it into a series of OF slopes and runoff collection channels. The first phase of the grading operation is commonly referred to as rough grading and should be accomplished within a grade tolerance of 3 cm (0.1 ft). If a buried distribution system is being used, the rough grading phase is generally followed by the installation of the distribution piping and appurtenances.

After the slopes have been formed in the rough grading operation, a farm disk should be used to break up the clods, and the soil should then be smoothed with a land plane (see Figure 6-5). Usually, a grade tolerance of plus or minus 1.5 cm (0.05 ft) can be achieved with three passes of the land plane. Surface distribution piping may be installed at this stage.

Soil samples of the regraded site should be taken and analyzed by an agricultural laboratory to determine the amounts of lime and fertilizer that are needed. The appropriate quantities should then be added prior to seeding. A light disk should be used to eliminate any wheel tracks on the slopes as final preparation for seeding.

6.8.3 Seeding and Crop Establishment

It has been found that a Brillion seeder is capable of doing an excellent job of seeding the slopes. The Brillion seeder carries a precision device to drop seeds between cultipacker-typer rollers so that the seeds are firmed into shallow depressions, allowing for quick germination and protection against erosion. Hydroseeding may also be used if the range of the distributor is sufficient to provide coverage of the slopes so that the vehicle does not have to travel on the slopes. When seeding is completed, regardless of the means, there should be no wheel tracks on the slopes.

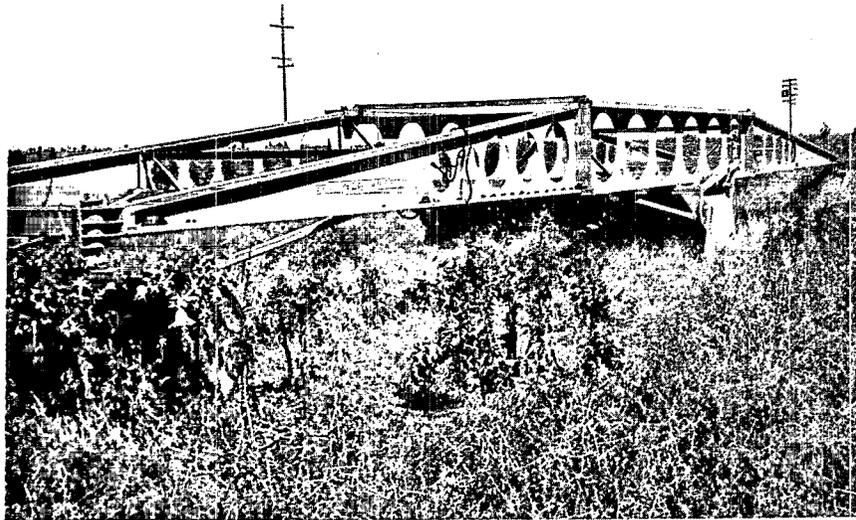

FIGURE 6-5
LAND PLANE USED FOR FINAL GRADING

It is important to establish a good vegetative cover prior to applying wastewater to the slopes. Good planning will minimize the effort and cost required to achieve this. The construction scheduling should be organized so that the seeding operation is accomplished during the optimum periods for planting grass in the particular project locality. This is generally sometime during the fall or spring of each year. During these periods, sufficient natural precipitation is often available to develop growth. In arid and semiarid climates or whenever seed is planted during a dry period, it may be necessary to irrigate the site with fresh water, if wastewater is unavailable, to establish the grass crop. In these cases, a portable sprinkler irrigation system should be used to provide irrigation water coverage over the entire slope area, since use of the OF distribution system would cause erosion of the bare slopes. It may be necessary to sow additional seed or to repair erosion that may occur as a result of heavy rains prior to the stabilization of the slopes.

As a general rule, wastewater should not be applied at design rates until the crop has grown enough to receive one cutting. Cut grass from the first cutting may be left on the slope to help build an organic mat as long as the

clippings are short (0.3 m or 1 ft); long clippings tend to remain on top of the cut grass thus shading the surface and retarding regrowth.

6.9 Runoff Collection

The purpose of the runoff collection channels is to transport the treated runoff and storm runoff to a final discharge point and allow runoff to flow freely off the slopes. The collection channels are usually vegetated with the same species of grasses growing on the slopes and should be graded to prevent erosion. There are some cases, however, where additional construction is necessary. Sharp bends or steep grades along runoff channels will increase the potential for erosion, and it may be necessary to provide additional protection in the form of riprap, concrete, or other stabilizing agent at these points. Runoff channels should be graded to no greater than 25% of the slope grade to prevent cross flow on the slope.

In humid regions, particularly where the topography is quite flat and the runoff channels have small grades, grass covered channels may not dry out entirely. This may increase channel maintenance problems and encourage mosquito populations. In these cases, concrete or asphalt can be used or a more elaborate system involving porous drainage pipe lying in the channel beneath a gravel cover. It should be emphasized, however, that it is usually not necessary to go to these lengths to obtain free-flowing yet erosion-protected runoff channels. Small channels are normally V-shaped, while major conveyance channels have trapezoidal cross-sections.

In addition to transporting treated effluent to the final discharge point, the runoff channels must also be capable of transporting all stormwater runoff from the slopes. The channels should be designed, as a minimum, to carry runoff from a storm with a 25 year return frequency. Both intensity and duration of the storm must be considered. A frequency analysis of rainfall intensity must be performed and a rainfall-runoff relationship developed to estimate the flowrate due to storm runoff that must be carried in the channels. The local SCS office can provide assistance in performing this design. References [12, 13] can also be consulted. In some cases, it may be desirable to provide a perimeter drainage channel around the OF site to exclude offsite stormwater from entering the OF drainage channels.

6.10 System Monitoring and Management

The primary objective of the OF system is to produce a treated effluent that is within the permit requirements. Therefore, a monitoring program and a preventive maintenance program are necessary to ensure continued compliance with discharge requirements.

6.10.1 Monitoring

6.10.1.1 Influent and Effluent

The influent and effluent monitoring requirements will usually be dictated by the discharge permit established for the system by the regulatory authorities. An open channel flow measuring device (Parshall flume, weir, etc.) equipped with a continuous flow recorder is generally satisfactory for monitoring the treated effluent. Most types of portable or permanent automatic samplers can be used for sampling.

6.10.1.2 Ground Water

The need to install ground water monitoring wells will generally be determined by the regulatory authorities. In certain cases, the authorities will also establish the number and location of monitoring wells. If those decisions are left to the designer, however, it is advisable to consider a minimum of two ground water monitoring wells, one located upstream of ground water movement through the treatment site which will serve as a background well, and the second immediately downstream from the site to show any impacts from the treatment operation.

6.10.1.3 Soils and Vegetation

Suggested monitoring programs for soils and vegetation given in Sections 4.10.2 and 4.10.3 for SR systems are also applicable to OF systems. If the vegetation on the treatment site is harvested and used for fodder, samples may be taken at each harvest and analyzed for various nutritive parameters such as percent protein, fiber, total digestible nutrients, phosphorus, and dry matter.

6.10.2 System Management

6.10.2.1 Operation and Maintenance

Process control involves regulating the distribution system to provide design application rates and application periods, and adding water to and releasing water from storage at the

appropriate times (see Section 6.4 and 6.5). A routine operation and maintenance schedule should be followed including a daily inspection of system components (pumps, valves, sprinklers, distribution orifices on surface systems, flowmeters). Application rates and periods should be checked and maintained within design limits.

6.10.2.2 Crop Management

After the cover crop has been established, the slopes will need little, if any, maintenance work. It will, however, be necessary to mow the grass periodically. A few systems have been operated without cutting, but the tall grass tends to interfere with maintenance operations. Normal practice has been to cut the grass two or three times a year. As mentioned previously, the first cutting may be left on the slopes. After that, however, it is desirable to remove the cut grass. The advantages of doing so are that additional nutrient removal is achieved, channeling problems may be more readily observed, and revenue can sometimes be produced by the sale of hay. Depending on the local market conditions, the cost of harvesting can at least be offset by the sale of hay.

Slopes must be allowed to dry sufficiently such that mowing equipment can be operated without leaving ruts or tracks that will later result in channeling of the flow. The drying time required before mowing varies with the soil and climatic conditions and can range from a few days to a few weeks. The downtime required for harvesting can be reduced by a week or more if green-chop harvesting is practiced instead of mowing, raking, and baling. However, local markets for green-chop must exist for this method to be feasible.

It is common for certain native grasses and weeds to begin growing on the slopes. Their presence usually has little impact on treatment efficiency and it is generally not necessary to eliminate them. However, there are exceptions and the local extension services should be consulted for advice.

Proper management of the slopes and the application schedule will prevent conditions conducive to mosquito breeding. Other insects are usually no cause for concern, although an invasion of certain pests such as army worms may be harmful to the vegetation and may require periodic insecticide application.

6.11 Alternative Design Methods

Recently, two rational methods have been developed for determining OF design criteria. One, based on detention time on the slope, was developed at the U.S. Army Cold Regions Research and Engineering Laboratory (CRREL) [14]. The other, based on slope distance and application rate was developed at the University of California, Davis [15]. Both approaches have been validated with results from other studies and have been used for preliminary or pilot scale design of OF systems. A design example comparing the traditional empirical approach with these two methods can be found in Appendix C.

6.11.1 CRREL Method

6.11.1.1 Method Description

The basis of the CRREL method is a relationship between detention time and mass BOD reduction using performance data from the CRREL system, and validated with data from the Utica and University of California, Davis, systems. With this relationship, the required detention time can be calculated for a specified mass BOD reduction. This detention time is then used in an equation which relates detention time, slope length, and slope grade to application rate. Thus, for an OF slope with a given length and grade, the required application rate can be determined for a specified detention time or, indirectly, for a specified BOD reduction. The application rate is then used to calculate the required land area.

6.11.1.2 Design Procedure

1. Calculate detention time.

The relationship between detention time and mass BOD reduction is expressed as:

$$E = (1 - Ae^{-Kt})100 \quad (6-8)$$

where E = percent mass BOD removal

A = nonsettleable fraction of BOD in applied wastewater (constant = 0.52)

K = average kinetic rate constant (0.03 min⁻¹)

t = detention time, min

2. Calculate average OF rate.

The average OF rate needed to obtain this required detention time is calculated using the following equation:

$$q = (0.078S)/(G^{1/3}t) \quad (6-9)$$

where q = average OF flowrate ($q_{\text{applied}} + q_{\text{runoff}}$)/2,
m³/h·m of slope width

S = length of section, m

G = slope of section, m/m

t = detention time, min

To use Equation 6-9, section length (S) and section slope (G) must first be determined by an investigation of the proposed site. This investigation should yield a section with length and width dimensions and with a specific section slope which will be used when determining area requirements. Actually, more than one section size can be selected if the topography of the site is such that less land forming would be required if the site were not composed of uniform sections. Equation 6-9 would then be used with the parameters from each section to determine the average OF rate for each section.

3. Calculate application rate.

The following equation is used to determine the application rate for each section:

$$Q = qw/r \quad (6-10)$$

where Q = application rate, m³/h per section

q = average OF flowrate [$q_{\text{applied}} + q_{\text{runoff}}$]/2, m³/h·m

w = width of section, m

r = (1.0 + runoff fraction)/2

The runoff fraction is the fraction of the applied wastewater which reaches the runoff collection ditches. The runoff fraction must be assumed in order to use Equation 6-10. The runoff fraction ranges from 0.6 to 0.9

depending on the permeability of the soil and evaporation losses.

4. Calculate annual loading rate.

The annual loading rate (m^3/yr) must be determined for each section. To do this, the number of days of application per year must be calculated and the application period must be selected. Given these values and the loading rates, the annual loading rates for each section can be calculated.

5. Calculate total annual water volume.

An estimate of the volume of precipitation minus evapotranspiration that will collect in the storage or preapplication treatment basin must be made and added to the annual wastewater volume to obtain the total annual water volume.

6. Calculate land area requirements.

The number of sections are calculated using the total annual water volume and annual application rate to each section. However, the number of sections of a particular size may be determined by physical constraints at the site. The land requirement is now calculated by multiplying the number of sections of each particular size by its area.

6.11.2 University of California, Davis, (UCD) Method

6.11.2.1 Method Description

The basis for the UCD method is a model which describes BOD removal as a function of slope length and application rate, where the application rate has the units $m^3/h \cdot m$ of slope width. This model was developed using performance data from the UCD system and was substantiated using data from the CRREL system. By knowing the influent BOD requirements, the model can predict either the required slope length or application rate, once the other parameter has been fixed. Once both parameters are known and a design daily flowrate is given, the area requirements can be determined.

6.11.2.2 Design Procedure

1. Determine slope length or application rate.

Either slope length or application rate can be calculated, once the other parameter has been fixed, using the following equation:

$$C_s/C_o = Ae^{[(-KS)/(q^n)]} \quad (6-11)$$

where C_s = concentration BOD at point S, mg/L
 C_o = initial BOD concentration, mg/L
 A = constant = 0.72
 K = rate coefficient (constant = 0.01975 m/h)
 S = distance downslope, m
 q = application rate, $m^3/h \cdot m$ slope width
 n = exponent (constant = 0.5)

Site conditions may dictate the allowable slope length, in which case slope length would be the independent parameter and application rate would be the computed parameter. If slope length is not restricted, then application rate should be used as the independent parameter. Currently, the model is valid in the range of 0.08 to 0.24 $m^3/h \cdot m$ and so the application rate selected for a design should be within this range.

The effect of water loss due to evaporation and percolation is incorporated into the rate coefficient (K). Significant changes in the value of K are not expected as a result of changes in water losses normally experienced with OF systems. Additional field testing is necessary to confirm this.

2. Select an application period.

See Section 6.4.4 for a discussion on selecting an application period.

3. Compute the average daily flow to OF system.

To compute the average daily flowrate, the application season (days of application per year) must be calculated. Also, the volume of precipitation minus evapotranspiration that will collect in the storage basin or preapplication treatment basin must be estimated. With this information and the average daily wastewater flowrate, the average daily flow to the OF system can be calculated.

4. Compute the required wetted area.

The wetted area is computed using the following equation:

$$\text{Area} = QS/qP \quad (6-12)$$

where Q = average daily flow to the OF system, m^3/d
 S = slope length, m
 q = application rate, $m^3/h \cdot m$
 P = application period, h/d

6.11.3 Comparison of Alternative Methods

Although the CRREL and UCD equations appear different, the basic approach and calculation method are quite similar. Combining and rearranging Equations 6-8 and 6-9 from the CRREL method produces:

$$M_S/M_O = 0.52e^{(-0.00234S)/(G^{1/3}q)} \quad (6-13)$$

where M_S = mass of BOD at point S, kg
 M_O = mass of BOD at top of slope, kg
 S = slope length, m
 G = slope grade, m/m
 q = average overland flow, $m^3/h \cdot m$

This is quite similar to the UCD Equation 6-11:

$$C_S/C_O = 0.72e^{(-0.01975S/q^{0.5})} \quad (6-14)$$

All terms are defined previously.

The major differences in these two rational approaches are:

1. Use of slope grade as a variable in CRREL equation and not in UCD equation.
2. Use of mass units in CRREL equation and concentration units in UCD equation.
3. Value of exponents and coefficients.

6.12 References

1. Bledsoe, B.E. Developmental Research for Overland Flow Technology. In: Proceedings of the National Seminar on Overland Flow Technology, Dallas, Texas. U.S. Environmental Protection Agency. EPA-600/9-81-022. September 1980.
2. Hall, D.H., et al. Municipal Wastewater Treatment by the Overland Flow Method of Land Application. Environmental Protection Agency. EPA-600/2-79-178. August 1979.
3. Pollock, T.E. Design and Operation of Overland Flow Systems - The Easley Overland Flow Facility. Proceedings of Workshop on Overland Flow for Treatment of Municipal Wastewater. Clemson University. Clemson, South Carolina. June 1980.
4. Martel, C.J., et al. Wastewater Treatment in Cold Regions by Overland Flow. CRREL Report 80-7. U.S. Army Corps of Engineers. Hanover, New Hampshire. 1980.
5. Martel, C.J., et al. Development of a Rational Design Procedure for Overland Flow Systems. CRREL, U.S. Army Corp of Engineers, Hanover, New Hampshire. (In preparation). December 1981.
6. Scott, T.M. and D.M. Fulton. Removal of Pollutants in the Overland Flow (Grass Filtration) System. Progress in Water Technology, Vol. 11, Nos. 4 and 5. pp 301-313. 1979.
7. Peters, R.E., C.R. Lee, and D.J. Bates. Field Investigations of Overland Flow Treatment of Municipal Lagoon Effluent. U.S. Army Engineer Waterways Experiment Station, Vicksburg, Massachusetts. (In preparation).
8. Smith, R.G. Development of a Rational Basis for the Design of Overland Flow Systems. In: Proceeding of the National Seminar on Overland Flow Technology. Dallas, Texas. U.S. Environmental Protection Agency. EPA-600/9-81-022. September 1980.
9. Thomas, R.E., et al. Overland Flow Treatment of Raw Wastewater with Enhanced Phosphorus Removal. USEPA, Office of Research and Development. EPA-660/2-76-131. 1976.

10. Peters, R.E., et al. Field Investigations of Advanced Treatment of Municipal Wastewater by Overland Flow. Volume 2. Proceedings of the International Symposium on Land Treatment of Wastewater. Hanover, New Hampshire. August 1978.
11. Law, J.P., et al. Nutrient Removal from Cannery Wastes by Spray Irrigation of Grassland. Water Pollution Control Research Series, 16080-11/69. U.S. Department of the Interior. Washington, D.C. November 1969.
12. U.S. Dept. of Commerce. Rainfall Frequency Atlas of the United States for Durations from 30 minutes to 24 hours and Return Periods from 1-100 Years. Technical Paper 40. 1961.
13. Water Resources Council. A Uniform Technique for Determining Flood Flow Frequencies. Bulletin No. 15. 1967.
14. Martel, C.J. et al. Rational Design of Overland Flow Systems. Proceedings of the ASCE National Conference of Environmental Engineering. July 1980.
15. Smith, R.G. Development of a Predictive Model to Describe the Removal of Organic Material with the Overland Flow Treatment Process. Ph.D. Thesis. University of California, Davis. 1980.

CHAPTER 7

SMALL SYSTEMS

7.1 Introduction

The procedures in this chapter are intended primarily for systems with wastewater flows of $950 \text{ m}^3/\text{d}$ (250,000 gal/d) or less, but, in some situations, may be used for flows up to $3,785 \text{ m}^3/\text{d}$ (1 Mgal/d). The objectives for land treatment systems are the same regardless of the community size. However, the design of small systems should include special emphasis on the ease of operation and on minimizing construction and operating costs. Most communities in this size range cannot hire full-time treatment plant operators, and the treatment system must be capable of providing consistent, reliable treatment in the absence of frequent attention. In general, most treatment systems that meet these objectives are nonmechanical and have no discharge to surface waters.

The procedures described in this chapter can be used to streamline Phase 1 of the planning process. Limited field work should be conducted during Phase 2 to verify Phase 1 assumptions and to optimize design criteria, particularly when designing RI systems. When more detailed planning or design procedures are needed, the engineer should refer to Chapters 4, 5, and 6.

7.2 Facility Planning

The procedures for planning and design of small systems are similar to, but less detailed than, the requirements for large facilities. Maximum use is made of local expertise and existing published information. The area Soil Conservation Service (SCS) staff, the county agent, and local farmers can all provide assistance and advice. The types of information that should be obtained from these local or published sources are summarized in Table 7-1. The level of detail and the period over which data have been recorded will vary with the community.

7.2.1 Process Considerations

Any of the three major land treatment processes (SR, RI, and OF) or combinations of these processes are suitable for small communities. Seepage ponds have been used successfully in many small communities and are similar to RI in that relatively high hydraulic loading rates are used and treatment occurs as wastewater percolates through the

soil. The primary difference is that seepage ponds are loaded continuously, whereas RI systems use a loading cycle that includes both application and drying periods, resulting in improved treatment and maximum long-term infiltration rates. Other processes, including complete retention and controlled discharge pond systems, also have potential for small communities. Information on these pond systems can be found in the EPA Process Design Manual for Wastewater Treatment Ponds [1].

TABLE 7-1
 TYPES AND SOURCES OF DATA REQUIRED FOR DESIGN
 OF SMALL LAND TREATMENT SYSTEMS

Type of data	Principal sources
Wastewater quantity and quality	Local wastewater authorities
Soil type and permeability	SCS soil survey
Temperature (mean monthly and growing season)	SCS soil survey, NOAA, local airports, newspapers
Precipitation (mean monthly, maximum monthly)	SCS soil survey, NOAA, local airports, newspapers
Evapotranspiration and evaporation (mean monthly)	SCS soil survey, NOAA, local airports, newspapers, agricultural extension service
Land use	SCS soil survey, aerial photographs from the Agricultural Stabilization and Conservation Service, and county assessors' plats
Zoning	Community planning agency, city or county zoning maps
Agricultural practices	SCS soil survey, agricultural extension service, county agents
Surface and ground water discharge requirements	State or EPA
Ground water (depth and quality)	State water agency, USGS, drillers' logs of nearby wells

Design features, site characteristics, and renovated water quality of the three major land treatment processes are summarized in Tables 1-1, 1-2, and 1-3. General characteristics of small land treatment systems are summarized in Table 7-2. This table should be used as a guide to process selection. Final criteria should be determined during facilities design.

7.2.1.1 Operation and Ownership Alternatives

Small systems may be owned and operated by a municipality or wastewater authority, although municipal ownership and operation are not always necessary. In all cases, overall system management should be under the control of the municipal agency held responsible for performance. Opportunities often exist, and should be sought, for contractual

agreements with local farmers to take and use partially treated wastewater for irrigation and other purposes. By taking advantage of such agreements, a community can avoid investments in equipment and land, and can eliminate the need to hire and train new employees.

TABLE 7-2
GENERAL CHARACTERISTICS OF SMALL
($<950 \text{ m}^3/\text{d}$ OR $<250,000 \text{ gal/d}$) LAND TREATMENT SYSTEMS

Process	Minimum preapplication treatment	Crops	Application season	Application schedule	Storage requirements
Slow rate	Primary	Annuals	Growing season (3-5 months)	8 h, 1 d/wk	See Figure 2-5
Surface application		Perennials or double cropping	Year-round with exception of downtime for planting, harvesting, maintenance, and cold-weather storage if necessary	8 h, 1 d/wk	See Figure 2-5
Sprinkler application	Ponds				
Rapid infiltration	Primary	Not applicable	Year-round	2 d application, 10-18 d drying	7-30 d for emergencies
Overland flow	Screening and comminution	Perennial grasses	Year-round with exception of downtime for planting, harvesting, maintenance, and cold-weather storage if necessary	8-12 h/d, 5-7 d/wk	See Figure 2-5

Arrangements between local farmers and communities can involve any of several alternatives. For example, the community can provide partially treated wastewater to a farmer, who is then responsible for all components of the land treatment process. Alternatively, the community may provide and maintain irrigation equipment that is used by a farmer who is responsible for all farming operations. In either case, the farmer agrees to take a predetermined amount of water each year to use on his own land. A third alternative is for the community to purchase or lease land and equipment for land treatment and assume responsibility for all aspects of the system except planting, cultivating, and harvesting. These three tasks are accomplished by the local farmer on a contractual or crop sharing basis.

Land used for wastewater application either can be purchased outright (fee-simple acquisition) or leased on a long-term basis. Long-term leases should include the items summarized in Table 2-15. Grant eligible costs of a long-term lease are paid to the community in a lump sum at the beginning of the leasing term.

Contractual arrangements between local farmers and communities should specify the following:

- The duration of the agreement.
- Projected quality of water that will be delivered to farmers.
- Any limits on application rates, buffer zones, or runoff control.
- Any limitations on crop types due to local or state requirements.
- Cost to local farmer and/or community.
- Method and timing of payments (generally annual).
- Method of transferring contract.

Arrangements between local farmers and communities are most practical when forage grasses or grazing animals are involved, since there is less constraint on application of wastewater in years of high rainfall. Other agricultural crops with shorter growing seasons or which are less water tolerant than forage grasses may require additional storage or other considerations. Most arrangements have involved SR systems. Overland flow systems normally are owned by the community to ensure control over system operation. However, contract harvest of OF grasses is advantageous in communities that lack the necessary equipment and expertise.

Rapid infiltration systems also tend to be municipally owned and operated to ensure control over the wastewater treatment process. No crops are involved; thus, the only potential agreements between farmer and community are for land leasing, property easements, or use of recovered water.

7.2.1.2 Water Rights Considerations

In the western states, water rights must be considered. Return of renovated water, including OF runoff and SR and RI percolate, to the original point of community discharge may be necessary. Sometimes, RI basins can be located so that seepage and subflow proceed directly to the stream or water body (Figure 1-2c; Section 5.7.1) that received discharge from the previous system. The local water rights situation should be checked with the state agency in charge.

7.2.1.3 Preapplication Treatment

Most land treatment systems include a preapplication treatment step. In small communities, wastewater storage often is provided in the preapplication treatment process. The use of existing treatment facilities may reduce the capital cost of a land treatment system but may necessitate construction of separate storage facilities.

Preapplication treatment facilities should be as close to the application site as the topography, land availability, and system objectives allow. Most existing treatment facilities serving small communities are located at a relatively low elevation to allow a gravity sewer system. Thus, if existing facilities are used, it probably will not be possible to locate the application site near the preapplication treatment system. Instead, it is often necessary to pump the partially treated wastewater to the application site.

7.2.1.4 Staffing Requirements

Staffing requirements depend on the types of preapplication treatment and land treatment, the size of the system, and whether the community or a farmer operates the land treatment portion of the system. Staffing requirements for municipally owned and operated systems are presented in Figure 2-9. Staffing requirements at a variety of smaller systems are shown in Table 7-3.

7.2.2 Site Selection

Before a community can begin the site selection process, it must be able to estimate the amount of land that a land treatment system will require. Approximate land area requirements have been plotted as a function of average design flow for each of the three major types of land treatment in Figure 7-1. Although land area estimates are shown only for flows of $950 \text{ m}^3/\text{d}$ (250,000 gal/d) or less, land requirements for flows of up to $3,785 \text{ m}^3/\text{d}$ (1 Mgal/d) can be extrapolated from the curves.

In addition, for SR application periods between 6 and 12 months per year, land area requirements can be interpolated from the two SR curves. For OF application periods greater than or less than 10.5 months per year and RI application periods less than 12 months per year, land area requirements can be extrapolated from the OF and RI curves, respectively. Figure 7-1 can be used to determine what size site to search for during the site selection process, but should not be used for design purposes. Final land

requirements will vary with the crop grown, site characteristics, and whether the site is operated by the community or a local farmer.

TABLE 7-3
TYPICAL STAFFING REQUIREMENTS
AT SMALL SYSTEMS

Location	1980 flow		Site use	Site control	Municipal staff requirements		
	m ³ /d	gal/d			Pre-application components, man-days/yr	Land treatment components, man-days/yr	Annual total, man-days
Chapman, Nebraska	66	17,400	Grass (RI)	City	--	--	<165 ^a
Falkner, Mississippi	106	28,000	Grasses (OF)	City	<89	<93	<182
Kennett Square, Pennsylvania	190	50,000	Forest	City	130	68	198
Ravenna, Michigan	275	72,000	Open, un-cultivated fields	City	68	7	75
Santa Anna, Texas	285	75,000	Alfalfa, grass, pasture	Farmer owns, city operates equipment	54	46	100
Wayland, Michigan	950	250,000	Hay, corn	City owns, farmer harvests	104	68	172
Winters, Texas	1,130	297,000	Hay	Farmer owned	52	0	52

Note: Preapplication treatment by ponds.

a. Includes labor spent maintaining three pumping stations in collection system.

The site selection process can be divided into parts: site identification and site screening (Sections 2.2.4 and 2.2.5). In small communities, the first step in identifying potential land treatment sites is to determine whether any of the local farmers are willing to participate in a land treatment project or are interested in selling or leasing property for a land treatment site. Questionnaires and meetings with local groups can be particularly helpful when making this determination. If one or more farmers are interested in participating and have enough land to take and use the wastewater, or are interested in selling or leasing enough property for a land treatment site, site investigation can begin. If the local farmers are not interested or if the interested farmers do not have enough suitable land, it will be necessary to identify and screen potential sites using existing soils, topographical, hydrogeological, and land use data. The identification and

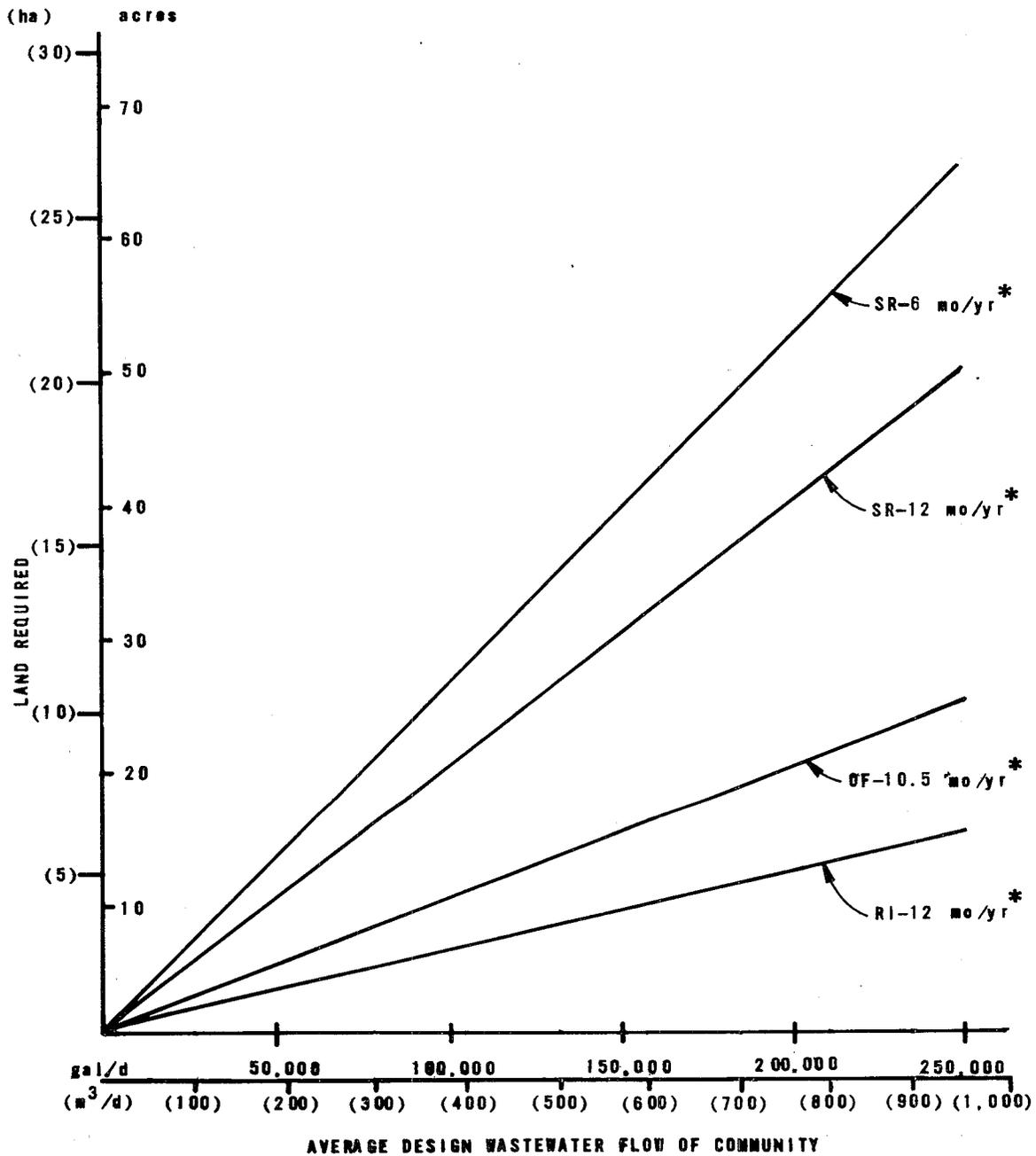

* NUMBER OF MONTHS PER YEAR THAT WASTEWATER IS APPLIED TO LAND.

FIGURE 7-1
LAND AREA ESTIMATES FOR PRELIMINARY PLANNING PURPOSES
(INCLUDING LAND FOR PREAPPLICATION TREATMENT)

screening processes are detailed in Chapter 2; only the highlights are presented in this chapter.

As discussed in Section 2.2.4, existing data can be used to classify broad areas of land near the community according to their land treatment suitability. Factors that should be considered include current and planned land use, parcel size, topography, present vegetative cover, susceptibility to flooding, soil texture, geology, distance from the area where wastewater is generated, and need for underdrainage (based on recommendations of local SCS representative). Generally, the characteristics of the closest suitable site will greatly influence the selection of the land treatment system type to be designed. The detailed rating factor approach in Chapter 2 is usually unnecessary because economics will limit the number of sites that can be considered.

7.2.3 Site Investigations

As in larger communities, field investigations are conducted to verify any data used to select sites and to verify overall land treatment suitability. However, the level of effort needed to conduct site investigations in smaller communities is much lower. In smaller communities, it is more practical to conduct minimal field investigations and assume relatively conservative design criteria than to complete the extensive and expensive investigations needed to pinpoint optimal design criteria.

Generally, soils information available from the area SCS office and limited field observations will yield sufficient information for most SR and OF system designs. The first step in the site investigation procedure should be to visit the potential site with a local SCS representative. The primary purpose of these site visits is to confirm the data used to identify and select suitable sites. A few, shallow, hand-auger borings to identify the soil profile should be conducted to confirm the SCS data and check for impermeable layers or shallow ground water. Infiltration tests (see Section 3.4.1) are usually only needed for RI sites. For RI sites, a few backhoe pits to 3 m (10 ft) or more are also recommended, but drill holes are usually deferred until preliminary design.

If crops will be grown, a site visit with the county agent or local agricultural or forestry advisor is recommended. The purpose of this site visit is to obtain advice on the type of crops to use and on crop management practices.

7.3 Facility Design

Because only limited field investigations are conducted in small communities, it is important to use conservative design criteria. The application schedules and storage requirements presented in Table 7-2 are examples of conservative criteria. Other design criteria that must be identified include the level and type of preapplication treatment and storage, the land area required, wastewater loading rates and schedules, and pumping needs and other mechanical details. Land area requirements are estimated during the planning process and are refined as the hydraulic loading rate, method of preapplication treatment, and storage requirements are defined more precisely.

7.3.1 Preapplication Treatment and Storage

EPA guidance on minimum levels of preapplication treatment is summarized in Table 7-4.

TABLE 7-4
RECOMMENDED LEVEL OF
PREAPPLICATION TREATMENT

Type of land treatment	Situation	Recommended preapplication treatment
Slow rate	Isolated location; restricted public access; crops not for human consumption.	Primary.
	Controlled agricultural irrigation; crops not to be eaten raw by humans.	Biological (ponds or in-plant processes) with control of fecal coliforms to <1,000 MPN/100 mL.
	Public access areas such as parks, golf courses.	Biological (ponds or in-plant processes) with disinfection to log mean fecal coliforms of ≤ 200 MPN/100 mL.
Rapid infiltration	Isolated location; restricted public access.	Primary.
	Urban location; controlled public access.	Biological (ponds or in-plant processes).
Overland flow	Isolated site; no public access.	Screening or comminution.
	Urban location; no public access.	Screening or comminution with aeration to control odors during storage or application.

In small communities, ponds are usually the most practical form of preapplication treatment and storage. They are relatively easy to operate, require minimal maintenance, are less expensive than many types of treatment, and eliminate the need for separate storage facilities. Although some communities will want to use or upgrade other existing

facilities for use as preapplication treatment facilities, many small communities will find it advantageous to convert to pond systems because of their consistency, reliability, flexibility, ease of operation and maintenance, and cost.

Generally, ponds are constructed with one to three cells. In a three-cell system, the first cell is usually small and may be aerated to control odors. Alternatively, if sufficient land is available, the first cell may be designed as a facultative cell with a BOD loading of about 120 kg/ha·d (107 lb/acre·d). The water level in this cell is usually constant and can be controlled with an adjustable overflow weir or a gated manhole. The final cells can be used for storage and flow equalization. For this reason, these two cells are made as deep as possible. Typical design parameters for several types of ponds are presented in Table 7-5.

TABLE 7-5
TYPICAL DESIGN PARAMETERS FOR SEVERAL
TYPES OF PONDS [2]

	Aerobic	Facultative	Anaerobic
Pond size (individual cells), ha	<4	1-4	0.2-1
Detention time, d	10-40	7-30	20-50
Depth, m	1-1.5	1-2.5	2.5-5
BOD ₅ loading, kg/ha·d	40-120	15-200	200-500
BOD ₅ removed, %	80-95	80-95	50-85
Effluent suspended solids, mg/L	80-140	40-100	80-160

1 ha = 2.47 acres

1 m = 3.28 ft

1 kg/ha·d = 0.893 lb/acre·d

An additional benefit of using ponds is that the long detention times (30 days or more) promote nitrogen removal and pathogen inactivation. Preliminary models to estimate nitrogen and bacterial removals in ponds are given in Section 4.4.1.

7.3.2 Hydraulic Loading Rates

The first step in designing the land treatment portion of the system is to select a hydraulic loading rate. As an initial assumption, the hydraulic loading rate for SR and RI

systems is based on the most limiting SCS permeability classification of the soils at the selected site. Hydraulic loading rates that may be used in each of the three major types of land treatment systems have been plotted as a function of SCS permeability classification in Figures 7-2 and 7-3. Both figures represent average hydraulic loading rates. In Figures 7-2 and 7-3, whenever a range of loading rates is given, the lower end of the range should be used for primary effluents, the mid zone for pond effluents, and the upper portion of the range for secondary effluent. Lower loading rates than shown in Figures 7-2 and 7-3 can be used but will require more land. If OF is used to polish trickling filter or activated sludge effluent, loading rates of 30 to 40 cm/wk (12 to 16 in./wk) can be used.

Loading rates at SR and RI systems that overlies potential drinking water aquifers may be limited by nitrogen loading rather than soil permeability. At these systems, the ground water concentration of nitrate is limited to 10 mg/L as nitrogen at the project boundary (or the background nitrate concentration, if it is greater than 10 mg/L). Rapid infiltration systems should not be located above drinking water aquifers unless thorough field testing is conducted to verify that the nitrate standard can be met or unless the renovated water will be recovered (Sections 5.4.3.1 and 5.7).

7.3.2.1 Slow Rate

For SR systems located above drinking water aquifers, the following equation should be used to calculate the maximum allowable nitrogen loading rate based on nitrogen limits:

$$L_w(n) = \frac{C_p(Pr - ET) + 10U}{(1 - f)(C_n - C_p)} \quad (7-1)$$

where $L_w(n)$ = wastewater hydraulic loading rate based on nitrogen limits, cm/yr (in./yr)

C_p = percolate nitrogen concentration, mg/L = 10 mg/L

Pr = precipitation rate, cm/yr (in./yr)

ET = evapotranspiration rate, cm/yr (in./yr)

U = crop nitrogen uptake rate, kg/ha·yr (lb/acre·yr)

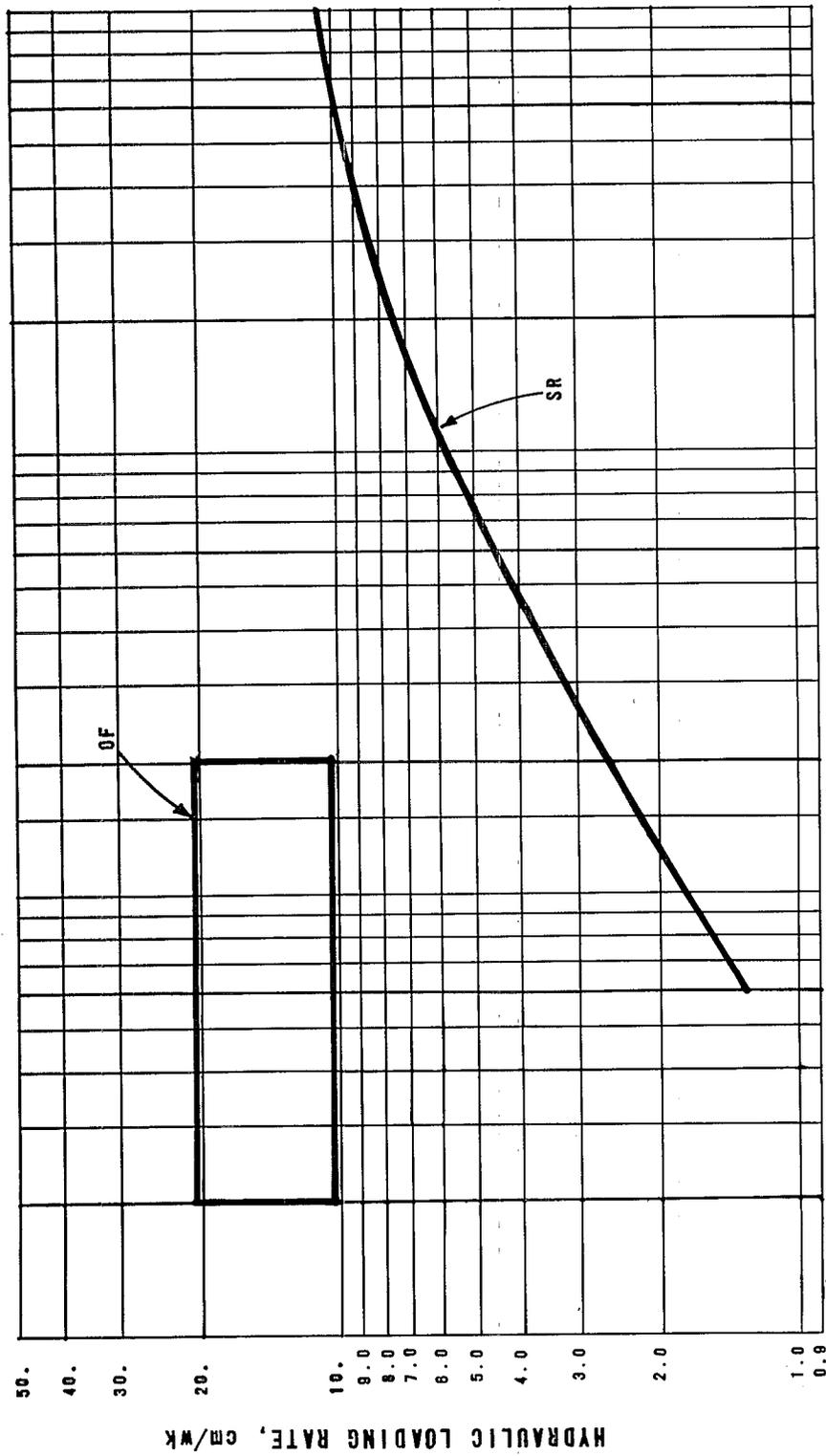

CLEAR WATER PERMEABILITY OF MOST LIMITING SOIL LAYER

in./h	< 0.06	0.06-0.2	0.2-0.6	0.6-2.0	2.0-6.0	6.0
cm/h	< 0.15	0.15-0.51	0.51-1.5	1.5-5.1	5.1-15	15

FIGURE 7-2
TYPICAL ANNUAL HYDRAULIC LOADING RATE OF SMALL SR AND OF SYSTEMS

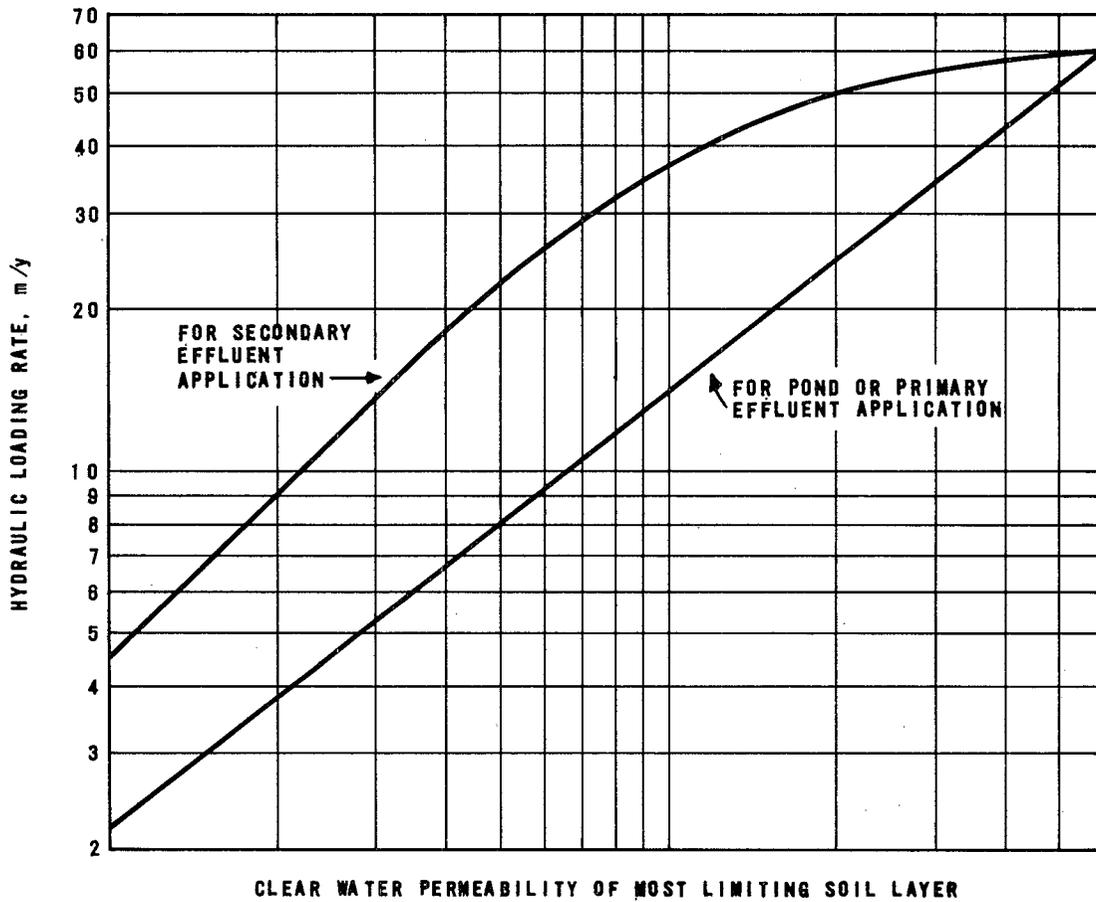

in./h	< 2.0	2-6	6-20	> 20
cm/h	< 5.1	5.1-15	15-51	> 51

FIGURE 7-3
TYPICAL ANNUAL HYDRAULIC LOADING RATE OF SMALL RI SYSTEMS

f = fraction of applied nitrogen removed by volatilization, denitrification, and storage = 0.15

C_n = nitrogen concentration in applied wastewater, mg/L

Conservative values should be assumed for nitrogen losses and crop uptake rates to ensure adequate nitrogen removal. For this reason, nitrogen storage and ammonia volatilization are ignored in Equation 7-1 and the denitrification rate is assumed to equal 15% of the nitrogen loading rate. Nitrogen losses during preapplication treatment depend on the type of treatment. For conventional primary or secondary treatment, nitrogen loss is negligible. As discussed in Section 4.4.1, the nitrogen loss in a pond can be estimated from Equation 4-1.

Conservative nitrogen uptake values are presented for typical crops in Table 7-6.

TABLE 7-6
NITROGEN UPTAKE RATES FOR SELECTED CROPS^a

Crop	Nitrogen uptake rate, kg/ha·yr
Forage	
Alfalfa	300
Bromegrass	130
Coastal bermudagrass	400
Kentucky bluegrass	200
Quackgrass	240
Reed canarygrass	340
Ryegrass	200
Sweet clover	180
Tall fescue	160
Field	
Barley	70
Corn	180
Cotton	80
Milomaize (sorghum)	90
Potatoes	230
Soybeans	110
Wheat	60

a. Values represent lower end of ranges presented in Table 4-12 and are intended for use in Equation 7-1.

1 kg/ha·d = 0.893 lb/acre·d

The calculated value from Equation 7-1 of $L_w(n)$ is then divided by the number of weeks per year of expected operation and compared with the hydraulic loading rate obtained from Figure 7-2. At this point, the engineer should check with the local agricultural or forestry adviser to verify that the selected crop is tolerant of the lower of the two calculated loading rates. If so, the lower of the two loading rates should be used for design purposes. If the selected crop cannot tolerate the design loading rate, a crop with higher moisture tolerance or nitrogen uptake should be selected.

In small communities, the application schedules presented in Table 7-2 are recommended. Again, if a farmer agrees to take and use the wastewater on his own land, he may continue to use any application schedule that has resulted in a well-managed agricultural system.

7.3.2.2 Rapid Infiltration

Hydraulic loading rates for small RI systems can be estimated using Figure 7-3. The permeability of the most restricting soil layer in the soil profile can be measured using techniques described in Section 3.4. In Figure 7-3, the lower curve should be used when primary or pond effluent is to be applied, and the upper curve can be used when secondary effluent is to be applied.

7.3.2.3 Overland Flow

The hydraulic loading rates for small OF systems are the same as recommended in Chapter 6, Table 6-5. Because of operational considerations, it is recommended that either 8 or 12 h/d application periods be used, whichever is most convenient. Simple automation using time switches and solenoid valves allows flexibility in selecting application periods.

7.3.3 Land Area Requirements

Once the hydraulic loading rate has been determined, the amount of land required for land treatment can be calculated. For systems that operate year-round, the land required is simply the design average wastewater flow divided by the annual hydraulic loading rate. For systems that are not operated year-round, the area required is calculated as follows:

$$A = \frac{Q(365)(100)}{(L_w)(t)(10,000)} \quad \text{(Metric units)} \quad (7-2)$$

$$A = \frac{Q(365)(100)}{(L_w)(t)(7.48)(43,560)} \quad (\text{U.S. customary units})$$

where A = area required, ha (acres)

Q = design average wastewater flow, m³/d
(gal/d)

L_w = hydraulic loading rate, cm/wk (in./wk)
(see Section 7.3.2)

t = number of weeks per year during which
wastewater is applied

For example, if a system is operated 43 weeks out of the year, the acceptable hydraulic loading rate is 5.8 cm/wk (2.3 in./wk), and the design average wastewater flow is 900 m³/d (240,000 gal/d), the area required for land treatment is:

$$\begin{aligned} A &= \frac{(Q)(365)(100)}{(L_w)(t)(10,000)} \\ &= \frac{(900)(365)}{(5.8)(43)(10,000)} \\ &= 13.2 \text{ ha (32.5 acres)} \end{aligned}$$

Additional land is required for preapplication treatment, storage, access roads, and in some cases buffer zones. A preliminary allowance of 15 to 20% of the field area is often made for roads, buffer zones, and small unusable land areas. Land requirements for preapplication treatment and storage are determined in the preliminary design of these components.

7.3.4 Distribution Systems

Detailed information on SR distribution systems is presented in Section 4.7 and Appendix E. Additional considerations for small communities are presented in this section.

Distribution methods are selected on the basis of terrain, type of land treatment system, and local practice. In small communities, it is prudent to choose a distribution method that is used locally or that will result in a system that requires only part-time operational attention. If a locally

used distribution method is selected, any specialized equipment and necessary expertise will be more readily available.

Traveling guns require relatively high amounts of labor and are more adaptable to systems where several, odd-shaped fields are irrigated each season, so they are usually owned and operated by a local farmer. Both solid set and center pivot irrigation systems can be adapted to either municipally owned or farmer owned small irrigation systems. Center pivots will generally not be applicable for very small SR systems (below 16 ha or 40 acres).

Distribution systems for RI and OF facilities are described in Sections 5.6.1 and 6.6, respectively.

7.4 Typical Small Community Systems

To illustrate some of the features of small scale land treatment systems, four cases are described in this section. These include two SR options, one RI, and one OF system. It is not intended that the site specific criteria for these four systems be applied for process design elsewhere. The concepts will be valid, but specific criteria will depend on individual site characteristics.

7.4.1 Slow Rate Forage System

7.4.1.1 Introduction

A pond system using SR application of wastewater onto several grassed plots is often a workable design for a small community that does not generate sufficient wastewater flow to be economically beneficial for irrigating a cash crop.

7.4.1.2 Population

The community, located in eastern Nebraska, has a present population of approximately 300. The design population for the treatment facility is 310.

7.4.1.3 Flow

The flow to the treatment facility is strictly domestic wastewater, because there are no industries in the community. The system is designed to treat an average per capita flow of $0.25 \text{ m}^3/\text{d}$ (65 gal/d), or a total flow of $76 \text{ m}^3/\text{d}$ (20,000 gal/d). Low per capita flows are very common for small communities having no industries and very minimal commercial development. Actual flows to the system have gradually increased as residents switched from their

old septic tank systems to the municipal collection system. Flows are commonly in the 57 to 95 m³/d (15,000 to 25,000 gal/d) range.

7.4.1.4 Climate

The normal annual precipitation is 84 cm/yr (33 in./yr) and the average annual gross lake evaporation is 109 cm/yr (43 in./yr). The mean number of days in which the maximum daily temperature exceeds 32 °C (90 °F) is 40, and the mean number of days in which the minimum daily temperature falls below 0 °C (32 °F) is 130. In an average year, there are 232 days between the last killing frost in the spring and the first frost in the fall.

7.4.1.5 Site Characteristics

The silt loam soils at the proposed treatment site are deep, nearly level, and well drained. Surface soils are silt loam and the subsoils are silty clay loam. Permeability is moderately slow in the 1.0 to 1.5 cm/h (0.4 to 0.6 in./h) range. The site is relatively level and does not overlie a potable aquifer.

7.4.1.6 Treatment Facility Design

The treatment facility consists of a single cell unaerated pond followed by a series of four grassed plots which receive wastewater from the pond. Effluent is not disinfected. The pond provides both wastewater treatment and storage. The degree of treatment in the pond is not a significant factor in design, other than providing at least the necessary primary treatment for removal of heavy solids and rags that could plug distribution piping. The storage volume facilitates operation of the system, since it is not necessary to have an overflow during periods of heavy precipitation or other unfavorable conditions, and the grassed plots can be allowed to dry between applications to allow mowing and maintenance. The design information is summarized in Table 7-7.

The single cell pond is sized similarly to the first cell of a conventional facultative pond system. The design BOD loading is 34 kg/ha:d (31 lb/acre:d), a generally accepted loading rate in Nebraska, and results in minimal septicity or blue-green algae problems. Higher loadings may be allowed by other states where ponds do not become ice covered in the winter. By having a 1.8 m (6 ft) water depth, 1.2 m (4 ft) of storage volume is provided above the 0.6 m (2 ft) water level. The storage volume in the 0.7 ha (1.7 acre) pond is 7,378 m³ (1.95 Mgal) above the 0.6 m

(2 ft) depth. This capacity provides adequate storage during the approximately 133 days (19 weeks) each winter that the plots are not irrigated, based on the design flow and seepage losses of 0.3 cm (0.125 in.) per day.

TABLE 7-7
DESIGN INFORMATION
FOR SR SYSTEM

Design flow, m ³ /d	76
BOD loading, kg/d	24
Design population	310
Treatment pond	
Size, ha	0.7
Depth, m	1.8
Capacity above 0.6 m level, m ³	7,378
Bermed grassed plots	
Number	4
Size (each), ha	0.35

The total size of the grassed plots was determined as follows. Calculated design losses from the pond, including seepage and net evapotranspiration, totaled 142 cm/yr (56 in./yr). Using this value, the design overflow from the pond (Q_o) was calculated:

$$\begin{aligned}
 Q_o &= (76 \text{ m}^3/\text{d} \times 365 \text{ d/yr}) && (7-3) \\
 &- (142 \text{ cm/yr} \times 1 \text{ m}/100 \text{ cm} \times 7,000 \text{ m}^2) \\
 &= 17,800 \text{ m}^3/\text{yr} \text{ (4.7 Mgal/yr)}
 \end{aligned}$$

Using the limiting soil permeability of 1.0 cm/h (0.4 in./h), a hydraulic loading rate of 3.8 cm/wk (1.5 in./wk) was obtained from Figure 7-2. Next, the area required for SR was calculated (Equation 7-4):

$$\begin{aligned}
 A &= [(17,800 \text{ m}^3)/(3.8 \text{ cm/wk} \times 33 \text{ wk})] && (7-4) \\
 &\times (100 \text{ cm/m}) \times (\text{ha}/10,000 \text{ m}^2) \\
 &= 1.4 \text{ ha (3.5 acres)}
 \end{aligned}$$

Four grassed plots, each 0.35 ha (0.88 acre) were designed.

Multiple small plots were selected for several reasons. Each plot is small enough to facilitate uniform flooding.

Also, the use of multiple plots makes it possible for the operator to mow or make repairs on a dry plot while the other plots are being used for wastewater application.

Any one plot does not receive more water than can percolate within 12 hours. This helps prevent damage to the grass cover and also provides some leeway in case precipitation is received after a cell has been flooded. Ignoring evapotranspiration, the limiting soil permeability rate of 1.0 cm/h (0.4 in./h) dictates that not more than 12 cm (4.7 in.) can be applied per each 1 day application period. To obtain an average hydraulic loading rate of 3.8 cm/wk (1.5 in./wk), each application period must be followed by 21 days of drying. In practice, one plot is flooded on each of 4 consecutive days. After an additional 18 days of drying, flooding is resumed. This sequence continues for approximately 232 days. During the winter (approximately 133 days), all wastewater is stored in the pond.

The overflow control structure designed for this system requires minimal operator attention. The structure uses an overflow pipe that can be raised or lowered in increments to release the necessary volume of effluent. A cross-sectional detail of the structure is included in Figure 7-4.

The grassed plots are quite shallow, having only 0.6 m (2 ft) high dikes. The slopes are 4:1, making the basins readily accessible to mowing equipment. This design helped minimize the amount of earthwork necessary during construction and also maximized the amount of usable area since less dike area was required. Local SCS offices and publications were consulted to obtain the necessary information for selecting a seeding mixture, which needed to be suitable for periodic flooding. A mixture of Reed canarygrass, switchgrass, redtop, and intermediate wheatgrass was planted.

Effluent distribution to the grassed plots is by gated pipe along the toe of the inner slope of one side. This allows more uniform flooding of the basin as compared to a single inlet structure. The area under the pipe and in the direction of flow from the pipe has a layer of rock to minimize erosion and channelization of the flow.

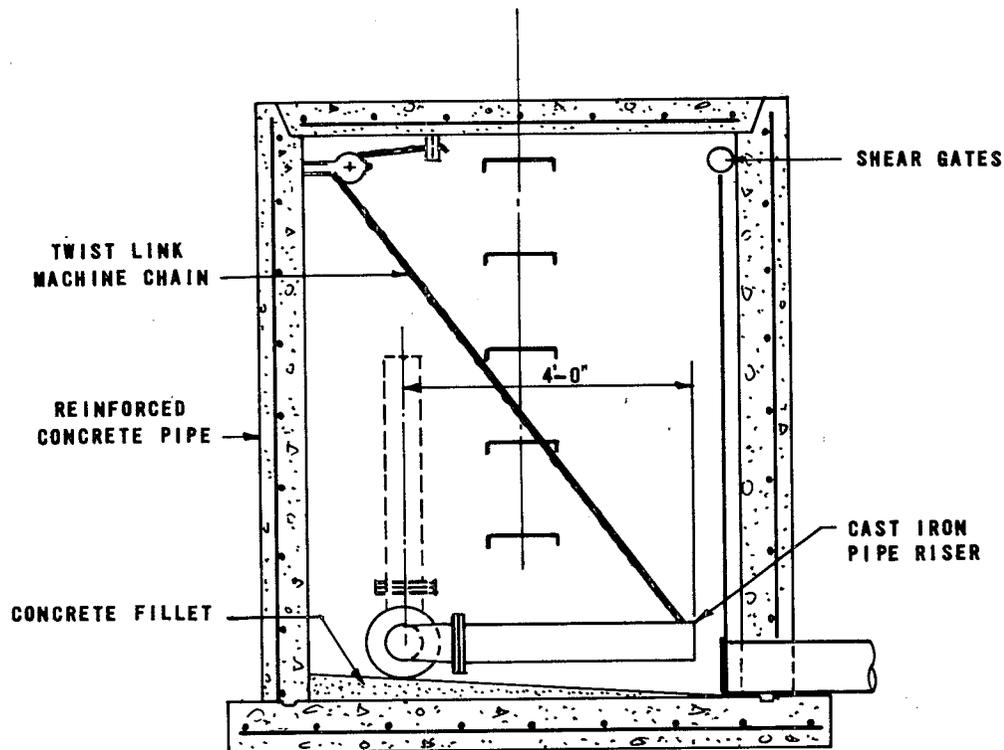

FIGURE 7-4
OVERFLOW CONTROL STRUCTURE FOR
POND DISCHARGE TO SR SYSTEM

7.4.1.7 Performance

When the facility was first started up, flows were quite low until all of the residences were connected. The pond provided complete retention of all flows during the first 2 years of operation, with no overflow to the grassed plots. In the third year, only two application periods were used: one in the spring and one in the fall. The number of applications per year has been gradually increasing as flows have approached the anticipated design loadings. A good stand of grass has been maintained in the application plots. This grass cover enhances infiltration and provides maximum evapotranspiration of the wastewater applied.

7.4.1.8 Staffing

The system requires only one part-time operator. Duties at the pond include mowing, valve operation, weed control, and maintenance of fences, access road, valves, and distribution piping.

7.4.2 Slow Rate Forest System

7.4.2.1 Introduction

This forested SR system is located at Kennett Square in southeastern Pennsylvania. The system, consisting of a series of treatment ponds followed by sprinkler application, has been operated since 1973. The system serves two retirement communities and is operated by the wastewater authority.

7.4.2.2 Population and Flow

The population of the two communities totals 725. The flow, which is entirely domestic wastewater, is currently 189 m³/d (50,000 gal/d). The design flow is 265 m³/d (70,000 gal/d).

7.4.2.3 Climate

Precipitation and evaporation are nearly equal with average annual precipitation at 110 cm (43 in.) and average annual pan evaporation estimated to be 120 cm (47 in.). Average annual temperature is 11.9 °C (53.4 °F).

7.4.2.4 Site Characteristics

The application area is covered with a native stand of beech, maple, poplar, and oak trees. The soils are basically silt loams with predominant slopes between 3 and 8%. Soils are moderately deep and permeable with slightly acidic pH values. The soil permeability of 1.5 to 5 cm/h (0.6 to 2 in./h) would support a loading rate of 5 cm/wk (2 in./wk) or more on a hydraulic loading basis (Figure 7-2).

7.4.2.5 Treatment Facility Design

The layout of treatment facilities is presented in Figure 7-5; photographs of the treatment pond and sprinkler application are shown in Figure 7-6. Wastewater is treated in three treatment ponds, disinfected, and applied via sprinklers onto 3.24 ha (8 acres). The first pond is aerated, covers a surface area of 0.128 ha (0.3 acre), and is 4 m (13 ft) deep. Aeration is provided by a 7.5 kW (10 hp) floating surface aerator. Wastewater then flows by gravity through two nonaerated ponds that are 2.1 m (7 ft) and 2.4 m (8 ft) deep and cover 0.68 ha (1.69 acres) and 0.30 ha (0.75 acre), respectively. Total detention in the three ponds is 80 d at current flows.

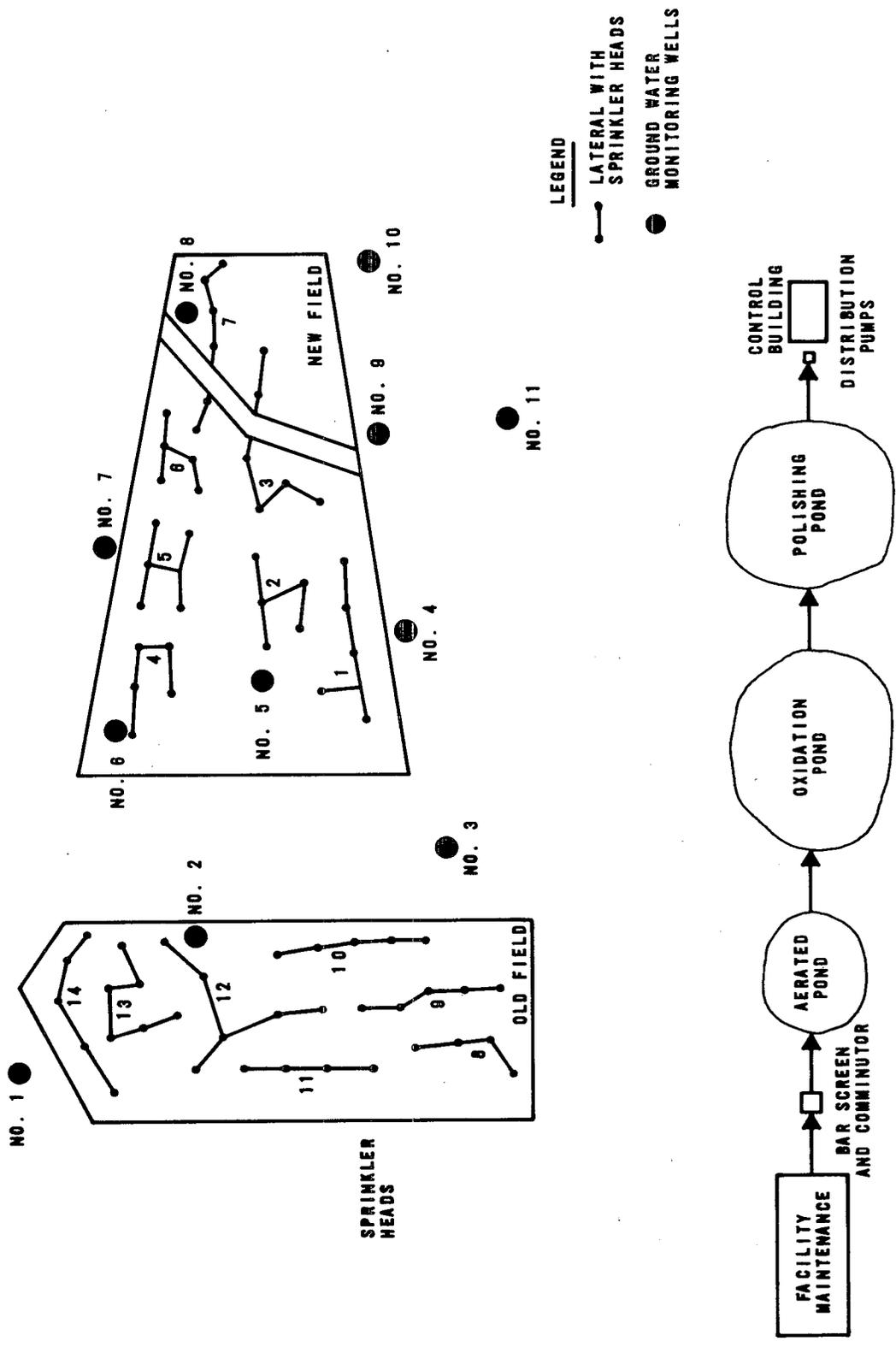
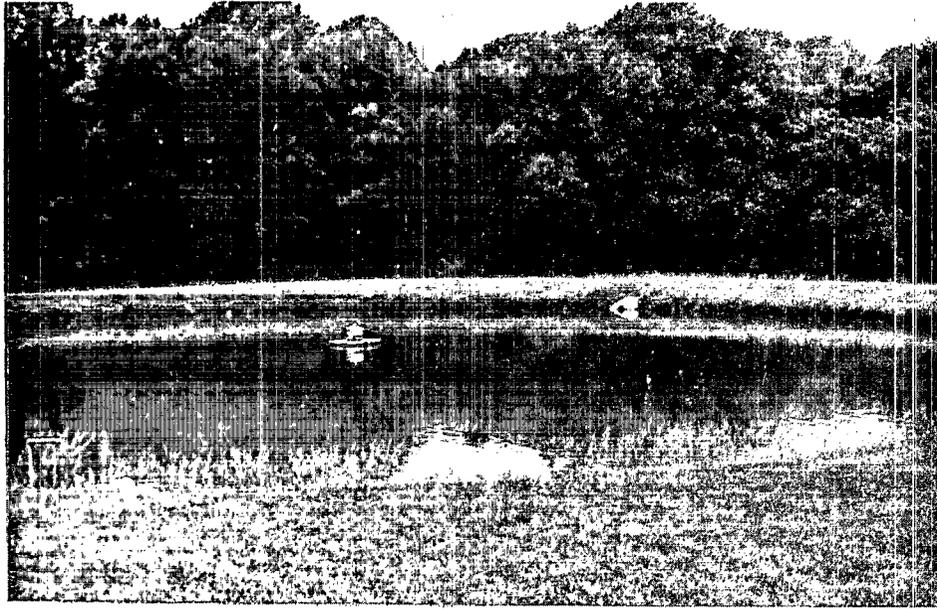
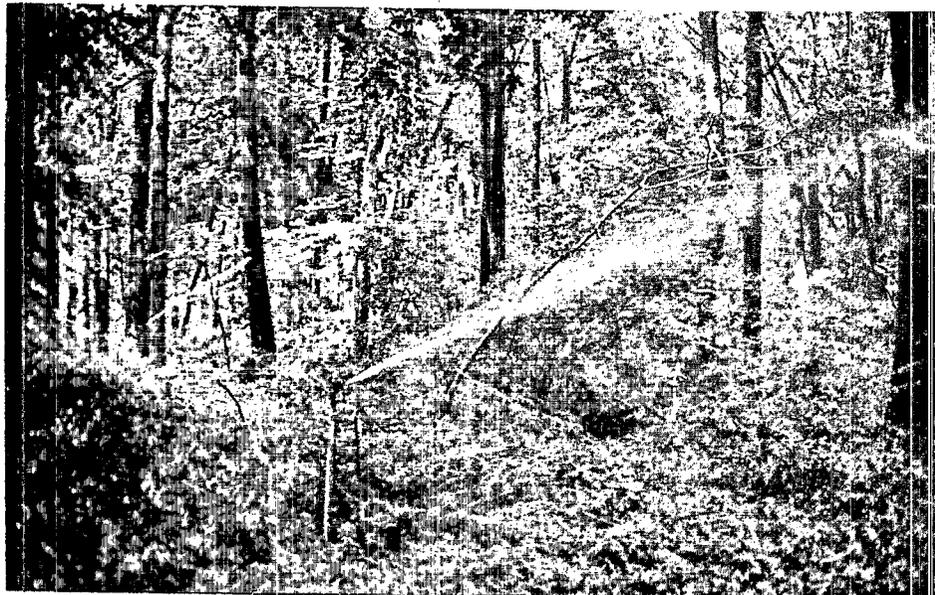

FIGURE 7-5
TREATMENT FACILITY LAYOUT - KENNETT SQUARE, PENNSYLVANIA, SR SYSTEM



TREATMENT POND



SPRINKLER APPLICATION IN EXISTING HARDWOOD FOREST

FIGURE 7-6
SR FACILITIES AT KENNETT SQUARE, PENNSYLVANIA

The design hydraulic loading rate is 5.1 cm/wk (2 in./wk), which is the State of Pennsylvania guideline. The nitrogen loading is 279 kg/ha·yr (248 lb/acre·yr) for the design flow which is somewhat high for application to an existing hardwood forest. Because of the relatively mild climate, year-round application was planned.

The application area is divided into 14 separate areas or plots. Wastewater is applied for 24 hours on 4 to 6 plots each day, 5 days per week. On this schedule, an individual plot receives effluent every fourth day. Storage for weekends and cold weather is possible in the treatment ponds. The main lines and laterals are buried with drain valves to drain the lines after applications are complete.

A buffer zone of approximately 46 to 61 m (150 to 200 ft) is maintained between the application site and the nearest residence. This area is covered with grass and trees. All stormwater runoff from the community is diverted around the site. Stormwater generated onsite is allowed to run off onto adjacent land. Site access is controlled by signs and fencing; however, there are some nature trails in the area to which access is permitted.

7.4.2.6 Operation and Performance

The system has operated satisfactorily for 8 years. During winter operation, sprinkling is practiced until the temperature drops to -6.7 °C (20 °F). Frost heave problems have affected valve boxes placed in the forest. Screening of the applied water is needed to avoid nozzle clogging from debris that falls into the ponds.

Treatment performance of the system can be measured using the ground water monitoring wells. The depth to ground water varies from 3.6 to 9.1 m (12 to 30 ft) in the 11 monitoring wells. The range of nitrate nitrogen concentrations is from 0 to 4.8 mg/L and indicates satisfactory performance, in spite of the relatively high nitrogen loading (Section 7.4.2.5).

7.4.2.7 Staffing and Budget

One operator spends approximately 6 h/d, 5 d/wk operating and maintaining the wastewater treatment system. Of this total, 2 h/d is associated with the SR land treatment system.

A total of \$15,000/yr is budgeted for operation and maintenance of the system. Of this total, 37% or \$4,070/yr is associated with land treatment.

7.4.3 Rapid Infiltration

7.4.3.1 Introduction

An RI system for a small community need not be designed for intensive wastewater applications at maximum RI rates, which could involve the need for recovery of renovated water and a relatively high level of operation and management. Instead, the design can be simplified to meet the objectives of wastewater treatment and still maintain ease of operation. The following example illustrates an adaptation of an RI system that normally operates at very low application rates, but has the capability of treating the exceptionally high flows that occur occasionally.

7.4.3.2 Population

The facility serves the small, rural community of Chapman in east central Nebraska. The community is primarily residential, with a small commercial district, but with no industries. The present population is estimated to be 400.

7.4.3.3 Flow

The treatment pond was designed to serve a population of 500. When the treatment facility was designed, there was no past history of wastewater flows and an average per capita contribution of $0.26 \text{ m}^3/\text{d}$ (70 gal/d), or total flow of $132.5 \text{ m}^3/\text{d}$ (35,000 gal/d), was assumed. Actual dry-weather flows have averaged approximately $66 \text{ m}^3/\text{d}$ (17,400 gal/d). This flow amounts to less than $0.19 \text{ m}^3/\text{capita}\cdot\text{d}$ (50 gal/capita·d), but is typical for this type of small, rural community where average water use is low. The fact that the town does not have a municipal water system is another reason that water use and wastewater flows are very low.

In contrast to the low average dry-weather flows, however, are very high peak flows during periods when parts of the collection system are subject to infiltration from high ground water elevations. Peak flows have ranged to as high as $1,341 \text{ m}^3/\text{d}$ (354,400 gal/d) on a monthly average. The peak flows are sustained, and have in the past stayed high for as long as 6 months at a time. This is a significant factor affecting a treatment facility since the pond system must handle, at times, flows ranging from 2 to 10 times the design average flow.

7.4.3.4 Climate

The normal annual precipitation is 63.5 cm/yr (25 in./yr) and the average annual gross lake evaporation is 114.3 cm/yr

(45 in./yr). There are 45 days per year when maximum daily temperatures exceed 32 °C (90 °F) and 150 days when the minimum temperature is below 0 °C (32 °F). The mean length of the frost-free period in the area is 160 days.

7.4.3.5 Site Characteristics

Soils in the area formed in alluvium on river bottom lands, and the topography is relatively flat. At the pond site, the predominant soil type is a moderately deep, nearly level, somewhat poorly drained loam formed in calcareous loamy alluvium. The depth to the water table ranges from 0.6 to 1.2 m (2 to 4 ft). The loam surface layer and subsoil have moderate permeability of 1.5 to 5.1 cm/h (0.6 to 2.0 in./h). The underlying gravelly sand, which is found 51 to 102 cm (20 to 40 in.) below the ground surface, has very rapid permeability of over 51 cm/h (20 in./h).

7.4.3.6 Treatment Facility Design and Performance

The treatment facility includes a pond and a single RI basin; design criteria for these facilities are summarized in Table 7-8. The pond consists of two cells, one having a surface area of 0.7 ha (1.8 acres) and the other having 0.4 ha (1.0 acre). The maximum water depth of the cells is 1.5 m (5.0 ft). Dikes around the pond have an overall height of 2.4 m (8 ft). The soils at the bottom of the pond were medium and fine sands. Bentonite was added at the rate of 4.5 kg/m² (20 tons/acre) to the bottom of the pond to limit seepage to less than 0.64 cm/d (0.25 in./d).

TABLE 7-8
DESIGN INFORMATION FOR CHAPMAN RI SYSTEM

Design flow, m ³ /d	132.5
BOD loading, kg/d	45
Year built	1965
Design population	500
Pond cell No. 1	
Surface area, ha	0.7
Depth, m	1.5
Capacity above drawoff level, m ³	6,190
Pond cell No. 2	
Surface area, ha	0.4
Depth, m	1.5
Capacity above drawoff level, m ³	3,160
Total detention time above drawoff level at design flow, d	70
Infiltration basin size, ha	0.6
Hydraulic loading rate at design flow, m/yr	5

The design of the pond is such that the two cells can be operated either in series or parallel. The overflow control box can be adjusted so that the water level in either of the cells can be drawn down or set for constant overflow from one or both cells. Water is drawn from the pond cells at the 0.6 m (2 ft) depth.

The normal operating sequence for the system has been series flow through the two cells when the pond is not ice covered, with a constant overflow from the second cell in series to the infiltration basin. During the winter when the pond cells are ice covered, operation is switched to parallel to spread the incoming load over the maximum surface area. This results in a shorter recovery period in the spring when the ice cover melts and the cells go from the anaerobic to the aerobic state. There is normally some overflow to the infiltration basin during the winter. At the design flow, the net yearly overflow to the infiltration basin would be 29,300 m³ (7,444,000 gal).

The two pond cells are followed by a single RI basin. To take advantage of the higher permeability of the underlying soil materials, the top 0.9 m (3 ft) of RI basin soil was stripped during basin construction. However, the design hydraulic loading rate was limited to 5.0 m/yr (16.4 ft/yr) to simplify basin operation. A basin area of 0.6 ha (1.4 acres) was necessary to allow the design loading rate at the design pond overflow rate. Following construction, the basin was seeded with a mixture of Reed canarygrass and bromegrass. A grass cover has been maintained to help preserve the soil's permeability.

Currently, the average influent flow is approximately half the design flow (Table 7-9) and the net overflow to the infiltration basin averages 5,150 m³/yr (1,360,000 gal/yr). The resulting hydraulic loading rate is 0.9 m/yr (2.9 ft/yr). However, during periods of heavy infiltration into the collection system, the average daily flow to the RI basin is 1,375 m³/d (350,000 gal/d). This results in a periodic hydraulic loading rate of 22.6 cm/d (8.9 in./d), or 82.5 m/yr (271 ft/yr) expressed as an annual rate. Although this temporary rate is well below the measured soil permeability of at least 51 cm/h (20 in./h), it exceeds the recommended loading shown in Figure 7-2 somewhat.

TABLE 7-9
WASTEWATER FLOWS TO CHAPMAN RI SYSTEM
m³/d

Year	Avg daily flow	Monthly flows	
		Minimum	Maximum
1974			
Jan-Jun	870.6	292	1,341
Jul-Dec	63.0	55.1	79.0
1976	65.5	58.7	82.1
1977	65.9	60.2	78.3
1979 ^a	86.3	71.9	132.1

a. During the months of May, June, and July, flows were above normal and were in the 122-132 m³/d range. This corresponded to a period of high ground water elevations.

Although the design and actual average hydraulic loading rates are considerably lower than the range of 50 to 60 m/yr (165 to 200 ft/yr) recommended in Figure 7-2, the use of a lower rate was advantageous for several reasons, including:

- A grass cover can be maintained in the bottom of the basin to help preserve soil permeability.
- The treatment facility is able to treat peak wastewater flows that greatly exceed design average flows.

7.4.3.7 Ground Water Quality

Since high ground water levels are typical of the area in which the treatment facility is located, the performance of the facility in terms of possible ground water contamination is an important consideration. The pond has been in operation for 15 years, so there has been adequate time for possible water quality changes caused by pond operation to have been detected. The data indicate that the facility has not caused increased ground water levels of nitrates or chlorides that could be associated with wastewater discharges.

7.4.3.8 Costs and Staffing

The total cost for constructing the collection system and treatment ponds in 1965 was \$110,958. The treatment facility portion of the total amounted to \$40,520.

The entire system has been operated by one part-time operator whose duties include maintenance of three pumping stations in the collection system and operation and maintenance at the pond site. Work at the treatment facilities consists of operating valves, mowing, weed control around the edge of the water in the pond cells and in the RI basin, and maintenance of access road and fences. Since there is no surface discharge of effluent from the facility, laboratory testing of water quality has not been required.

7.4.4 Overland Flow

7.4.4.1 Introduction

A small, full-scale OF system is operating at Carbondale, Illinois, treating pond effluent. The wastewater is domestic in nature and generated at the 54 unit Cedar Lane Trailer Court. The population of 135 has been relatively stable since construction in the 1950s. Wastewater flow is $38 \text{ m}^3/\text{d}$ (10,000 gal/d).

Prior to 1976, wastewater was treated using a septic tank followed by a 0.28 ha (0.7 acre) stabilization pond and surface water discharge. Effluent from the pond did not meet Illinois intermittent stream requirements, which include a 1.5 mg/L ammonia nitrogen limit on the discharge. An upgrading of the treatment, therefore, was required.

7.4.4.2 Site Characteristics

The terrain is rolling and the grass covered site, which is near the pond, has slopes ranging from 7 to 12%. The soil is fine granular glaciated material with low permeability. A section of the slope 10 m (30 ft) wide and 60 m (200 ft) long (downslope) was used.

7.4.4.3 Treatment Facility Design

The hydraulic loading rate is 44 cm/wk (17.3 in./wk), which is higher than recommended in Figure 7-2. The first 30 m (100 ft) of slope is at 7% grade and the last 30 m is at 12%. The pond effluent is pumped to the top of the slope and applied uniformly across the top of the slope via a 10 cm (4 in.) perforated pipe. The predominant grass on the slope is tall fescue. The system was constructed by Southern Illinois University and used for several years as a research facility. No storage is provided other than the existing stabilization pond [3].

7.4.4.4 Operation

During 1976 and 1977, application rates varied from 0.29 to 0.57 m³/m·h (24 to 42 gal/ft·h). The application period varied from 4 to 24 h/d. A typical application period was 9 h/d. Runoff from the slopes accounted for over 80% of the applied wastewater. Erosion was not a problem.

7.4.4.5 Performance

The treatment performance of the OF system was monitored relatively intensely in the fall of 1976. The results are presented in Table 7-10.

TABLE 7-10
TREATMENT PERFORMANCE OF CARBONDALE OF SYSTEM [4]
mg/L except as noted

Constituent	Applied wastewater	Treated runoff
BOD	30-110	4-7
SS	20-60	4-7
Phosphorus, total	3-4	0.2-0.5
Ammonia nitrogen	20-40	0.1-1.5
Fecal coliforms, colonies/100 mL	35,000	600-2,500

In 1977 when application rates and daily application periods were increased, the treatment performance declined. For example, when application times of 24 h/d were used, removal of ammonia dropped off significantly. The runoff after 60 m (200 ft), however, contained less than 1 mg/L ammonia when application periods were 12 h/d or less.

7.5 References

1. Environmental Protection Agency. Process Design Manual for Wastewater Treatment Ponds. (In Preparation).
2. Metcalf & Eddy, Inc. Wastewater Engineering: Treatment, Disposal, Reuse. McGraw Hill Book Company. New York, N.Y. 1979.
3. Hinrichs, D.J. et al. Assessment of Current Information on Overland Flow Treatment of Municipal Wastewater. Environmental Protection Agency, Office of Water Programs. EPA 430/9-80-002. MCD-66. May 1980.

4. Muchmore, C.B. Overland Flow as a Tertiary Treatment Procedure Applied to a Secondary Effluent. Presented at Illinois Workshop on Land Application of Sewage Sludge and Wastewater. Champaign, Illinois. October 18-20, 1976.

CHAPTER 8

ENERGY REQUIREMENTS AND CONSERVATION

8.1 Introduction

Land treatment systems energy needs consist of preapplication treatment, transmission to the application site, distribution pumping (if necessary), and tailwater recovery or pumped drainage (if required). The energy required for preapplication treatment varies considerably depending on the degree of treatment planned. The degree of treatment depends on type of system, local conditions, and regulatory requirements. Determining energy requirements for all preapplication treatment systems is beyond the scope of this manual; however, equations for estimating energy consumption of minimum preapplication unit processes are presented in Section 8.6. Energy required for construction is too site-specific to be included in this manual.

Energy for transmission from the preapplication treatment site to the land treatment site depends on topography and distance. This is especially important when considering alternative sites. The energy required for transmission pumping can range anywhere from zero to nearly 100% of the energy requirements for a land treatment system. This may often justify a higher priced parcel of land closer to the application site. Transmission pumping is sometimes designed to also provide pressure for sprinkler application. For sites located below preapplication treatment facilities with surface application systems, pumping usually will not be required.

Slow rate systems vary in terms of distribution energy and possible tailwater control. Distribution systems may be surface or sprinkler. Tailwater control requirements depend on the type of distribution system and discharge standards. Sprinkler systems can be controlled so that no tailwater is produced. Surface systems will usually have tailwater that must be contained and reapplied.

Rapid infiltration systems are usually designed for surface distribution and application and so require minimal energy. There is no tailwater pumping, but pumped drainage may be necessary to control ground water levels or recover treated percolate.

Overland flow systems can use surface distribution with low head requirements (Section 6.6.1). Sprinkler systems can also be used so energy will be required for

pressurization. There is no significant subsurface drainage with OF so this potential energy requirement is avoided.

8.2 Transmission Pumping

Under conditions with favorable topography, a gravity transmission system may be possible and pumping not required. If pumping is required, the energy needs vary substantially depending on the required head and how the transmission system is designed. The effect of topography on pumping costs and energy use should be thoroughly evaluated during the planning process.

Energy efficient design involves coordination of all elements of the system including sizing of pumps, pipelines, and storage facilities, as well as system operating strategy. The system operating strategy involves placement and sizing of storage facilities. Wet wells are typically not designed for significant flow equalization. Transmission pumping systems are sized to handle the peak community flows. This can be accomplished by multiple pumps, one pump with a variable speed drive, or some combination. Each system has differing constraints that alter decisions on its design. Ideally, all flow is equalized to provide nearly constant flow pumping. This allows selection of a pump at a maximum efficiency.

Variable speed drives, which are not as efficient as constant speed drives, would not be required. Unfortunately, flow equalization is not always feasible. In some instances, equalization costs may not be recovered by energy savings. The choice of pumping and equalization system design is site-specific. Regardless of the pumping system used, pipeline size can be optimized. Optimization of pipeline size will provide the optimum transmission system.

The following pipe size optimization procedure was taken from reference [1]. Obviously, larger pipe sizes result in lower pumping energy; however, excessively large pipes are not economical.

$$D_{\text{opt}} = A Q^{0.486} C^{-0.316} (KT/PE)^{0.17} \quad (8-1)$$

where D_{opt} = optimum pipeline diameter, m (ft)

A = constant, 3.53 (2.92)

Q = average flow, m^3/s (ft^3/s)

C = Hazen-Williams coefficient

- K = average price of electricity, \$/kWh
- T = design life, yr
- P = unit cost of pipe, \$/linear m·mm dia.
(\$/linear ft·in. dia.)
- E = overall pumping system efficiency,
decimal

For example, at a flow of 0.219 m³/s (7.7 ft³/s), a Hazen-Williams coefficient of 100, a pipeline cost of \$0.26/linear m·mm diameter, an overall pumping system efficiency of 75%, electricity at \$0.045/kWh, and a design life of 20 years, the optimum pipe diameter is 0.50 m (20 in.) [2].

With the line size determined and a pumping system selected, the actual energy requirement can be determined by the following equation.

$$\text{Energy, kWh/yr} = \frac{(Q)(TDH)(t)}{(F)(E)} \quad (8-2)$$

where Q = flow, L/min (gal/min)

TDH = total dynamic head, m (ft)

t = pumping time, h/yr

F = constant, 6,123 (3,960)

E = overall pumping system efficiency, decimal

The overall efficiency varies not only with design specifics but also with the quality of liquid being pumped. Raw wastewater pumping requires pumps that pass larger solids than treated effluent. These pumps are less efficient. When a specific design is being contemplated, the overall efficiency should be determined using pump, motor, and driver efficiencies determined for the equipment to be used. For initial planning or preliminary work such as site selection, overall system efficiencies can be assumed as follows.

Raw wastewater	40%
Primary effluent	65%
Secondary or better effluent, tailwater, recovered ground water, or stormwater	75%

8.3 General Process Energy Requirements

8.3.1 Slow Rate

Energy consumption for SR consists of transmission, distribution, possible tailwater reapplication, and crop management. A wide range of surface and sprinkler distribution techniques is possible. Surface systems require energy for distribution and tailwater reapplication to the site. Sprinkler systems are highly variable with possible pressure requirements ranging from 10 to 70 m (30 to 230 ft). Generally, pressures will be in the 15 to 30 m (50 to 100 ft) range.

Crop production energy varies substantially between the type of crops grown. Table 8-1 shows energy requirements for corn and forage crops.

TABLE 8-1
ENERGY REQUIREMENTS FOR
CROP PRODUCTION [3]

Operation	Requirement, MJ/ha	
	Corn	Alfalfa
Tillage and seeding	1.41	0.22
Cultivation	0.37	NA
Herbicide/insecticide	0.37	0.37
Harvest	0.37	1.51 ^a
Drying	4.69 ^b	NA ^c
Transportation	<u>1.04</u>	<u>1.53</u>
Total	8.25	3.63

a. Hay.

b. Mechanically dried; may in some cases be field dried.

c. Not applicable, field dried.

8.3.2 Rapid Infiltration

Rapid infiltration system energy requirements are primarily those needed for transmission. Surface distribution is normally used. There are no crops grown so no fuel is consumed for that purpose. Occasionally, there are situations where recovery wells and pumps are used. Fuel will be needed for basin scarification, but the quantity is not significant because the operation is infrequent.

8.3.3 Overland Flow

Overland flow treatment can use either surface distribution or sprinkler distribution. Surface distribution requires minimal energy (see Section 8.6), while sprinkler distribution requires pressurization energy.

To prevent nozzle clogging, raw wastewater or primary effluent should be screened prior to distribution. Mechanically cleaned screens are preferred over comminution since shredded material returned to the stream can still cause clogging. The amount of energy required for screening is insignificant compared to the pumping energy required. Equation 8-2 applies for the pumping energy computation.

Overland flow systems require a cover crop that is often harvested and removed from the site. Energy is required in the form of diesel fuel for operating harvesting equipment. Fuel required is the same as presented in Table 8-1 for alfalfa harvest.

A summary of energy requirements for land treatment processes is shown on Table 8-2. The values presented are typical of actual practice.

TABLE 8-2
MOST COMMON UNIT ENERGY REQUIREMENTS FOR LAND
TREATMENT OF MUNICIPAL WASTEWATER

Treatment system	Component	Electricity, kWh/1,000 m ³	Fuel, MJ/1,000 m ³	Total equivalent, kWh/1,000 m ³
Slow rate	Pumping for distribution	0.14	--	0.14
	Crop planting, cultivation, harvest, drying, transport	--	0.68	0.20
	Energy credit for fertilizer value of wastewater	--	(0.50)	(0.14)
Total		0.14	0.18	0.20
Rapid infiltration	Distribution (gravity)	--	--	--
	Recovery wells	0.05	--	0.05
Total		0.05	--	0.05
Overland flow	Transmission	0.10	--	0.10
	Forage harvest	--	0.22	0.06
Total		0.10	0.22	0.06

Note: See Appendix G for metric conversions; kWh are used for electricity and total equivalent energy, MJ used for fuel.

8.4 Energy Conservation

8.4.1 Areas of Potential Energy Savings

With respect to energy conservation, there are two main areas to review. First is transmission to the site. Location of the facility should, if possible, provide for adequate drop in elevation between the preapplication treatment and the land treatment sites. This layout is sometimes possible with RI systems and certain SR systems. It is more difficult to design OF systems in this manner since sloping land is necessary as part of the process. For OF systems, site grading is usually required to obtain desired slope so distribution pumping is typically necessary.

The second area of potential energy savings is with the distribution method. For domestic wastewater with minimal preapplication treatment, surface systems are preferred, since surface systems are not as subject to clogging and usually require less energy.

Distribution for SR systems is a function of topography and the crop. Surface systems can be used on level or graded sites (see Section 4.7.1). In the past, surface systems were preferred by the agricultural industry; however, due to increased labor costs and poor irrigation efficiencies, some existing surface systems have been converted to sprinkler irrigation. For municipal authorities where labor wages are higher than farm worker wages, the increased labor costs are important.

Sprinkler distribution systems are relatively high-pressure devices. Recent advances have been made in sprinkler nozzle design to lower headloss without sacrificing uniformity of application. Figure 8-1 illustrates a center pivot system with two types of sprinklers. The impact sprinklers have a typical pressure loss of approximately 60 to 65 m (200 to 215 ft); whereas, drop nozzles have a headloss of 15 to 20 m (50 to 65 ft). This difference represents an energy savings of about 95 kWh/1000 m³, without sacrificing distribution efficiency.

Surface systems may not require pumping energy except for tailwater recycling. In this case, automated surface systems (Figure 8-2) can be introduced to minimize tailwater recycling requirements.

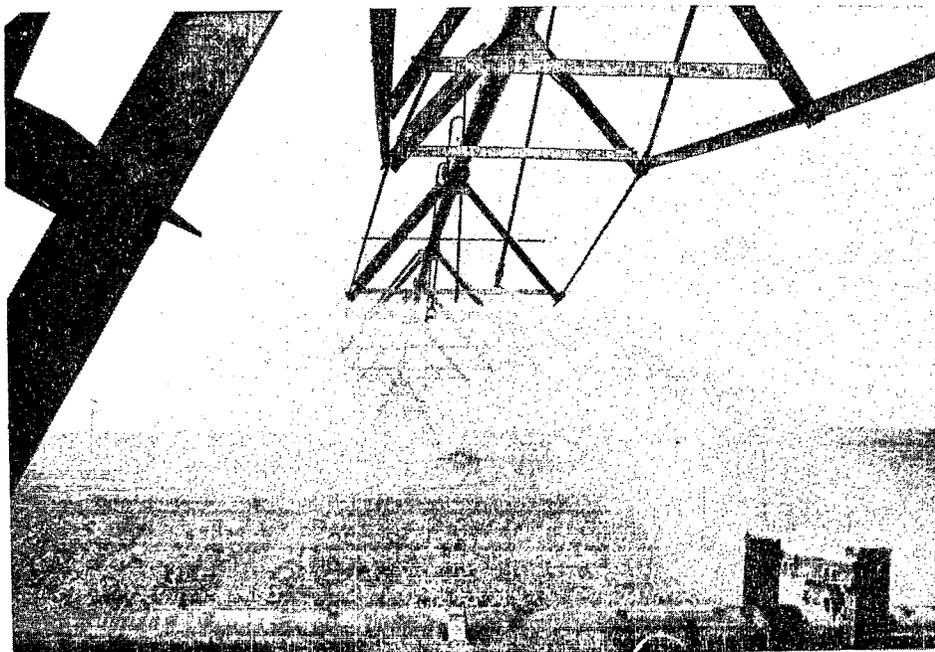

DROP NOZZLE SYSTEM

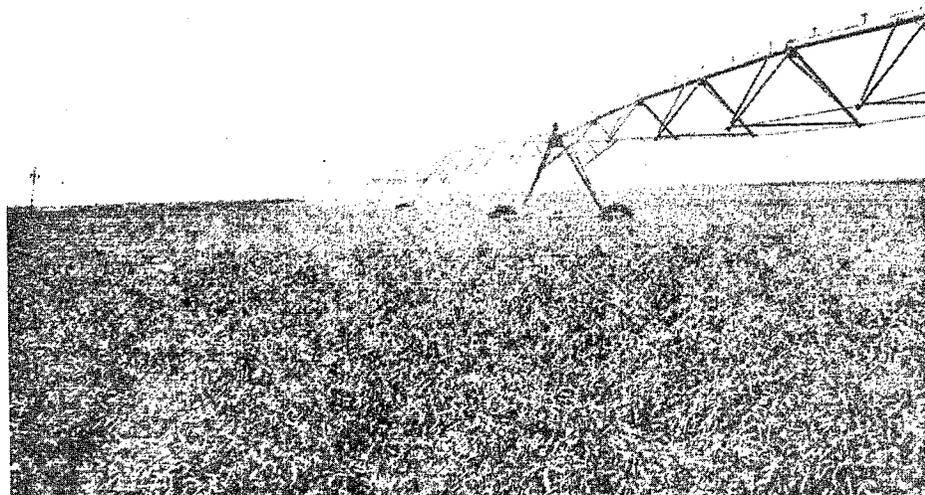

IMPACT SPRINKLER SYSTEM

FIGURE 8-1
CENTER PIVOT SYSTEM

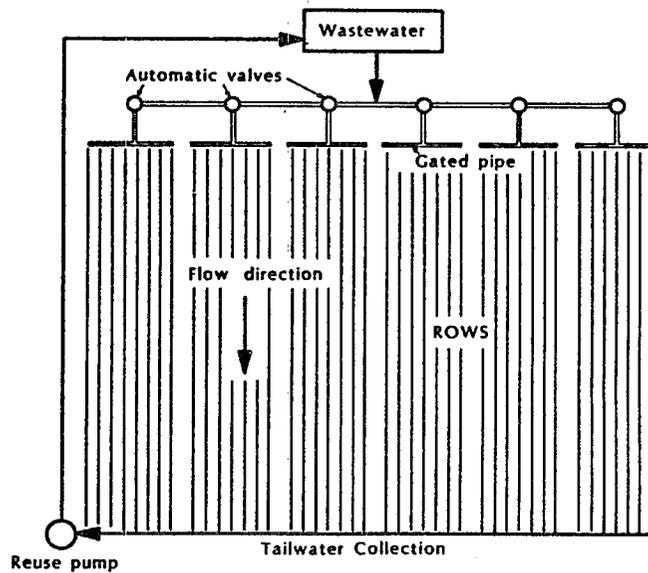

FIGURE 8-2
 AUTOMATIC SURFACE IRRIGATION SYSTEM [4]

8.4.2 Example: Energy Savings in Slow Rate Design

The following example illustrates how effective planning and design can result in energy conservation. A summary of assumed system characteristics used for this example is presented in Table 8-3.

TABLE 8-3
 EXAMPLE SYSTEM CHARACTERISTICS

Average flow, m ³ /d	38,000
System	Slow rate
Preapplication treatment	Pond
Application season	May to October (5 months)
Hydraulic loading, m/yr	1.2
Net land area, ha	1,130
Crop	Corn
Topography	Nearly level, suitable for all types of irrigation
Tailwater control	No surface discharge of applied wastewater allowed

Three systems will be considered: surface distribution by ridge and furrow, and two examples of center-pivot application. Since transmission of wastewater is essentially the same with all alternatives, it will not be included in this discussion.

Ridge and furrow distribution does not require pumping for distribution; but due to a no discharge of tailwater requirement, energy is required to return tailwater back to the application point (assumed head: 3 meters). Depending on the system design, the maximum tailwater recycle will range from 30 to 70% of that applied. Conventional ridge and furrow designs result in lower efficiency, with the higher recycle pumping requirement. Alternatively, ridge and furrow systems with automated recycle cutback or automated valves can improve efficiency by lowering pumping requirements. The potential savings from system automation is summarized in Table 8-4.

TABLE 8-4.
COMPARISON OF CONVENTIONAL AND AUTOMATED RIDGE
AND FURROW SYSTEMS FOR 38,000 m³/d^a

System	Tail-water pumping, kWh/yr	Electricity, \$/yr	Labor, h/yr	Labor cost, \$/yr	Capital cost, \$	Amortized capital, \$/yr	Total annual cost, \$/yr
Conventional	89,300	2,950	2,800	30,800	16,000	1,520	35,270
Automated	<u>33,500</u>	<u>1,100</u>	<u>1,400</u>	<u>15,400</u>	<u>45,000</u>	<u>4,300</u>	<u>20,800</u>
Difference	55,800	1,850	1,400	15,400	-29,000	-2,780	14,470

a. Electricity at \$0.036/kWh. Labor at 1.2 h/ha·d for automated systems; 2.5 h/ha/d for conventional systems. Labor cost at \$11.00/h. Capital costs for pipeline, distribution system, reuse system meters (January 1980). Capital amortized at 7-1/8% for 20 years.

The potential savings using automated irrigation systems are significant; both energy consumption and cost can be reduced substantially. In this example, energy requirements were reduced by about two-thirds, at an overall cost savings of over 50%.

If a center pivot irrigation system is used, tailwater recovery is not needed. However, pumping energy is required to provide nozzle pressure. In this case the main factor in energy conservation is nozzle design. The general goal is to achieve uniform distribution at the lowest possible pressure loss. A conventional center pivot rig employs impact sprinklers on top of the pivot pipeline. These devices require a pumping pressure of approximately 65 m (21 ft). Alternatively, drop nozzles are used in modern

rigs which develop a headloss of about 15 m (150 ft). Drop nozzles have an additional advantage of producing less aerosol than impact systems. Capital costs, and operation and maintenance requirements (except for electricity) are comparable between these two systems. The impact on energy savings is shown on Table 8-5. In this instance, costs were reduced and aerosols were decreased by designing to conserve energy.

TABLE 8-5
 COMPARISON OF IMPACT AND DROP-TYPE
 CENTER PIVOT SYSTEM NOZZLE DESIGNS
 ON ENERGY REQUIREMENTS,
 38,000 m³/day

Nozzle type	Electricity, kWh/yr	Energy cost, \$/yr
Impact	2,230,000	73,600
Drop	<u>1,030,000</u>	<u>34,000</u>
Difference	1,200,000	39,600

8.4.3 Summary

For purposes of comparison the total energy (electricity plus fuel) for typical 3,785 m³/d (1 Mgal/d) systems is listed in Table 8-6 in order of increasing energy requirements. It is quite apparent from Table 8-6 that increasing energy expenditures do not necessarily produce increasing water quality benefits. The four systems at the top of the list, requiring the least energy, produce effluents comparable to the bottom four that require the most.

8.5 Procedures for Energy Evaluations

The following section provides step-by-step procedures for computing energy use for each of the three land treatment systems. Examples are also provided. The energy computation requires site selection and a decision concerning location of preapplication and storage facilities because elevation differences for pumping are critical. The distribution method must also be determined.

TABLE 8-6
TOTAL ANNUAL ENERGY FOR TYPICAL 3,785 m³/d
(1 Mgal/d) SYSTEM (ELECTRICAL PLUS FUEL,
EXPRESSED AS 1,000 kWh/yr) [5]

Treatment system	Effluent quality, mg/L				Energy, 1,000 kWh/yr
	BOD	SS	P	N	
Rapid infiltration (facultative pond)	5	1	2	10	150
Slow rate, ridge + furrow (facultative pond)	1	1	0.1	3	181
Overland flow (facultative pond)	5	5	5	3	226
Facultative pond + intermittent filter	15	15	--	10	241
Facultative pond + microscreens	30	30	--	15	281
Aerated pond + intermittent filter	15	15	--	20	506
Extended aeration + sludge drying	20	20	--	--	683
Extended aeration + intermittent filter	15	15	--	--	708
Trickling filter + anaerobic digestion	30	30	--	--	783
RBC + anaerobic digestion	30	30	--	--	794
Trickling filter + gravity filtration	20	10	--	--	805
Trickling filter + N removal + filter	20	10	--	5	838
Activated sludge + anaerobic digestion	20	20	--	--	889
Activated sludge + anaerobic digestion + filter	15	10	--	--	911
Activated sludge + nitrification + filter	15	10	--	--	1,051
Activated sludge + sludge incineration	20	20	--	--	1,440
Activated sludge + AWT	<10	5	<1	<1	3,809
Physical chemical advanced secondary	10	10	1	--	4,464

NOTE: RBC = rotating biological contactor.

8.5.1 Slow Rate

Step 1: Transmission Pumping

1. Elevation at site _____ m
2. Elevation at source _____ m
3. Elevation difference _____ m
4. Average annual flowrate _____ L/min
5. Pumping system efficiency _____ %
6. Pipeline diameter _____ cm
7. Pipeline length _____ m
8. Pipeline headloss _____ m
9. Total dynamic head _____ m
10. Energy requirement _____ kWh/yr (Eq. 8-2)

Step 2: Distribution Energy

1. Flowrate _____ L/min
2. Pressure head required _____ m
3. System efficiency _____ %
4. Operating time _____ h/yr
5. Pipeline headloss _____ m
6. Total dynamic head _____ m
7. Energy requirement _____ kWh/yr (Eq. 8-2)

Step 3: Tailwater Pumping (if required)

1. Flowrate _____ L/min
2. Lift required _____ m
3. Headloss _____ m
4. Assumed pumping system efficiency _____ %
5. Operating time _____ h/yr
6. Energy requirement _____ kWh/yr (Eq. 8-2)

Step 4: Crop Production (Table 8-1)

1. Tillage and seeding _____ MJ/ha·yr
2. Cultivation _____ MJ/ha·yr
3. Insecticides and herbicides _____ MJ/ha·yr
4. Harvest _____ MJ/ha·yr
5. Drying _____ MJ/ha·yr
6. Transportation _____ MJ/ha·yr
7. Crop area _____ ha
8. Total fuel requirement _____ MJ/yr

Step 5: Combine Steps 1 through 4, expressed as kWh/yr

8.5.2 Rapid Infiltration

Step 1: Transmission Pumping

1. Elevation at site _____ m
2. Elevation at source _____ m
3. Elevation difference _____ m
4. Average flow _____ L/min
5. Assumed pumping system efficiency _____ %
6. Pipeline diameter _____ cm
7. Pipeline length _____ m
8. Pipeline headloss _____ m
9. Total dynamic head _____ m
10. Energy requirement _____ kWh/yr (Eq. 8-2)

Step 2: Drainage Water Control (if necessary)

1. Elevation of water source _____ m
2. Elevation of discharge _____ m
3. Difference in elevations _____ m
4. Pumping system efficiency _____ %
5. Operating hours _____ h/yr
6. Pumped flow _____ L/min
7. Energy requirement _____ kWh/yr (Eq. 8-2)

Step 3: Combine Steps 1 and 2

8.5.3 Overland Flow

Step 1: Transmission Pumping

1. Elevation at site _____ m
2. Elevation at source _____ m
3. Elevation difference _____ m
4. Average annual flow _____ L/min
5. Assumed pumping system efficiency _____ %
6. Pipeline diameter _____ cm
7. Pipeline length _____ m
8. Pipeline headloss _____ m
9. Total dynamic head _____ m
10. Energy requirement _____ kWh/yr (Eq. 8-2)

Step 2: Distribution System

1. Type of system
2. Flowrate _____ L/min
3. Pressure head required _____ m
4. Assumed pumping efficiency _____ %
5. Operating time _____ h/yr
6. Total dynamic head _____ m
7. Energy requirement _____ kWh/yr (Eq. 8-2)

Step 3: Grass Removal (Table 8-1)

1. Maintenance requirements, fuel use _____ MJ/harvest
2. Grass removal frequency _____ harvest/yr
3. Fuel for harvest _____ MJ/ha
4. Total fuel required _____ MJ/year

Step 4: Combine Steps 1 through 3, express as kWh/yr

8.5.4 Examples

Using the previously presented step-by-step procedures, the following example problems were developed.

8.5.4.1 Slow Rate

The slow rate system is designed to treat pond effluent as follows:

Average flow	15,000 L/min
Season	5 months
Applied flow	36,000 L/min
Crop grown	Corn
Distance to site	100 m
Tailwater pumping	Not required
Area	650 ha

Step 1: Transmission Pumping

1. Elevation at site 50 m
2. Elevation at source 48 m
3. Elevation difference 2 m
4. Average annual flowrate 15,000 L/min
5. Pumping system efficiency 40%
6. Pipeline diameter 76 cm
7. Pipeline length 100 m
8. Pipeline headloss 3.4 m
9. Total dynamic head 5.4 m
10. Energy requirement 289,711 kWh/yr

Step 2: Distribution Energy

1. Flowrate 36,000 L/min
2. Pressure required 10 m
3. System efficiency 75%
4. Operating time 3,600 h/yr
5. Pipeline headloss 2 m
6. Total dynamic head 12 m
7. Energy requirement 338,658 kWh/yr

Step 3: Tailwater Pumping (if required) (not required with sprinklers)

1. Flowrate _____ L/min
2. Lift required _____ m
3. Assumed pumping efficiency _____ %
4. Operating time _____ h/yr
5. Energy requirement _____ kWh/yr

Step 4: Crop Production (full)

1. Tillage and seeding 1.41 MJ/ha·yr
2. Cultivation 0.37 MJ/ha·yr
3. Insecticides and herbicides 0.37 MJ/ha·yr
4. Harvest 0.37 MJ/ha·yr
5. Drying 4.69 MJ/ha·yr
6. Transportation 1.04 MJ/ha·yr
7. Crop area 650 ha
8. Total fuel requirement 5,120 MJ/yr = 1,422 kWh/yr

Step 5: Total energy use = 629,791 kWh/yr

8.5.4.2 Rapid Infiltration

The rapid infiltration system is designed to treat primary effluent as follows:

Flowrate	15,000 L/min
Distance to site	5,000 m
Drainage	pumped wells

Step 1: Transmission Pumping

1. Elevation at site 1,115 m
2. Elevation at source 1,105 m
3. Elevation difference 10 m
4. Average flow 15,000 L/min
5. Assumed pumping system efficiency 65%
6. Pipeline diameter 50 cm
7. Pipeline length 5,000 m
8. Pipeline headloss 20 m
9. Total dynamic head 30 m, operating 8,760 h/yr
10. Energy requirement 990,465 kWh/yr

Step 2: Drainage Water Control (if necessary)

1. Elevation of water source 1,105 m
2. Elevation of discharge 1,115 m
3. Difference in elevations 10 m
4. Pumping system efficiency 75%
5. Operating hours 2,920 h/yr
6. Pumped flow 10,000 L/min
7. Energy requirement 63,585 kWh/yr

Step 3: Total energy use = 1,054,050 kWh/yr

8.5.4.3 Overland Flow

An overland flow system is planned for a small community. The system will be used to treat screened raw wastewater. Design parameters are as follows:

Design flow	137 m ³ /d
Distribution method	Gated pipe
Distance from source to site	100 m
Hydraulic loading	4.5 m/yr
Land area	1 ha

Step 1: Transmission Pumping

1. Elevation at site 125 m
2. Elevation at source of 120 m
3. Elevation difference 5 m
4. Average annual flow 95 L/min
5. Assumed pumping system efficiency 40%
6. Pipeline diameter 10 cm
7. Pipeline length 100 m
8. Pipeline headloss 1.22 m
9. Total dynamic head 6.22 m
10. Energy requirement 2,113 kWh/yr

Step 2: Distribution System

1. Type of system - gated pipe
2. Flowrate 95 L/min
3. Pressure head required 3 m
4. Assumed pumping efficiency 40%
5. Operating time 8,760 h/yr
6. Total dynamic head 3.3 m
7. Energy required 1,121 kWh/yr

Step 3: Grass Removal

1. Maintenance requirements, fuel use 0.59 MJ/harvest
2. Grass removal frequency 3 harvest/yr
3. Fuel for harvest (including transportation)
3.04 MJ/ha
4. Total fuel required 3.63 MJ/yr = 1.0 kWh

Step 4: Total energy use = 3,235 kWh/yr

8.6 Equations for Energy Requirements

In addition to Equation 8-1, a large number of equations have been developed from the curves in reference [6] and are presented in reference [5]. Selected equations are presented in this section to allow the engineer to estimate

energy requirements for minimum preapplication treatment and for the three land treatment processes. In all equations, Y is the energy requirement in kWh/yr.

8.6.1 Preapplication Treatment

Mechanically Cleaned Screens

$$\begin{aligned} \log Y &= 3.0803 + 0.1838(\log X) & (8-3) \\ &- 0.0467 (\log X)^2 \\ &+ 0.0428 (\log X)^3 \end{aligned}$$

where Y = electrical energy required, kWh/yr

X = flow, m³/d (Mgal/d)

Assumptions = normal run times are 10 min/h,
bar spacing 1.9 cm (0.75 in.),
worm gear drive is 50% efficient

Comminutors

$$\begin{aligned} \log Y &= 3.6704 + 0.3493(\log X) & (8-4) \\ &+ 0.0437(\log X)^2 \\ &+ 0.0267 (\log X)^3 \end{aligned}$$

Grit Removal

$$\begin{aligned} Y &= AX^{0.24} & (8-5) \\ A &= 73.3 (530) \\ X &= \text{flow, m}^3/\text{d (Mgal/d)} \end{aligned}$$

Assumptions = nonaerated, square tank, 2 h/d operation

Aerated Ponds

$$\begin{aligned} Y &= AX^{1.00} & (8-6) \\ A &= 68.7 (260,000) \\ X &= \text{flow, m}^3/\text{d (Mgal/d)} \end{aligned}$$

Assumptions = low speed mechanical aerators, 30 d detention,
1.1 kg O₂/kWh

Other preapplication treatment processes will involve many potential sludge treatment and disposal options and are included in reference [5].

8.6.2 Land Treatment Processes

For sprinkler application in each land treatment process and OF and RI distribution, use the previous checklist and Equation 8-2. Equations are presented for ridge and furrow, and graded border SR application along with the assumptions.

Ridge and Furrow

Application = 250 d/yr, tailwater return at 25% annual leveling and ridge and furrow replacement

$$Y = AX^{1.00} - \text{electrical} \quad (8-7)$$

A = 3.17 (12,000)
X = flow, m³/d (Mgal/d)

$$Y = AX^{1.00} - \text{fuel} \quad (8-8)$$

Y = MJ/yr (10⁶ Btu/yr)
A = 1.55 (20)
X = flow, m³/d (Mgal/d)

Graded border

Application = 250 d/yr, tailwater return at 25%

$$Y = AX^{1.00} \quad (8-9)$$

A = 4.2 (16,000)
X = flow, m³/d (Mgal/d)

8.7 References

1. Culp/Wesner/Culp. Energy Considerations in Wastewater Treatment. CWC, Cameron Park, California. September, 1980.
2. Patton, J.L., and M.B. Horsley. Curbing the Distribution Energy Appetite. AWWA Journal, 72, No. 6. June 1980.
3. Stout, B.A. Energy Use in Agriculture. Council for Agricultural Science and Technology. Ames, Iowa. Report Number 68. August 1977.
4. Eisenhauer, D.E. and P.E. Fischbach. Automation of Surface Irrigation. Proceedings of the Irrigation Association Annual Conference. February 1978.
5. Middlebrooks, E.J. and C.J. Middlebrooks. Energy Requirements for Small Flow Wastewater Treatment Systems. Reprint of CRREL SR 79-7. MCD-60, OWPO, USEPA. April 1979.

6. Wesner, G.M., et al. Energy Considerations in Municipal Wastewater Treatment, MCD-32. USEPA, Office of Water Program Operations. March 1977.

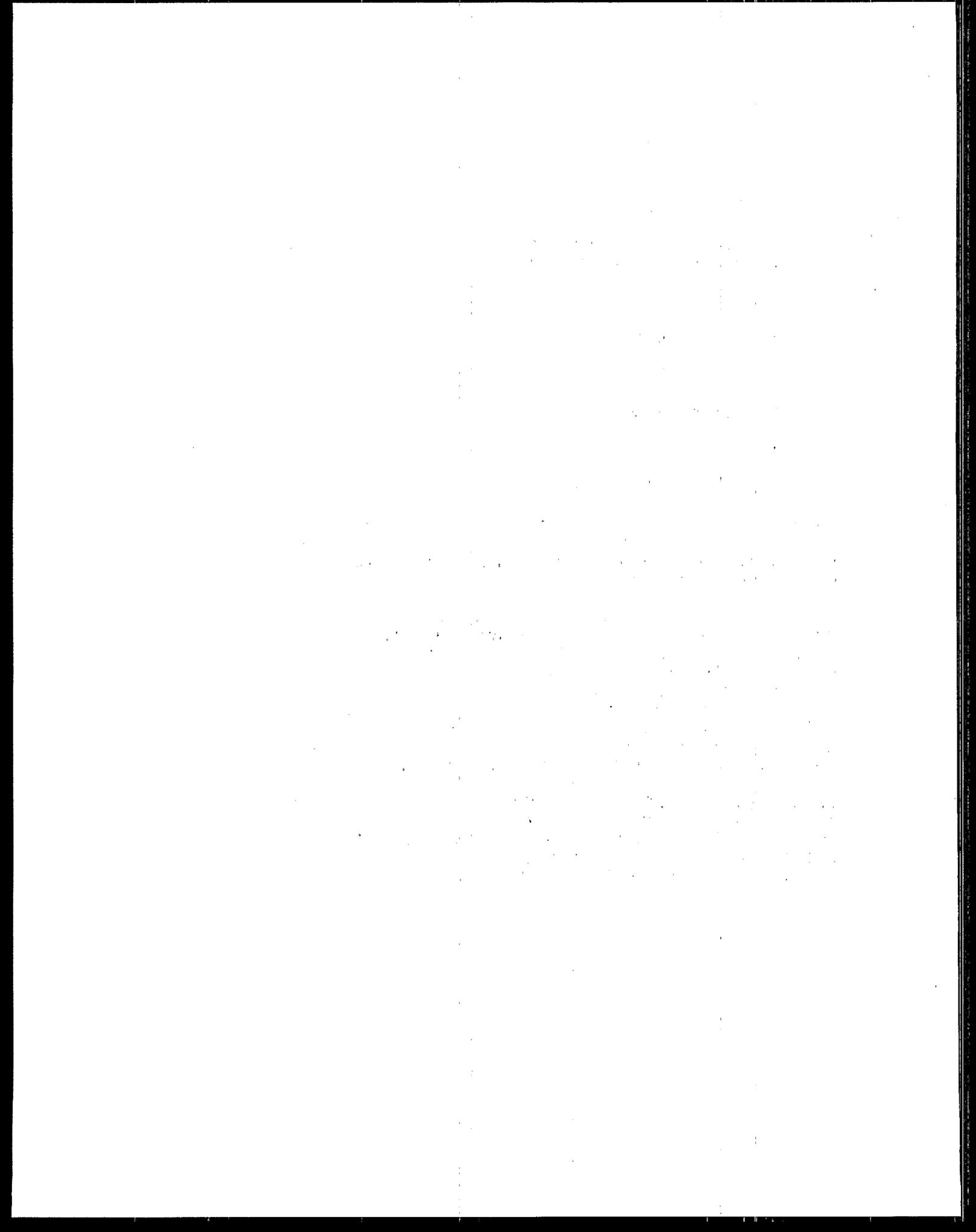

Chapter 9

HEALTH AND ENVIRONMENTAL EFFECTS

9.1 Introduction

Wastewater constituents that are of major concern for health or environmental reasons are:

- Nitrogen
- Phosphorus
- Dissolved solids
- Trace elements
- Microorganisms
- Trace organics

Potential effects of these constituents vary among the three major types of land treatment, as shown in Table 9-1. The relationship of wastewater constituents to health effects is presented in Table 9-2.

In general, constituent removals are greatest for SR systems. Health and environmental effects of RI systems depend on site selection and design factors such as hydraulic loading rate and length of application and resting cycles. Overland flow has the fewest potential impacts on ground water because very little water penetrates below the soil surface. However, renovated water from OF systems is normally discharged to local surface waters as a point source, and, therefore, can affect surface water quality.

Recently, the EPA has funded extensive studies at several operating land treatment systems to evaluate potential long-term health and environmental effects. The ten study sites are presented in Table 9-3. Results from these and other studies are included in this chapter.

TABLE 9-1
LAND TREATMENT METHODS AND CONCERNS [1]

Potential Concerns	SR	RI	OF
Nitrogen			
Health: drinking water aquifers	X	X	--
Environment: eutrophication	X	X	X
crops	X	--	--
Phosphorus			
Environment: eutrophication	X	X	X
Dissolved solids			
Health: drinking water aquifers	X	X	--
Environment: soils	X	X	X
crops	X	--	X
ground water	X	X	--
Trace elements			
Health: drinking water aquifers	X	X	--
crops	X	--	X
Environment: crops	X	--	--
animals	X	--	X
Microorganisms			
Health: drinking water aquifers	X	X	--
crops	X	--	X
aerosols	X	--	X
Environment: animals	X	--	X
Trace organics			
Health: drinking water aquifers	X	X	--
crops	X	--	--

Note: An X in the matrix indicates the possibility for concern. The magnitude of the impact is not considered.

TABLE 9-2
RELATIONSHIP OF POLLUTANTS TO HEALTH EFFECTS^a

Pollutant (agent)	Principal health effect
Nitrate nitrogen	Methemoglobinemia
Sodium	Cardiovascular
Trace elements	Toxicity
Microorganisms	Infection, disease
Bacteria	
Virus	
Protozoa	
Helminths	
Trace organics	Toxicity, carcinogenesis

a. Adapted from reference [2].

TABLE 9-3
EPA LONG-TERM EFFECTS STUDIES

Location	Date operation started	Flow during study, m ³ /s	Level of preapplication treatment	Crops	Hydraulic loading rate, m/yr
<u>Slow rate systems</u>					
Camarillo, California [3]	1966	0.130	Secondary (activated sludge) with disinfection	Tomatoes, broccoli	1.6
Dickinson, North Dakota [4]	1959	0.044	Secondary (aerated ponds) with disinfection	Forage grasses	1.4
Mesa, Arizona [5]	1950	0.208	Secondary (trickling filters)	Grain, corn, barley	4-8.6
Roswell, New Mexico [6]	1944	0.175	Secondary (trickling filters followed by oxidation ditch) with disinfection	Corn, alfalfa, sorghum	0.8
San Angelo, Texas [7]	1959	0.241	Primary	Forage grasses, pasture	2.9
Tooele, Utah [8]	1967	0.061	Secondary (trickling filters) with disinfection	Forage grasses, alfalfa. Test plots of beans, carrots, lettuce, peas, radishes, sweet corn, wheat	0.6
<u>Rapid infiltration systems</u>					
Hollister, California [9]	1945	0.044	Primary	--	15
Lake George, New York [10]	1939	0.058	Secondary (trickling filters)	--	43
Milton, Wisconsin [11]	1957	0.013	Secondary (activated sludge)	--	224
Vineland, New Jersey [12]	1926	0.215	Primary	--	19

Note: See Appendix G for metric conversions.

9.2 Nitrogen

Both nitrates and ammonia are of concern in land treatment systems. Other nitrogen compounds either are harmless or are degraded during land treatment.

Storage ponds can be used in conjunction with land treatment to achieve high nitrogen removals. Although such ponds work well for SR and OF systems, the resulting algal growth may cause soil clogging at RI systems. The use of storage ponds for nitrogen removal is described in greater detail in Section 4.4.1.

9.2.1 Crops

In the general case, nitrogen is beneficial for crops, increasing yields and quality. However, uptake of excess nitrogen in some crops can increase succulence beyond desirable levels causing lodging in grain crops and reduced sugar content in beets and cane, for example. High levels of nitrogen or application beyond seasonal needs may induce more vegetative than fruit growth, and also delay ripening. High nitrate content in forages can be a concern if these are the principal ration for livestock. Cattle can also suffer from grass tetany, which is related to an imbalance of nitrogen, potassium, and magnesium in pasture grasses. These potential nitrogen related crop effects are not expected with typical municipal wastewaters applied to properly designed and well managed land treatment systems.

9.2.2 Ground Water

As indicated in previous chapters, EPA guidance requires a maximum contaminant level (MCL) of 10 mg/L nitrate as nitrogen at the land treatment boundary. This is to avoid the potential of methemoglobinemia in very young infants using the water supply. As a result, nitrogen is often the limiting parameter for land treatment design. Methods to satisfy this requirement are described in the design chapters (Sections 4.5.2 and 5.4.3.1).

9.2.3 Surface Water

Un-ionized ammonia is toxic to several species of young freshwater fish. The oxygen carrying capacity of certain fish can be impaired at concentrations as low as 0.3 mg/L un-ionized ammonia (approximately 2.5 mg/L total ammonia nitrogen at normal pH values) [13]. For this reason, many land treatment systems that discharge to surface waters are designed to provide nitrification. Using normal application rates, OF and SR systems produce a well nitrified effluent. Renovated water from RI systems contains very little ammonia nitrogen if relatively short application periods are alternated with somewhat longer drying periods (Table 5-13).

Land treatment systems that discharge to surface waters in which nitrogen is the limiting nutrient are designed to achieve nitrogen removal to avoid algal blooms and increased rates of eutrophication. Methods for achieving nitrogen removal are described in Sections 4.5.2, 5.4.3.1, and 6.5.2.

9.3 Phosphorus

Phosphorus is not known to cause adverse health effects. Like nitrogen, it is an important nutrient for crops. Because there are no drinking or irrigation water standards, the principal concern is that phosphorus can be the limiting nutrient that controls eutrophication of surface waters.

9.3.1 Soils

The principal phosphorus removal mechanisms at SR and RI systems are soil adsorption and precipitation. Removals achieved at operating SR and RI systems are shown in Tables 4-3 and 5-3.

9.3.2 Crops

Normal crop uptake of phosphorus occurs in both SR and OF systems with loadings far in excess of crop needs. No adverse effects on crops from phosphorus have been reported.

9.3.3 Ground Water

Phosphorus concentrations found in percolates from SR and RI systems are presented in Tables 4-3 and 5-3. As shown in these two tables, percolate phosphorus concentrations are reduced substantially within relatively short travel distances.

9.3.4 Surface Water

Because phosphorus concentrations in SR and RI percolates generally are quite low (less than 1 mg/L), adequate phosphorus removal usually occurs before any percolate intercepts surface water. At OF systems, where phosphorus removal averages 50 to 60%, additional treatment may be necessary if phosphorus is limited by the discharge permit.

9.4 Dissolved Solids

Salt concentrations in domestic wastewater vary widely, according to the salinity of the local water source and the chemicals added during preapplication treatment (if any). Depending on the salinity of the applied wastewater, soil properties, crops, and water for livestock and human consumption may be affected.

9.4.1 Soils

High concentrations of sodium in applied wastewater can cause substitution of sodium ions for other cations in the

soil. This substitution tends to disperse clay particles within the soil, leading to decreased permeability, lowered shear strength, and increased compressibility [14]. Wastewater with an SAR of less than 4 has caused no changes in these properties [8]. No adverse soil impacts are expected unless the SAR exceeds 9.

9.4.2 Crops

Salinity, as measured by the electrical conductivity of the water, can cause yield reductions in crops. Crops vary widely in tolerance to salinity. The salinity tolerances and leaching requirements of several field and forage crops are given in Table 9-4. Salinity effects are generally only of concern in arid regions where accumulated salts are not flushed from the soil profile by natural precipitation. No salinity problems have been reported at the systems listed in Table 9-3.

Boron toxicity can occur because this element tends to be unaffected by most preapplication treatment processes. Fruit and citrus trees are affected at 0.5 to 1.0 mg/L; field crops can be affected at 1.0 to 2.0 mg/L; and most grasses are relatively tolerant at 2.0 to 10.0 mg/L.

Sodium and chloride ions are usually present together in wastewaters. Most tree crops are sensitive to sodium and chloride taken up by the roots. Leaves of many crops may show leaf-burn due to excessive sodium or chloride adsorption or bicarbonate deposition under low-humidity, high-evaporation conditions. Irrigating at night or increasing the rotation speed of sprinkler heads can help avoid these problems.

9.4.3 Ground Water

The salinity of percolate from some systems may limit the potential for reuse of renovated water. National drinking water standards recommend that finished potable water contains less than 500 mg/L total dissolved solids (TDS), but more saline waters have been used without ill effects. Excessive TDS can cause poor taste in drinking water, may have laxative effects on consumers, and may corrode equipment in water distribution systems. Salinity restrictions on water for livestock uses are not as stringent as for drinking water. In general, a TDS of 10,000 mg/L is the upper limit for healthy larger animals such as cows and sheep; a limit of 5,000 mg/L TDS should be used for smaller animals (including poultry), lactating animals, and young animals [13].

TABLE 9-4
TOLERANCE OF SELECTED CROPS TO
SALINITY IN IRRIGATION WATER [15]

	Yield decrement to be expected due to salinity of irrigation water						Maximum EC _{dw} , mmho/cm
	0%			50%			
	EC _e , mmho/cm	EC _w , mmho/cm	LR, %	EC _e , mmho/cm	EC _w , mmho/cm	LR, %	
<u>Field crops</u>							
Barley	8	5.3	12	18	12	27	24
Sugarbeets	6.7 ^a	4.5	11	16	10.7	26	42
Cotton	6.7	4.5	11	16	10.7	26	42
Safflower	5.3	3.5	12.5	14	8	28.5	28
Wheat	4.7 ^a	3.1	8	14	9.3	23	40
Sorghum	4	2.7	7.4	12	8	22	36
Soybean	3.7	2.5	10	9	6	23	26
Rice (paddy)	3.3	2.2	9	8	5.3	22	24
Corn	3.3	2.2	12	7	4.7	26	18
Sesbania	2.7	1.8	7	9	6	23	26
Broadbean	2.3	1.5	8	6.5	4.3	24	18
Flax	2	1.3	7	6.5	4.3	24	18
Beans (field)	1	0.7	6	3.5	2.3	19	12
<u>Forage crops</u>							
Bermudagrass	8.7	5.8	13	18	12	27	44
Tall wheatgrass	7.3	4.9	11	18	12	27	44
Crested wheatgrass	4	2.7	6	18	12	27	44
Tall fescue	4.7	3.1	8	14.5	9.7	24	40
Barley (hay)	5.3	3.5	10	13.5	9	25	36
Perennial rye	5.3	3.5	10	13	8.7	24	36
Harding grass	5.3	3.5	10	13	8.7	24	36
Birdsfoot trefoil	4	2.7	10	10	6.7	24	28
Beardless wild rye	2.7	1.8	6	11	7.3	26	28
Alfalfa	2	1.3	5	8	5.3	19	28
Orchardgrass	1.7	1.1	4	8	5.3	20	26
Meadow foxtail	1.3	0.9	4	6.5	4.3	18	24
Clover	1.3	0.9	6	4	2.7	19	14

Notes:

EC_e = electrical conductivity of saturation extract.

EC_w = electrical conductivity of irrigation water.

LR = leaching requirement: that fraction of the irrigation water that must be leached through the active root zone to control soil salinity at the tolerance level. This is in addition to the irrigation water taken up by the plants. $LR = EC_w \times 100 / EC_{dw}$. (For an approximate conversion to TDS, mg/L, or ppm, multiply mmho/cm by 640.)

EC_{dw} = maximum concentration of salts in drainage water that can be tolerated by crop. At 100% efficiency, applied water (needed to satisfy ET + LR) is equal to $ET / (1 - LR)$.

Conversion from EC_w to EC_e assumes that irrigation water salts increase three fold in salinity in becoming soil water salts (EC_{sw}). This occurs in the more active part of the root zone due to ET. ($EC_w \times 3 = EC_{sw}$; $EC_{sw} + 2 = EC_e$)

a. Tolerance during germination (beets) or early seedling stage (wheat, barley) is limited to EC_e = about 4 mmho/cm in the upper soil area where germination and early growth take place.

If the salinity of a community's wastewater is significantly higher than the salinity of the ground water, land treatment may be limited to processes that discharge to surface waters or renovated water recovery may be required to protect ground water quality. This condition occurs most frequently in the arid western states where water resources are limited and protection of ground water from increasing salinity is a major concern.

9.5 Trace Elements

Trace elements (heavy metals) in municipal wastewaters are contributed by both domestic and industrial dischargers; contributions vary widely with industry. Frequently, trace element concentrations in municipal wastewaters are lower than the limits established for drinking water. Therefore, in most communities, land treatment is unlikely to cause direct adverse health or environmental effects [16].

The fate of trace elements during land treatment is a concern primarily for two reasons:

- Trace elements, particularly cadmium, can accumulate in the food chain.
- Trace elements can move through soil and enter ground water.

9.5.1 Soils

Movement of trace elements into and through the soil may occur during wastewater application or after land treatment operations have ceased. For this reason, it is important to understand removal mechanisms and the conditions that influence retention in and transport through the soil (see Sections 4.2.4 and 5.2.4).

Concentrations of trace elements retained in the soil profile at SR and RI sites are highest near the soil surface and decrease with depth [17]. Removal efficiencies at selected systems are presented in Tables 4-4 and 5-4. Soils can retain a finite amount of trace elements; the capacity or design life for metals removal is at least the same order of magnitude as for phosphorus. For example, in typical New England soils, the design life for copper and cadmium based only on ion exchange capacity could be several hundred years using an SR system and seasonal wastewater application [1].

At OF systems, trace elements are adsorbed at the soil surface in the organic layer of decomposing organic material and plant roots. Because adsorption occurs as the applied

wastewater flows across the soil surface, metals tend to accumulate near the point of wastewater application. In pilot studies near Utica, Mississippi, approximately 50% of the monitored trace elements (cadmium, copper, nickel, and zinc) was removed on the upper third of the treatment slope [18]. Data from the same pilot studies, presented in Table 9-5, indicate that most of the trace elements entering this system are retained near the soil surface. The system has not approached its full capacity for trace element removal.

TABLE 9-5
 MASS BALANCE OF TRACE ELEMENTS IN OF
 SYSTEM AT UTICA, MISSISSIPPI [18]

Metal	Component	Grams	Percent of applied
Cadmium	Applied	46.21	
	Grass	0.54	1.2
	Runoff	3.50	7.6
	Soil	42.14	91.2
Copper	Applied	90.39	
	Grass	3.59	4.0
	Runoff	13.13	14.5
	Soil	73.67	81.5
Nickel	Applied	110.11	
	Grass	1.50	1.4
	Runoff	5.20	4.7
	Soil	103.39	93.9
Zinc	Applied	264.05	
	Grass	20.03	7.6
	Runoff	32.06	12.1
	Soil	212.03	80.3

The results of one study on an abandoned RI basin are reported in Table 5-5. These data, collected approximately 1 year after the last wastewater application, indicate that relatively little leaching occurred both during the 33 years of operation and in the year following operation. Leaching should not be a problem provided a soil pH of at least 6.5 is maintained. At this pH, most trace elements are precipitated as insoluble compounds. Methods for adjusting soil pH are discussed in Section 4.9.1.3.

9.5.2 Crops

Bioconcentration of trace elements in the food chain is most likely to occur during the operational years of a land treatment system. Plant uptake of trace elements occurs when the elements are present in soluble or exchangeable

form in the root zone. Generally, this occurs in increasing amounts as more adsorption sites are occupied and as the soil pH decreases. To minimize the plant uptake of trace elements, the soil pH should be maintained at 6.5 or above. The trace elements that are of greatest concern are cadmium, copper, molybdenum, nickel, and zinc.

With regard to health effects, nickel and zinc are of least concern because they cause visible adverse effects in plants before plant concentrations are high enough to be of concern to animals or man. Cadmium, copper, and molybdenum all may be harmful to animals at concentrations that are too low to visibly affect plants. Copper is not a health hazard to man or monogastric animals, but can be toxic to ruminants (cows and sheep). These animals' tolerance for copper increases as available molybdenum increases. Molybdenum itself may cause adverse effects in animals at 10 to 20 ppm in forage that is low in copper [13]. Cadmium is toxic to both man and animals in doses as low as 15 ppm, but ruminants absorb very small proportions of the cadmium they ingest. Once absorbed, however, this metal is stored in the kidneys and liver [19], so that most meat and milk products remain unaffected by high cadmium concentrations ingested by livestock [13].

With regard to effects on crops, trace elements have not caused any adverse effects on any of the crops grown at the SR systems listed in Table 9-3. Similarly, analyses of forage crops grown at the Melbourne, Australia, system, which has operated since 1896, show relatively little increase in trace element uptake over forage crops irrigated with potable water [20]. Typical trace element concentrations in forage grasses are presented in Table 9-6 with concentrations in forage crops grown at selected SR sites.

At the OF site near Utica, trace elements have had no adverse effects on the grasses grown. As with the soil in this system, grass uptake of trace elements is greatest near the point of wastewater application and decreases with distance down the treatment slope. Grass uptake accounted for only 1.2, 1.4, 4.0, and 7.6% of the applied cadmium, nickel, copper, and zinc, respectively [18]. If trace element uptake is a concern, the use of *Festuca rubra* (red fescue) at OF systems is recommended because trace element uptake by this plant is approximately a third the trace element uptake of most grasses [18].

TABLE 9-6
TRACE ELEMENT CONTENT OF FORAGE GRASSES AT
SELECTED SR SYSTEMS [4, 7, 21]
ppm

Trace element	Typical range	Melbourne, Australia		Dickinson, North Dakota		San Angelo, Texas
		Control site	Wastewater irrigated forage	Control site	Wastewater irrigated forage	Wastewater irrigated forage
Boron	1.0-80	NT ^a	NT	14.1	19.6	NT
Cadmium	0.2-0.8	0.77	0.64-1.28	<5	<5	0.2-0.5
Chromium	0.1-0.5	6.9	6.9-28	2	<5	<0.5-1.5
Cobalt	0.05-0.5	<0.64	<0.64-1.28	<1	<1	NT
Copper	2.0-15	6.5	11-19	7.4	6.8	3.8-9.1
Iron	250-600	970	361-987	NT	NT	NT
Lead	0.1-10	<2.5	<2.5	<5	<5	NT
Manganese	15-200	149	44-54	53	78	NT
Molybdenum	0.1-4.0	NT	NT	<0.05	<0.05	NT
Nickel	0.1-3.5	2.7	2.7-9.1	<0.5	<0.5	1.2-4.0
Zinc	8.0-60	50	58-150	22	37	10-61

a. Not tested.

9.5.3 Ground Water

Trace elements in ground water can limit its use for drinking or irrigation purposes. For this reason, the potential for trace element contamination of ground water is a concern at SR and RI systems overlying potable aquifers or aquifers that can be used as irrigation water supplies. Drinking and irrigation water standards are presented in Table 9-7.

The most toxic metals to man--cadmium, lead, and mercury--were demonstrably absent in the percolate at five of the six SR sites listed in Table 9-3; the sixth site gave inconclusive data because fallout from nearby smelters contaminated the soils. Concentrations of the metals have not approached toxic levels in any of the sites studied after up to 50 years of operation.

Cadmium, lead, and mercury concentrations in shallow ground water were comparable to concentrations in control wells at two of the three RI sites where trace metals were monitored [17]. At Hollister, shallow ground water concentrations of cadmium and lead were only slightly higher than control well concentrations and were well within drinking water standards. At the sites studied, trace element contamination of ground water has not been a problem. As long as the soil pH is maintained at 6.5 or higher, ground water contamination is likely to remain nonexistent.

TABLE 9-7
TRACE ELEMENT DRINKING AND IRRIGATION
WATER STANDARDS [8, 13, 22-27]
mg/L

	Drinking water	Irrigation water		
		For fine textured soils ^a	For any soil ^b	For livestock
Aluminum (Al)	--	20 ^c	--	5 ^c
Antimony (Sb)	0.145 ^d	--	--	--
Arsenic (As)	0.05 ^e	2 ^c	0.1 ^c	0.2 ^c
Barium (Ba)	1.0 ^e	--	--	--
Beryllium (Be)	--	0.5 ^c	0.1 ^c	--
Boron (B)	--	0.75 ^c	2 ^c	5.0 ^c
Cadmium (Cd)	0.01 ^e	0.05 ^c	0.01 ^c	0.05 ^c
Chromium (Cr ⁺⁶)	0.05 ^e	1.0 ^c	0.1 ^c	1.0 ^c
Cobalt (Co)	--	5 ^c	0.5 ^c	1.0 ^c
Copper (Cu)	1.0 ^f	5 ^c	0.2 ^c	0.5 ^c
Iron (Fe)	0.3 ^f	20 ^c	5 ^c	--
Lead (Pb)	0.05 ^e	10 ^c	5.0 ^c	0.1 ^c
Manganese (Mn)	0.05 ^f	10.0 ^c	0.02 ^c	--
Mercury (Hg)	0.002 ^e	--	--	0.01 ^c
Molybdenum (Mo)	--	0.05 ^c	0.01 ^c	--
Nickel (Ni)	--	2.0 ^c	0.2 ^c	--
Selenium (Se)	0.01 ^e	0.02 ^c	0.02 ^c	0.05 ^c
Silver (Ag)	0.05 ^e	4-8 ^g	--	--
Thallium (Tl)	0.004 ^d	--	--	--
Vanadium (V)	--	1.0 ^c	0.1 ^c	0.1 ^c
Zinc (Zn)	5 ^f	10 ^c	2 ^c	25 ^c

- a. Normal irrigation practice for 20 years.
- b. Normal irrigation practice, no time limit.
- c. Recommended Water Quality Standards, 1972 Report to EPA on Water Quality Criteria.
- d. EPA Toxic Pollutants Standards for Human Health.
- e. EPA Primary Drinking Water Standards.
- f. EPA Secondary Drinking Water Standards.
- g. EPA Recommended Irrigation Water Standards.

9.6 Microorganisms

Three classes of microorganisms can be pathogenic to man and animals:

- Bacteria
- Viruses
- Parasitic protozoa and helminths

Several approaches have been used at land treatment systems to minimize the public health impacts of pathogens. Many SR and RI systems use primary sedimentation prior to land treatment, thereby removing most helminths. Holding ponds also can be used before land treatment to inactivate most pathogens. Generally, a long detention time (about 30 days) and moderate temperatures are required for effective pathogen removal (Section 4.4.1). Many SR and RI systems rely on the filtering capacity of the soil to remove bacteria, helminths, and protozoa, and on soil adsorption for virus removal.

There are five potential pathways for pathogen transport from land treatment systems:

- Soils
- Crops
- Ground water
- Surface waters
- Aerosols

9.6.1 Soils

Straining and microbiological activity are the primary mechanisms for bacterial removal as wastewater passes through soil. Finer soils, of course, tend to have higher capacity for pathogen removal. Depending on the particular system design, there will be either a mat on top of or a zone within the soil where intense microbiological activity occurs. Here, bacteria, protozoa, and helminths and their eggs are removed by straining and the predations of other organisms, which consume the dead organisms along with the BOD in the applied wastewater and convert them primarily to carbon dioxide and ammonia. No lasting adverse effects to soil have been noted that result from these organisms.

Bacteria removal in the finer textured soils commonly encountered at SR systems is usually quite high (as shown in Table 4-6). Research has shown that complete bacteria removal generally occurs within the top 1.5 m (5 ft) of the soil profile [28]. Similar research has indicated that die-off occurs in two phases: during the first 48 hours following wastewater application, 90% of the bacteria died; the remainder of the bacteria died during the following 2 weeks [29].

Removal efficiencies at selected RI systems are presented in Table 5-6. As indicated by this table, effective bacteria removals are achieved at RI sites when adequate soil travel distance is provided.

At OF sites, bacteria are removed near the soil surface by filtration, biological predation, and ultraviolet radiation. Fecal coliform removals in excess of 95% can be obtained by maximizing the OF residence time (increasing the removal of suspended solids) and applying wastewater at a slow and relatively continuous rate [30]. For example, daily application of wastewater for extended periods (12 to 18 hours) results in better removal efficiency than shorter application periods (6 hours) alternated with weekend drying.

Adsorption is the primary mechanism for virus removal at land treatment systems. Virus removal at SR systems is quite effective. Virus removal at RI sites depends on initial concentration, hydraulic loading rate, soil type, and distance traveled through the soil. Virus transmission through soil at RI systems is presented in Table 9-8. Removal at OF sites is generally the same order of magnitude as virus removal during conventional secondary treatment.

It is possible for parasite eggs, such as *Ascaris* and helminths, to survive for months to years in soil. Although no conclusive evidence has been found to link transmission of parasitic infections to operating land treatment systems, vegetables that will be consumed raw should not be grown at land treatment sites for at least 1 to 2 years after land treatment operations are terminated.

9.6.2 Crops

In the United States, the use of wastewater for irrigation of crops that are eaten raw is not common. At present, crops usually grown include fiber, feed, fodder, and processed grains. No incidents of infection resulting from crops receiving wastewater have been identified in the United States. Sewage farms in Paris apply raw wastewater to fruit and vegetable crops (not eaten raw) which are approved for public consumption by the Ministry of Health, with no reported health problems.

Systemic uptake of pathogens by crops and subsequent transmission through the food chain is not a problem. When extremely high concentrations of viruses were applied to damaged roots and leaves, plants did take up organisms along with water and nutrients [31]. Several studies performed using typical wastewaters on undamaged crops show no pathogen uptake [4, 6].

TABLE 9-8
VIRUS TRANSMISSION THROUGH SOIL AT
RI SYSTEMS [1]

Location	Sampling distance, m	Virus concentration, PFU/L	
		At source	At sample point
Phoenix, Arizona (Jan-Dec 1974)	3-9	8	0
		27	0
		24	0
		2	0
		75	0
Gainesville, Florida (Apr-Sep 1974)	7	0.14 (avg over study period)	0.005
		0.14 (avg over study period)	0
		0.14 (avg over study period)	0
		0.14 (avg over study period)	0
		0.14 (avg over study period)	0
		0.14 (avg over study period)	0
		0.14 (avg over study period)	0
Santee, California (1966)	61	Concentrated type 3 polio	0
Ft. Devens, Massachusetts (1974)	17	Indigenous virus, 276 (avg)	8.3 (avg)
		f ₂ bacteriophage seed, 2.2 x 10 ⁵	1.3 x 10 ⁵
Medford, New York (Nov 1976-Oct 1977)	0.75-8.34	Indigenous virus, 1.1-81.0	17 samples negative; 6 positive, at 0.47 (avg); range 0.14-0.66
		0.75	Polio virus seed, 7 x 10 ⁴ (6 cm/h infiltration rate)
		0.75	1.84 x 10 ⁵ (100 cm/h infiltration rate)
Vineland, New Jersey (Aug 1976-May 1977)	0.6-16.8	13 (avg over study period)	9 of 10 positive, 1.62 avg
		13 (avg over study period)	7 of 10 positive
		13 (avg over study period)	2 of 10 positive, 1.95 avg
		13 (avg over study period)	0 of 10 positive, 0.48 avg

When wastewater is applied by sprinklers, the potential exists for pathogens to survive on the surface of a plant. Sunlight is an effective disinfectant, killing pathogens in a few hours to a few days; but any place that stays warm, dark, and moist could harbor bacteria. For this reason, wastewater is not used to irrigate crops that are eaten raw unless a very high degree of preapplication treatment is provided. To protect livestock, grazing should not be allowed on pasture irrigated with disinfected pond or secondary effluent for 3 to 4 days following wastewater application. At least 1 week should be allowed between applications of primary effluent and grazing. Longer resting periods are recommended for cold, northern climates, particularly when forage crops such as Reed canarygrass, orchardgrass, and brome grass are irrigated [29, 32].

The National Technical Advisory Committee on Water Quality advises a standard of 1,000 fecal coliforms/100 mL for water used in agriculture [20]. Even lower fecal coliform

concentrations can be achieved, without disinfection, by settling and storing the effluent before application (Section 4.4.1).

9.6.3 Ground Water

Because viruses can survive outside an animal host for longer periods of time than bacteria and other pathogens, and because ingestion of only a few viruses may cause disease, virus transmission is the primary concern when evaluating the ground water pathway. Other pathogens are removed largely by filtration or natural die-off before they have an opportunity to migrate into ground water. Although no viral standards have been established, SR and RI systems that discharge to potable aquifers are designed to meet the bacterial standard listed in Table 2-4. The intent of this standard is to ensure that renovated water is essentially bacteria- and virus-free.

As indicated in Section 9.6.1, virus removal at SR systems is quite effective, mainly due to the adsorptive capacity of soils used for SR systems. Thus, most research on virus transmission has been focused on RI systems and coarser textured soils, such as the studies summarized in Table 9-8. As indicated in this table, viruses can enter ground water, particularly when large virus concentrations are applied at high loading rates to very permeable soils. However, the number of viruses that are transmitted is low, and the risk to potential consumers is minimal provided adequate distance between the treatment site and any ground water wells is maintained.

Coliform levels found in ground water underlying SR and RI systems are shown in Tables 4-6 and 5-6. These tables indicate that over 99% of the applied coliforms is removed within short travel distances. Provided adequate distance is allowed, it is possible for any well-operated SR or RI system to meet the coliform standard for drinking waters.

9.6.4 Surface Water

Land treatment systems that discharge to surface waters used for drinking, irrigation, or recreation must meet local discharge standards for microorganisms. As mentioned previously, SR and RI systems should have no problems meeting discharge standards. The microbiological quality of renovated water from OF systems generally is comparable to effluent from conventional secondary treatment systems without chlorination. Bacteria removals of 90 to 95% or higher and virus removals of 70 to 90% are typical at OF systems (Section 6.2.6).

9.6.5 Aerosols

Aerosols are very small airborne droplets, less than 20 microns in diameter, that may be carried beyond the range of discernible droplets from sprinklers. Sprinkler generated aerosols are slightly smaller than ambient aerosols; two-thirds to three-fourths of the sprinkler generated aerosols are in the potentially respirable size range of 1 to 5 microns [33]. Aerosols may carry bacteria and viruses, but do not normally contain pathogenic protozoa or helminths and their eggs. Aerosols may come from sources other than wastewater treatment sites, such as cooling towers and public facilities. As a result of these other sources, ambient bacterial concentrations in the air of some cities are comparable to the concentrations found near land treatment sprinkler zones.

As aerosols are generated, they are immediately subjected to an "impact factor" that may reduce bacteria concentrations by 90% and virus concentrations by 70% within seconds [2]. Further reduction may be caused by desiccation, temperature, deposition, and solar radiation. Aerosol dispersion, influenced by wind speed, air turbulence, and local topography, occurs concurrently.

The concentration of bacteria and viruses in aerosols is a function of their concentration in the applied wastewater and the aerosolization efficiency of the spray process. The latter of these factors depends on nozzle size, pressure, angle of spray trajectory, angle of spray entry into the wind, and impact devices [34]. Studies have shown that approximately 0.32% of the liquid leaving the nozzle is aerosolized [35].

Bacteria cannot be detected in aerosols at distances of even 10 m (33 ft) from sprinklers unless the bacteria concentrations in the applied wastewater are at least 10^3 to 10^4 /mL, [36]. When undisinfected wastewater is sprinkler applied, aerosol bacteria have been found to travel a maximum distance of 400 m (1,312 ft) from a sprinkler line [37]. Under some conditions, viruses have been detected at distances of up to 100 m (328 ft) [2]. Concentrations of bacteria and enteroviruses that have been detected near various SR land treatment sites are shown in Tables 9-9 and 9-10.

TABLE 9-9
AEROSOL BACTERIA AT LAND
TREATMENT SITES [2]

Wastewater type	Location	Distance downwind from site, m	Bacteria	Density range ^a , No./m ³
Raw or primary	Germany	90-160 ^b	Coliforms	--
	Germany	63-400 ^{b,c}	Coliforms	--
	California	32 ^b	Coliforms	--
	Kibbutz Tzora, Israel	10	Coliforms	11-496
		10	Fecal coliforms	35-86
		20	Coliforms	0-480
		60	Coliforms	0-501
		70	<u>Salmonella</u>	
		100	Coliforms	30-102
		150	Coliforms	0-88
		200	Coliforms	4-32
		250	Coliforms	0-17
		300	Coliforms	0-21
		350	Coliforms	0-7
		400	Coliforms	0-4
Ponded, chlorinated	Deer Creek, Ohio	Control value	Standard plate count	23-403 (111)
		21-30	Standard plate count	46-1,582 ^d (485)
		41-50	Standard plate count	0-1,429 ^d (417)
		200	Standard plate count	<0-223 ^d (37)
Secondary, nondisinfected	Ft. Huachuca, Arizona	Control value	Standard plate count	12-170 (28)
		Control value	Coliforms	0-58 (2.4)
		45-49 ^c	Standard plate count	430-1,400 (day)
				560-6,300 (night)
		120-152 ^c	<u>Klebsiella</u>	1-23
			Standard plate count	86-130 (day)
			170-410 (night)	
	Pleasanton, California	Control value	Standard plate count	300-805
			Standard plate count	450-1,560
			Total coliforms	2.4-2.5
			Fecal coliforms	0.4
			Fecal streptococci	0.3-1.7
<u>Pseudomonas</u>			34	
100-200		<u>Klebsiella</u>	<5	
		<u>Clostridium perfringens</u>	0.9	
		<u>Mycobacterium</u>	0.8	
		Standard plate count	330-880	
		Total coliforms	0.6-1.2	
		Fecal coliforms	<0.3	
Fecal streptococci	0.3-1.9			
<u>Pseudomonas</u>	43			
<u>Klebsiella</u>	<5			
<u>Clostridium perfringens</u>	1.1			
<u>Mycobacterium</u>	0.8			

- a. Numbers in parentheses indicate mean values.
b. Distance quoted is maximum distance at which coliforms were detected.
c. Upper values occurred during night hours.
d. Corrected for upwind background value.

TABLE 9-10
AEROSOL ENTEROVIRUSES AT LAND
TREATMENT SITES [2]

Wastewater type	Location	Distance downwind from sprinkler, m	Wastewater enteroviruses, PFU/L		Aerosol enteroviruses, PFU/m ³	
			Range	Mean	Range	Mean
Nondisinfected secondary effluent	Pleasanton, California	50	45-330	188	0.011-0.017	0.014
Raw wastewater	Kibbutz Tzora, Israel	36-42	0-650	125	0-0.82	0.015
		50	--	650	--	0.14
		70	170-13,000	6,585	0-0.026	0.013
		100	0-82,000	16,466	0-0.10	0.038

The data in Tables 9-9 and 9-10 can be used to estimate human exposure to aerosol bacteria and enteroviruses. For example, a reasonable estimate may be obtained by using data from Pleasanton, California. At a distance of 50 m (164 ft) downwind from a sprinkler, an adult male engaged in light work and breathing at a rate of 1.2 m³/h (42 ft³/h) would inhale an average of 1 plaque-forming unit (PFU) of enterovirus after 59 hours of exposure. Although this represents an extremely low rate of potential viral exposure, methods for recovering enteric viruses currently are not entirely efficient and actual viral exposure may be somewhat higher [38].

As shown by the data in Table 9-11, aerosol fecal coliform concentrations are lower at SR systems than at activated sludge facilities. Thus, the risk of disease transfer from SR sites should be no greater than from activated sludge facilities. For this reason, epidemiological studies of the health effects of aerosols from activated sludge plants may be used to conservatively estimate the health effects of SR facility aerosols.

Epidemiological studies of activated sludge plants indicate that there is no significant disease rate increase for nearby populations [39-44]. Based on these studies, it does not appear that land treatment system employees or people living near sprinkler irrigation sites should anticipate a risk of disease due to aerosols.

TABLE 9-11
COMPARISON OF COLIFORM LEVELS
IN AEROSOLS AT ACTIVATED SLUDGE AND
SLOW RATE LAND TREATMENT FACILITIES [37, 45]

	Maximum	Median	Minimum
<u>Activated sludge^a</u>			
Aerosols, No./m ³			
Upwind	28	0	0
Over basins	146	14	0
Downwind ^a	141	7	0
Wastewater, No./100 mL	8×10^7	1.6×10^6	1.1×10^4
<u>Aerated pond^b</u>			
Aerosols, No./m ³			
Downwind			
30 m	452	--	4
100 m	5	--	1
150 m	4	--	--
200 m	5	--	0
250 m	4	--	0
Wastewater, No./100 mL	10^5	--	10^4
<u>Slow rate land treatment^a</u>			
Aerosols, No./m ³			
Upwind	1.0	BD ^c	BD
Downwind ^d	12.2	1.0	BD
Wastewater, No./100 mL	1.86×10^5	8.1×10^4	2.4×10^4

- a. Fecal coliform levels reported.
b. Total coliform levels reported.
c. Below detection.
d. Up to 30 m (98 ft) downwind.

If necessary, several measures can be used to further reduce bacterial and viral exposure through aerosols. First, operating sprinklers during daylight hours increases the number of microorganisms killed by ultraviolet radiation [2]. Sprinkling during early morning hours is preferable in arid or semiarid areas for water conservation purposes. Second, the use of downward-directed, low pressure sprinklers results in fewer aerosols than upward-directed high pressure sprinklers. Ridge-and-furrow irrigation or surface flooding are recommended when these application techniques are feasible [2]. Third, when public residences are near the sprinkler system, buffer zones may be used to separate the spray source and the general public. In general, public access to the irrigation site should be limited. Finally, planting vegetation around the site can reduce the aerosol concentrations leaving the site [46]. Coniferous or deciduous vegetation have achieved up

to 50% aerosol removal by filtration. Planted as a barrier, these types of vegetation should be able to reduce aerosol concentrations several orders of magnitude through vertical dispersion and dilution.

9.7 Trace Organics

Concern over trace organics arose when chlorinated hydrocarbons and other trace organics were found in potable water supplies. At land treatment sites, the concern is that trace organics may travel through the soil profile and enter drinking water aquifers or accumulate in the soil profile and be taken up by plants.

9.7.1 Soils

Many trace organics are adsorbed as they move through the soil profile at SR and RI systems. Chloroform is one such compound, as indicated in Table 4-7; other chlorinated hydrocarbons behave similarly. Although the adsorptive capacity of a soil is limited, once trace organics have been adsorbed they may be biodegraded or volatilized and released to the atmosphere. In either case, the adsorption site becomes available for adsorption of additional organic molecules.

The amount of trace organics that can be removed during movement through the soil is not well understood. Some research has been conducted in West Germany using natural sand beds to filter contaminated river water. The river water contains high concentrations of trace organics, particularly chlorinated hydrocarbons. The observed removal efficiencies are presented in Table 9-12. As shown in this table, trace organics removal can be highly effective, even in coarser soils.

TABLE 9-12
TRACE ORGANICS REMOVALS DURING
SAND FILTRATION [47]

Constituent	% removal
Chlorobenzene	96
Dichlorobenzene	45
Trichlorobenzene	12
Chlorotoluene	94
Dichlorotoluene	62
Dissolved organic chlorides	38
Dissolved nonpolar organic chlorides	73
Dissolved organic carbon	68
Benzene	80
Toluene	95

9.7.2 Crops

Plants can absorb many organic pesticides and some organophosphate insecticides through their roots, with subsequent translocation to plant foliage. Uptake of these organics is affected by the solubility, size, concentration, and polarity of the organic molecules; the organic content, pH, and microbial activity of the soil; and the climate [48]. However, a recent study on health risks associated with land application of sludge has found that the level of pesticide and herbicide absorption is quite low; not more than 3% of the molecules that were in the soil passed into plant foliage [48]. Most trace organics are too large to pass through the semipermeable membrane of plant roots. Thus, it is unlikely that crop uptake of trace organics during land treatment is significant enough to be harmful to man or animals.

9.7.3 Ground Water

As mentioned in Section 9.7.1, soil adsorption of trace organics at SR and RI sites can be an effective removal mechanism. For this reason, only low levels of trace organics would be expected to migrate to underlying ground water. The results of studies at two SR systems (Table 9-13) and two RI systems (Table 5-8) indicate that significant removals do occur at these systems with the exception of the Milton RI site which was operated at continuous (no drying) extremely high wastewater loadings. At the Milton site, high removals are achieved by the time ground water travels a distance of 45 m (160 ft) downgradient. Endrin, methoxychlor, and toxaphene were not detectable in the wastewaters of any of the four communities, and the concentrations of lindane, 2,4-D, and 2,4,5-TP silvex were all well below drinking water limits in the ground waters underlying the land treatment sites (Table 2-4).

Recent research at the Phoenix RI site has examined the removal of refractory volatile organics during RI using secondary effluent [54]. The results are presented in Table 9-14. As shown by this table, fairly high removal efficiencies were obtained (70 to 100%).

Similar research conducted at the Fort Devens RI site indicated that 80 to 100% of the applied refractory organics is removed during RI; average removal of trace organics was 96% [50]. Based on the results of these studies, it does not appear that normal concentrations of trace organics in applied wastewaters would cause problem levels in ground waters underlying SR and RI sites. Detailed studies on the

fate of trace organics during land treatment are underway at the Muskegon SR site; these studies should provide additional insight into the potential risk of ground water contamination.

TABLE 9-13
TRACE ORGANICS REMOVALS AT SELECTED SR SITES [4, 6]
ng/L

	Roswell, New Mexico		Dickinson, North Dakota	
	Wastewater	Ground water	Wastewater	Ground water
Endrin	<0.03	<0.03	<0.03	<0.03
Lindane	560	74.3	397	53.6
Methoxychlor	<0.01	<0.01	<0.01	<0.01
Toxaphene	<0.1	<0.1	<0.1	<0.1
2,4-D	29.0	10.4	17.0	6.2
2,4,5-TP silvex	28.0	25.8	93	47.1

TABLE 9-14
REMOVAL OF REFRACTORY VOLATILE ORGANICS
BY CLASS AT PHOENIX RI SITE [49]

Class (typical example)	Removal, %
Chloroalkanes (tetrachloroethylene)	70
Chloroaromatics (p-dichlorobenzene)	94
Alkyabenzenes (o-xylene)	98
Alkyaphenols (p-isopropylphenol)	85
Alkylnaphthalenes (2-methylnapthalene)	100
Alkanes (hexatriacontane)	71
Alcohols (2,4-dimethyl-3-hexanol)	95
Ketones (2,6-d-t-butyl-p-benzoquinone)	98
Indoles, Indenes (IH-indole)	96
Amides (N-[3-methylphenyl] acetamide)	74
Alkoxyaromatics (butoxymethylbenzene)	91
Weighted average	92

9.7.4 Surface Water

Discharge from the OF process will directly impact surface water in most cases. The effectiveness of trace organics removal during OF has been studied at a pilot system in Hanover, New Hampshire. Chlorinated primary effluent was used in these studies; this effluent contained 6.7 to 17.8

µg/L chloroform, 10.2 to 33.1 µg/L toluene, and lesser amounts of bromodichloromethane, 1,1,1-trichloroethane, tetrachloroethylene, and carbon tetrachloride [51]. Using a 30.5 m (100 ft) long slope with a 5% grade, chloroform and toluene removals were as presented in Table 9-15. These efficient removal rates are thought to result from volatilization as the wastewater flows over the slope or sorption near the soil surface followed by either microbial degradation or volatilization. Based on these results, it appears that volatile trace organics contamination of surface waters by renovated water from OF systems should not be a problem unless initial concentrations are excessive. Studies are underway on the removal of nonvolatile organic compounds.

TABLE 9-15
CHLOROFORM AND TOLUENE REMOVAL
DURING OF [51]

Application rate, cm/h	Concentration at various travel distances, µg/L						Total removal, %
	Waste-water	3.8 m	7.6 m	15.7 m	22.9 m	Runoff	
<u>Chloroform</u>							
0.40	17.8	12.4	6.9	3.1	--	0.3	98.3
0.60	6.7	5.7	3.8	2.1	0.9	0.5	92.5
0.80	13.2	6.4	5.9	3.7	1.5	0.8	93.9
1.05	6.7	--	5.9	4.1	--	1.1	83.6
1.32	9.0	7.8	6.8	6.1	1.4	1.9	78.9
<u>Toluene</u>							
0.40	33.1	20.7	4.9	BD ^a	--	BD	100.0
0.60	10.2	6.2	2.4	0.5	BD	BD	100.0
0.80	28.7	10.0	7.8	3.9	BD	BD	100.0
1.05	21.5	--	9.8	7.4	--	0.7	96.7
1.32	18.8	9.9	7.7	6.3	1.4	0.8	95.7

a. BD - concentration was below a detection limit estimated at 0.01 µg/L.

9.8 References

1. Reed, S., R. Thomas, and N. Kowal. Long Term Land Treatment, Are There Health or Environmental Risks? Proceedings of the ASCE National Convention, Portland, Oregon. April 1980.
2. Kowal, N.E. Health Effects of Land Treatment. Microbiological. U.S. Environmental Protection Agency, Health Effects Research Laboratory. Cincinnati, Ohio. EPA-600/1-81-055. July 1981.

3. Stone, R. and J. Rowlands. Long-Term Effects of Land Application of Domestic Wastewater: Camarillo, California, Irrigation Site. U.S. Environmental Protection Agency. EPA-600/2-80-080. May 1980.
4. Benham-Blair & Affiliates, Inc., and Engineering Enterprises, Inc. Long-Term Effects of Land Application of Domestic Wastewater: Dickinson, North Dakota, Slow Rate Irrigation Site. U.S. Environmental Protection Agency. EPA-600/2-79-144. August 1979.
5. Stone, R. and J. Rowlands. Long-Term Effects of Land Application of Domestic Wastewater: Mesa, Arizona, Irrigation Site. U.S. Environmental Protection Agency. EPA-600/2-80-061. April 1980.
6. Koerner, E.L. and D.A. Haws. Long-Term Effects of Land Application of Domestic Wastewater: Roswell, New Mexico, Slow Rate Irrigation Site. U.S. Environmental Protection Agency. EPA-600/2-79-047. February 1979.
7. Hossner, L.R., et al. Sewage Disposal on Agricultural Soils: Chemical and Microbiological Implications. U.S. Environmental Protection Agency. EPA-600/2-78-131"a" and "b." June 1978.
8. Reynolds, J.H., et al. Long-Term Effects of Land Application of Domestic Wastewater: Tooele, Utah, Slow Rate Site. 2 vols. U.S. Environmental Protection Agency. EPA-600/2-79-171"a" and "b." August 1979.
9. Pound, C.E., R.W. Crites, and J.V. Olson. Long-Term Effects of Land Application of Domestic Wastewater: Hollister, California, Rapid Infiltration Site. U.S. Environmental Protection Agency. EPA-600/2-78-084. April 1978.
10. Aulenbach, D.B. Long-Term Recharge of Trickling Filter Effluent Into Sand. U.S. Environmental Protection Agency. EPA-600/2-79-068. March 1979.
11. Benham-Blair & Affiliates, Inc., and Engineering Enterprises, Inc. Long-Term Effects of Land Application of Domestic Wastewater: Milton, Wisconsin, Rapid Infiltration Site. U.S. Environmental Protection Agency. EPA-600/2-79-145. August 1979.
12. Koerner, E.L. and D.A. Haws. Long-Term Effects of Land Application of Domestic Wastewater: Vineland, New Jersey Rapid Infiltration Site. U.S. Environmental Protection Agency. EPA-600/2-79-072. March 1979.

13. National Academy of Sciences and National Academy of Engineering, Commission on Water Quality Criteria. Water Quality Criteria, 1972. Washington, D.C.
14. Lambe, T.W. and R.V. Whitman. Soil Mechanics. John Wiley and Sons, Inc. New York. 1969.
15. Ayers, R.S. Quality of Water for Irrigation. Journal of the Irrigation and Drainage Division, ASCE 103 (IR2): 135-154. 1977.
16. Uiga, A., R.C. Fehrmann, and R.W. Crites. Relative Health Factors Comparing Activated Sludge Systems to Land Application Systems. Proceedings of the Symposium on Land Treatment of Wastewater, Hanover, New Hampshire. August 20-25, 1978.
17. Leach, L.E., C.G. Enfield, and C.C. Harlin. Summary of Long-Term Rapid Infiltration System Studies. U.S. Environmental Protection Agency. EPA-600/2-80-165. July 1980.
18. Peters, R.E., C.R. Lee, and D.J. Bates. Field Investigations of Overland Flow Treatment of Municipal Lagoon Effluent. U.S. Army Engineers Waterways Experiment Station. Vicksburg, Mississippi. September 1980.
19. Anthony, R.G., et al. Effects of Municipal Wastewater Irrigation on Select Species of Mammals. Proceedings of the Symposium on Land Treatment of Wastewater, Vol. 2, Hanover, New Hampshire. August 20-25, 1978.
20. Reed, S.C. Health Aspects of Land Treatment. Technology Transfer Seminars, Land Treatment of Municipal Wastewater Effluents. U.S. Environmental Protection Agency and U.S. Army Corps of Engineers. June 1979.
21. Seabrook, B.L. Land Application of Wastewater in Australia. U.S. Environmental Protection Agency. EPA-430/9-75-017. May 1975.
22. Federal Register. Water Quality Criteria. March 15, 1979. pp. 15926-15970.
23. Federal Register. Water Quality Criteria. July 25, 1979. pp. 43660-43697.
24. Federal Register. Water Quality Criteria. October 1, 1979. pp. 56628-56657.

25. Metcalf & Eddy, Inc. Wastewater Engineering: Treatment, Disposal, and Reuse. McGraw-Hill Book Company. New York, New York. 1979.
26. Manual of Treatment Techniques for Meeting the Interim Primary Drinking Water Regulations. U.S. Environmental Protection Agency. EPA-600/8-77-005. April 1978.
27. McKee, J.E. and H.W. Wolf. Water Quality Criteria. California Quality Control Board. Publication 3A. 1963.
28. Jenkins, T.F. and A.J. Palazzo. Wastewater Treatment by a Slow Rate Land Treatment System. U.S. Army Corps of Engineers, Cold Regions Research and Engineering Laboratory. CRREL Report 81-14. Hanover, New Hampshire. August 1981.
29. Bell, R.G. and J.B. Bole. Elimination of Fecal Coliform Bacteria from Soil Irrigated with Municipal Sewage Lagoon Effluent. Journal of Environmental Quality. 7:193-196. 1978.
30. Hoepfel, R.E., R.G. Rhett, and C.R. Lee. Fate and Enumeration Problems of Fecal Coliform Bacteria in Runoff Waters from Terrestrial Ecosystems. Technical Report EL-80-9. U.S. Army Engineer Waterways Experiment Station. Vicksburg, Mississippi. September 1980.
31. Shuval, H.I. Land Treatment of Wastewater in Israel. Proceedings of the Symposium on Land Treatment of Wastewater, Vol. 1, Hanover, New Hampshire. August 20-25, 1978.
32. Popp, L. Irrigation with Sewage from the Hygenic Point-of-View. International Commission on Irrigation and Drainage, 5th Regional Meeting. Cambridge, England. 1967.
33. Bausum, H.T., et al. Microbiological Aerosols from a Field Source During Sprinkler Irrigation with Wastewater. Proceedings of the Symposium on Land Treatment of Wastewater, Hanover, New Hampshire. August 20-25, 1978.
34. Schaub, S.A., et al. Monitoring of Microbiological Aerosols at Wastewater Sprinkler Irrigation Sites. Proceedings of the Symposium on Land Treatment of Wastewater, Hanover, New Hampshire. August 20-25, 1978.

35. Sorber, C.A., et al. A Study of Bacterial Aerosols at a Wastewater Irrigation Site. Journal WPCF. 48(10): 2367-2379. 1976.
36. Johnson, D.E., et al. The Evaluation of Microbiological Aerosols Associated with the Application of Wastewater to Land: Pleasanton, California. U.S. Environmental Protection Agency. EPA-600/1-80-015. 1980.
37. Katzenelson, E. and B. Teltsch, Dispersion of Enteric Bacteria by Spray Irrigation. Journal WPCF. 48(4)710-716. 1976.
38. Teltsch, B., et al. Isolation and Identification of Pathogenic Microorganisms at Wastewater-Irrigated Fields. Applied and Environmental Microbiology. 39:1183-1190. 1980.
39. Uiga, A. and R.W. Crites. Relative Health Risks of Activated Sludge Treatment and Slow Rate Land Treatment. Journal WPCF. 52(12):2865-2874. 1980.
40. Clark, C.S., et al. A Seroepidemiologic Study of Workers Engaged in Wastewater Collection and Treatment. Proceedings of the Symposium on Land Treatment of Wastewater, Hanover, New Hampshire. August 20-25, 1978.
41. Pahren, H.R. Wastewater Aerosols and Disease. Presented at the 53rd Annual Conference of the Water Pollution Control Federation, Las Vegas, Nevada. September 28 to October 3, 1980.
42. Carnow, B., et al. Health Effects of Aerosols Emitted from an Activated Sludge Plant. U.S. Environmental Protection Agency. EPA-600/1-79-019. 1979.
43. Crites, R.W. and A. Uiga. An Approach for Comparing Health Risks of Wastewater Treatment Alternatives - A Limited Comparison of Health Risks Between Slow Rate Land Treatment and Activated Sludge Treatment and Discharge. U.S. Environmental Protection Agency. EPA-430/9-79-009, MCD-41. 1979.
44. Pahren, H.R. and W. Jakubowski, eds. Wastewater Aerosols and Disease. U.S. Environmental Protection Agency. EPA-600/9-80-028. December 1980.

45. Sorber, C. et. al. Bacterial Aerosols Created by Spray Irrigation of Wastewater. In: Proceedings of the Sprinkler Irrigation Technical Conference, Sprinkler Irrigation Association. Rockville, Maryland. 1975.
46. Spendlove, J.C., et al. Supression of Microbial Aerosols by Vegetation. Presented at the Water Pollution Control Federation Conference, Houston, Texas. October 7-12, 1979.
47. Sontheimer, H. Experience with River Bank Filtration Along the Rhine River. Proceedings of the Symposium on Wastewater Reuse for Ground Water Recharge. Pomona, California. September 6-7, 1979.
48. Pahren, H.R., et al. Health Risks Associated with Land Application of Municipal Sludge. Journal WPCF. 51(11): 2588-2601. 1979.
49. Tomson, M.B., et al. Ground Water Contamination by Trace Level Organics from a Rapid Infiltration Site. Water Research. In Press. 1981.
50. Tomson, M.B., et al. Trace Organic Contamination of Ground Water: Methods for Study and Preliminary Results. Proceedings of the 3rd World Congress on Water Resources. Mexico City. April 23-27, 1979.
51. Jenkins, T.F., D.C. Leggett, and C.J. Martel. Removal of Volatile Trace Organics from Wastewater by Overland Flow Land Treatment. Journal of Environmental Science and Health. A15(3):211-224. 1980.

1. The first part of the document discusses the importance of maintaining accurate records of all transactions and activities. It emphasizes that this is essential for ensuring transparency and accountability in the organization's operations.

2. The second part of the document outlines the various methods and tools used to collect and analyze data. It highlights the need for consistent data collection procedures and the use of advanced analytical techniques to derive meaningful insights from the data.

3. The third part of the document focuses on the role of technology in data management and analysis. It discusses how modern software solutions can streamline data collection, storage, and processing, thereby improving efficiency and accuracy.

4. The fourth part of the document addresses the challenges associated with data management, such as data quality, security, and privacy. It provides strategies to mitigate these risks and ensure that the data remains reliable and secure throughout its lifecycle.

5. The fifth part of the document discusses the importance of data governance and the establishment of clear policies and procedures. It emphasizes that effective data governance is crucial for ensuring that data is used responsibly and in compliance with relevant regulations.

6. The sixth part of the document explores the role of data in decision-making and strategic planning. It highlights how data-driven insights can help organizations identify trends, opportunities, and risks, enabling them to make more informed and strategic decisions.

7. The seventh part of the document discusses the importance of data literacy and training for all employees. It emphasizes that having a data-literate workforce is essential for maximizing the value of the organization's data assets.

8. The eighth part of the document discusses the role of data in innovation and new product development. It highlights how data can be used to identify customer needs, test new ideas, and optimize product designs, leading to the development of more innovative and customer-centric products.

9. The ninth part of the document discusses the importance of data in measuring and improving organizational performance. It highlights how data can be used to track key performance indicators (KPIs) and identify areas for improvement, enabling the organization to achieve its strategic goals more effectively.

10. The tenth part of the document discusses the role of data in building a data-driven culture. It emphasizes that a data-driven culture is one where data is used to inform decisions and drive continuous improvement across all levels of the organization.

APPENDIX A

SLOW RATE DESIGN EXAMPLE

A.1 Introduction

This design example is presented to illustrate the procedures described in Chapter 4 for the preliminary design of slow rate (SR) systems. The example is detailed enough to allow cost comparison with other alternatives. The focus of this example is on determining the major design variables in land treatment systems including crop selection, hydraulic loading rate, land area requirements, storage requirements, and application method. Supplemental components such as pumping and headworks requirements are discussed briefly and listed for cost comparison purposes.

A.2 Statement of Problem

A.2.1 Background

City A is located in central Missouri in an area characterized by fertile soils and intensive farming. Rainfall is more plentiful than is needed for most crops, but is distributed unevenly during the year. Supplemental irrigation is beneficial to most crops in summer.

The existing wastewater treatment facility consists of a single stage trickling filter with anaerobic digestion and sludge drying beds. The facility is in poor structural condition and unable to meet present NPDES permit requirements.

A.2.2 Population and Wastewater Characteristics

Population and wastewater characteristics are presented in Table A-1. Industrial flows are expected to be nontoxic and biodegradable.

A.2.3 Discharge Requirements

Surface discharge of wastewater is prohibited for streams in the area, and the ground water aquifer is used as a drinking water source so drinking water quality will be expected at the project boundary.

TABLE A-1
POPULATION AND WASTEWATER CHARACTERISTICS

Design year	2005
Population	18,900
Average annual flow, m ³ /d	
Industrial	416
Municipal	7,154
Total	7,570
Maximum monthly avg flow, m ³ /d	9,085
Infiltration into sewers	None (nonexcessive)
Wastewater strength, mg/L	
BOD ₅	200
SS	200
Total nitrogen, mg/L (as N)	38
Total phosphorus, mg/L (as P)	8

A.2.4 Site Characteristics

The proposed site for the treatment facility is shown in Figure A-1. The site was chosen because of its isolation from population centers, its location downwind from the city, and the availability of flat, well-drained soils in the area. According to an old SCS map, shown in Figure A-1, Bosket fine sandy loam dominates the treatment site and Cooter silty clay dominates the treatment pond site. Both areas have 0 to 1% slope.

A.2.5 Climate

The area is subject to frequent changes in weather with no prolonged periods of very cold or very hot weather. The last freeze is usually in late March and the first freeze in early November.

Climatic data, obtained from the National Oceanic and Atmospheric Administration's Climatology of the United States, are shown in Table A-2 for the nearest United States No. 20 recording station to City A. The data represent the worst year in 5 for monthly average precipitation and temperature.

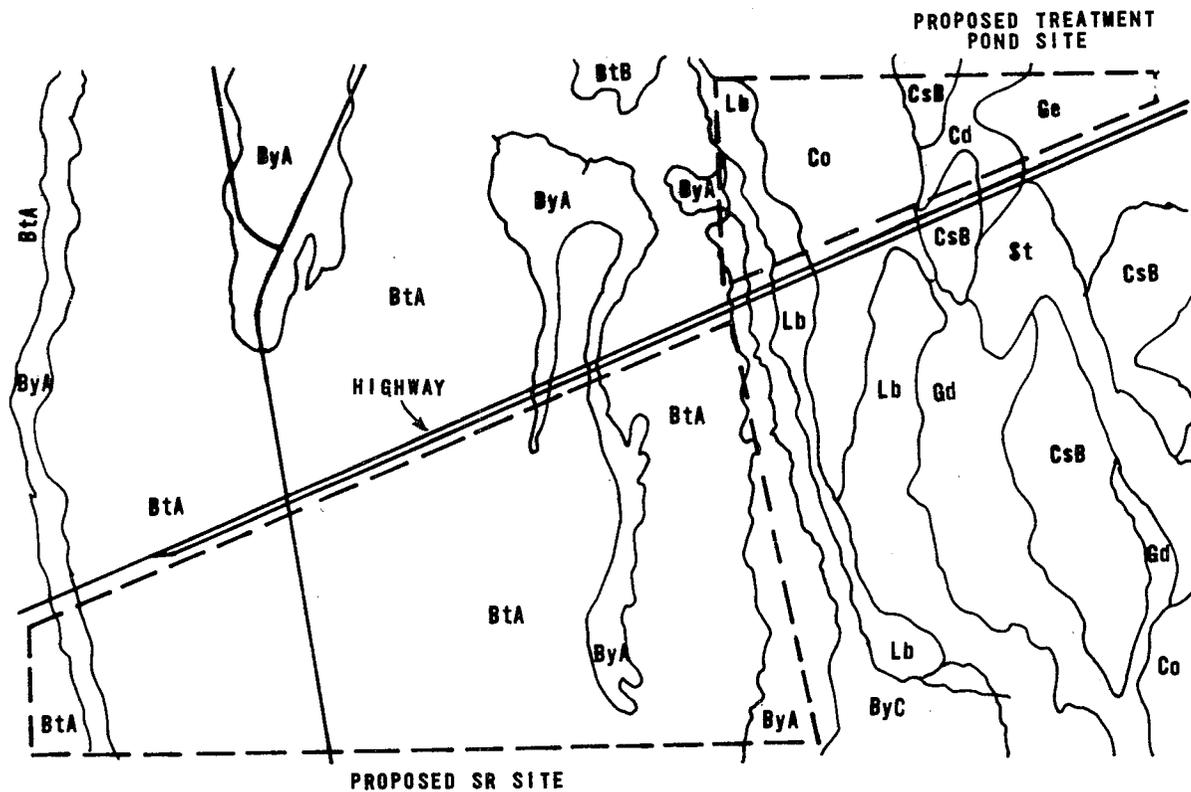

Predominant soil series	Map symbol	Depth to seasonal high water table, m	Depth from surface, cm	Dominant USDA texture	Permeability, cm/h
Bosket	BtA, BtB	>1.5	0-64	Fine sandy loam	5-15
			64-147	Clay loam and sandy clay loam	1.5-5
			147-198	Fine sandy loam and sand	5-15
Broseley	ByA, ByC	>1.5	0-94	Loamy fine -and	15-51
			94-160	Fine sandy loam	5-15
			160-190	Loamy fine sand	15-51
Canalou	Cd	0.6-0.9	0-51	Loamy sand	15-51
			51-122	Sandy loam	15-51
			122-160	Sand	15-51
Cooter	Co	0.6-0.9	0-38	Silty clay	0.15-0.5
			38-152	Loamy sand and sand	15-51
Crevasse	CsB	>1.0	0-25	Loamy sand	15-51
			25-152	Sand	15-51
Gideon	Gd, Ge	0-0.3	0-114	Loam	1.5-5
			114-173	Clay loam	1.5-5
Lilbourn	Lb	0-0.5	0-94	Fine sandy loam	5-15
Sikeston	St	0-0.3	0-30	Sandy clay loam	1.5-5

FIGURE A-1
SOILS MAP

TABLE A-2
CLIMATIC DATA FOR THE WORST YEAR IN 5

Month	Temperature °C		Days with mean temperature, ≤-4 °C	Total precipitation, cm
	Mean	Mean daily, minimum		
Jan	-0.7	-6.6	20	10.1
Feb	-0.9	-8.1	15	10.4
Mar	1.3	-5.6	12	15.1
Apr	12.7	4.6	0	15.8
May	16.7	8.3	0	17.4
Jun	21.1	13.9	0	14.2
Jul	24.1	16.7	0	14.0
Aug	24.4	15.9	0	12.2
Sep	19.8	9.6	0	14.7
Oct	11.9	0.2	4	9.9
Nov	4.6	-3.1	12	14.8
Dec	-0.1	-6.6	<u>17</u>	<u>13.0</u>
Annual			80	162

A.3 Slow Rate System Selection

The selection of the type of land treatment process is dictated by site conditions, climate, and regulatory requirements. In the case of City A, the prohibition of surface discharge eliminated overland flow from consideration. The limit of 10 mg/L nitrate in the ground water, coupled with the high ground water table, eliminated rapid infiltration as an alternative. The SR process appeared feasible based on land availability, soil permeability, and climate.

A.3.1 Preapplication Treatment

The existing treatment facilities cannot be used for pre-application treatment without extensive rehabilitation. Consequently, treatment prior to land application is to be provided by a series of treatment/storage ponds. The primary cell is designed according to state standards: BOD loading equals 38.1 kg/ha·d (34 lb/acre·d) with an operating depth of 1.0 m. The secondary cell is designed for storage.

A.3.2 Crop Selection

As discussed in Section 4.3, the crop selected for the SR process depends on whether the objective is crop production for revenue or minimization of land area by maximizing hydraulic loading rates. For City A, the objective is to minimize land area. Based on the selection criteria in Chapter 4 and conversations with the local farm advisor, City A chose to evaluate water tolerant forage grasses and deciduous forest as two possible crops in an SR system. The proposed site shown in Figure A-1 would be used for either crop.

A.4 System Design

A.4.1 Forage Crop Alternative

Minimizing land area requires the use of the maximum allowable hydraulic loading rate which is governed either by soil permeability or nitrogen loading. Once the hydraulic loading rate is determined, field area and storage requirement are obtained.

A.4.1.1 Hydraulic Loading Based on Soil Permeability

The general water balance equation is used to determine the allowable hydraulic loading based on soil permeability (Section 4.5.1) and is shown as:

$$L_w = ET - Pr + P_w \quad (4-3)$$

where L_w = wastewater hydraulic loading rate, cm/unit time

ET = evapotranspiration rate, cm/unit time

Pr = precipitation rate, cm/unit time

P_w = percolation rate, cm/unit time

The computation is performed on a monthly basis in the form of a water balance table shown in Table A-3. The procedure follows that presented in Section 4.5.1 and is outlined below:

1. Design precipitation for each month is based on a 5-year return period and is obtained from climatic data (Table A-2). The frequency analysis is performed according to standard procedures available

in most hydrology texts or reference books. The precipitation values are entered in Column (1).

2. Estimated monthly evapotranspiration (ET) values for the forage grass are obtained from the local Cooperative Extension Service and are entered in Column (2).
3. The net ET for each month is determined by subtraction of Column (1) from Column (2).
4. The maximum design percolation rate is based on 4% of the minimum permeability in the soil profile-- 1.5 cm/h (0.6 in./h). A value of 4% is used because it is necessary to be conservative for preliminary design. Further optimization will be possible during final design. The limiting permeability is 1.5 cm/h in the clay loam layer at 64 cm (25 in.) in the Bosket soils (Figure A-1). The maximum daily percolation rate is computed as follows:

$$\begin{aligned} P_w \text{ (daily)} &= 0.04 (1.5 \text{ cm/h})(24 \text{ h/d}) \\ &= 1.44 \text{ cm/d} \end{aligned}$$

The monthly rate is then determined by multiplying the daily rate by the number of operating days during the month. Some months may have non-operating days due to farming operations or cold weather.

Green chop harvesting is planned for this system such that downtime for harvesting will not be necessary. Operation will stop on days when the mean temperature is less than -4°C (25°F). Based on the climatic data in Table A-2, nonoperating days due to cold weather are expected during the months of October through March.

For example, in January, the design percolation rate is:

$$\text{Operating days} = 31 - 20 = 11 \text{ d}$$

$$\begin{aligned} P_w \text{ (Jan)} &= (1.44 \text{ cm/d})(11 \text{ d/mo}) \\ &= 15.8 \text{ cm/mo} \end{aligned}$$

The design percolation rate for each month is entered in Column (4).

5. The allowable hydraulic loading rate for each month is computed by adding Column (3) and Column (4). The annual hydraulic loading rate is computed by summing the monthly rates and equals 326 cm (128 in.).

TABLE A-3
HYDRAULIC LOADING RATES BASED ON SOIL
PERMEABILITY: FORAGE CROP ALTERNATIVE
cm

Month	(1) Precipitation Pr	(2) Evapo- transpiration ET	(3) ET - Pr (2) - (1)	(4) Percolation P _w	(5) Hydraulic Loading L _{w(P)} (3) + (4)
Jan	10.1	0.3	-9.8	15.8	6.0
Feb	10.4	0.7	-9.7	18.7	9.0
Mar	15.1	2.1	-13.0	27.4	14.4
Apr	15.8	5.6	-10.2	43.2	33.0
May	17.4	9.7	-7.7	44.6	36.9
Jun	14.3	13.4	-0.9	43.2	42.3
Jul	14.1	15.7	1.6	44.6	46.2
Aug	12.3	13.9	1.6	44.6	46.2
Sep	14.7	8.9	-5.8	43.2	37.4
Oct	9.9	5.0	-4.9	38.9	34.0
Nov	14.8	1.8	-13.0	25.9	12.9
Dec	<u>13.0</u>	<u>0.6</u>	<u>-12.4</u>	<u>20.2</u>	<u>7.8</u>
Annual	162	78	-84	410	326

A.4.1.2 Hydraulic Loading Based on Nitrogen Loading

The annual hydraulic loading rate based on nitrogen is determined by using equation 4-4, shown below:

$$L_w(n) = \frac{(C_p)(Pr - ET) + (U)(10)}{(1 - f)(C_n) - C_p} \quad (4-4)$$

where $L_w(n)$ = allowable annual hydraulic loading rate based on nitrogen limits, cm

- C_p = percolate nitrogen concentration, mg/L
 Pr = design precipitation, cm/yr
 ET = evapotranspiration rate, cm/yr
 U = crop nitrogen uptake, kg/ha·yr
 f = fraction of applied nitrogen removed by volatilization, denitrification, and storage
 C_n = applied wastewater nitrogen concentration, mg/L

The computation was performed using annual rates according to the procedure presented in Section 4.5.2 and is outlined as follows:

1. Determine parameter values for Equation 4-4.
 - a. Crop uptake (U)

$U = 224 \text{ kg/ha}\cdot\text{yr}$ (from Table 4-11)
 - b. Volatilization + denitrification + storage ($V + D + S$)

$f = 0.2$ (estimated, Section 4.2.2)
 - c. Applied nitrogen concentration (C_n)

Compute reduction in nitrogen concentration during storage based on a 53 day storage period which is the minimum detention time in the treatment/storage ponds (Table A-7).

$$C_n = (38 \text{ mg/L})e^{-0.0075(53)}$$

$$= 26 \text{ mg/L}$$
 - d. Percolate nitrogen concentration (C_p)

$C_p = 10 \text{ mg/L}$ (required)
2. Solve Equation 4-4.

$$\begin{aligned}
 L_w(n) &= \frac{10(84) + 224(10)}{(1 - 0.2)(26) - 10} \\
 &= 285 \text{ cm/yr (112 in./yr)}
 \end{aligned}$$

A.4.1.3 Design Hydraulic Loading Rate

As shown in Sections A.4.1.1 and A.4.1.2, the allowable annual hydraulic loading rate based on soil permeability is 326 cm (128 in.) and the rate based on nitrogen limits is 285 cm (112 in.). Since nitrogen loading limits the hydraulic loading rate in this example, the allowable hydraulic loading rate is determined by comparing monthly $L_{w(p)}$ and $L_{w(n)}$.

Monthly hydraulic loading rates based on nitrogen limits are determined using Equation 4-4 with monthly values for Pr and ET obtained from Table A-3. Sufficient data on nitrogen uptake versus time for forage crops were not available, requiring monthly values for U to be estimated from the ratio of monthly ET to the total growing season ET multiplied by the annual crop uptake value (Table A-4, Column 2).

TABLE A-4
DESIGN HYDRAULIC LOADING RATE

Month	(1) Pr-ET, cm	(2) U, kg/ha	(3) $L_{w(n)}$, cm	(4) $L_{w(p)}$, cm	(5) Design L_w , cm
Jan	9.8	0.9	9.9	6.0	6.0
Feb	9.7	2.0	10.8	9.0	9.0
Mar	13.0	6.1	17.7	14.4	14.4
Apr	10.2	16.1	24.4	33.0	24.4
May	7.7	28.0	33.0	36.9	33.0
Jun	0.9	38.5	36.5	42.3	36.5
Jul	-1.6	45.3	40.5	46.2	40.5
Aug	-1.6	40.1	35.6	46.2	35.6
Sep	5.8	25.7	29.2	37.4	29.2
Oct	4.9	14.4	17.9	34.0	17.9
Nov	13.0	5.2	16.9	12.9	12.9
Dec	12.4	1.7	13.1	7.8	<u>7.8</u>
Annual					267

The monthly values of $L_{W(n)}$ and $L_{W(p)}$ are compared with the lower value used for the monthly design hydraulic rate (Table A-4, Column 5). Summing the design monthly hydraulic loading rate gives the design annual hydraulic loading rate, 267 cm (105 in.).

A.4.1.4 Field Area Requirements

The design annual hydraulic loading rate is used to determine the field area requirement:

$$A_w = \frac{Q(365) + \Delta V_s}{10^4 (L_w)} \quad (4-6)$$

where A_w = field area, ha

Q = average daily flow, m^3/d

ΔV_s = net gain or loss in stored wastewater volume due to precipitation, evaporation, and seepage at storage pond, m^3/yr

L_w = design annual hydraulic loading rate, m/yr

For the first calculation of field area, ΔV_s is assumed zero (see Section A.4.1.6) and the field area is calculated as:

$$A_w = \frac{7,570 \text{ m}^3/d (365 \text{ d/yr})}{(10^4 \text{ m}^2/\text{ha})(2.67 \text{ m/yr})} = 103.4 \text{ ha}$$

A.4.1.5 Storage Requirements

Storage of wastewater is required for periods when available wastewater exceeds design hydraulic loading rate. A water balance computation is used to estimate the storage requirement. The procedure is outlined as follows:

1. Enter the design monthly loading rates from Table A-4 (Column 5) into Table A-5, Column 1.
2. Determine available wastewater for each month.

$$W_a = \frac{Q(D)(0.01)}{A_w}$$

where W_a = monthly available wastewater, cm/mo

Q = average daily flow, m^3/d

D = days per month

A_w = field area, ha

The average daily flow is assumed constant. For example the monthly wastewater available for June is:

$$W_{a \text{ June}} = \frac{(7,570 \text{ m}^3/d)(30 \text{ d/mo})(0.01)}{103.4 \text{ ha}}$$
$$= 22.0 \text{ cm/mo}$$

The monthly values of available wastewater are entered in Column (2) of Table A-5.

TABLE A-5
STORAGE VOLUME DETERMINATION:
FORAGE CROP ALTERNATIVE
CM

Month	(1) Hydraulic loading, L_w	(2) Wastewater available, W_a	(3) Change in storage, (2)-(1)	(4) Cumulative storage, S_c
Sep	29.2	22.0	-7.2	0.2 ^a
Oct	17.9	22.7	4.8	4.8
Nov	12.9	22.0	9.1	13.9
Dec	7.8	22.7	14.9	28.8
Jan	6.0	22.7	16.7	45.5
Feb	9.0	20.5	11.5	57.0
Mar	14.4	22.7	8.3	65.3
Apr	24.4	22.0	-2.4	62.9
May	33.0	22.7	-10.3	52.6
Jun	36.5	22.0	-14.5	38.1
Jul	40.5	22.7	-17.8	20.3
Aug	35.6	22.7	-12.9	7.4

a. Rounding error, assume zero.

3. Compute the change in storage each month by subtracting hydraulic loading [Column (1)] from available wastewater [Column (2)]. Enter the results in Column (3).
4. Compute the cumulative change in storage in the end of each month by adding the change in storage in Column (3) to the accumulated quantity from the previous month in Column (4).
5. Compute the required total storage volume using the maximum cumulative storage in Column (4) and the estimated field area:

$$\begin{aligned}
 V_s &= S_c A_w \\
 &= (65.3 \text{ cm})(103.4 \text{ ha})(10^2 \text{ m}^3/\text{cm}\cdot\text{ha}) \\
 &= 675,200 \text{ m}^3
 \end{aligned}$$

A.4.1.6 Final Storage and Pond Design

The facultative pond for preapplication treatment serves as the storage reservoir. A two-cell pond system is selected with the design criteria of the primary cell based on the state's BOD loading criteria of 38.1 kg BOD/ha·d (34 lb/acre·d) and an operating depth of 1.0 m.

$$\begin{aligned}
 A_p &= \text{area (primary)} \\
 &= \frac{(7570 \text{ m}^3/\text{d})(200 \text{ mg/L})(10^{-6} \text{ kg/mg})(10^3 \text{ L/m}^3)}{38.1 \text{ kg/ha}\cdot\text{d}} \\
 &= 39.7 \text{ use } 40 \text{ ha} \\
 V_p &= \text{volume (primary)} \\
 &= (40 \text{ ha})(10^4 \text{ m}^2/\text{ha})(1.0 \text{ m}) \\
 &= 400,000 \text{ m}^3
 \end{aligned}$$

The storage volume in the second cell is the difference between the required total storage and the volume of the primary cell.

$$\begin{aligned}
 V_{\text{sec}} &= V_s - V_p \\
 &= 675,200 - 400,000 \\
 &= 275,200 \text{ m}^3
 \end{aligned}$$

The actual volume of the secondary pond will change due to evaporation, precipitation and seepage in the two cell pond

area. To obtain the final storage volume the following steps are used.

1. Calculate the storage area of the second cell using a volume of 275,200 m³ and an operating depth of 1.5 m.

$$\begin{aligned}
 A_{\text{sec}} &= \frac{V_{\text{sec}}}{d_s} && (4-8) \\
 &= \frac{275,200}{1.5} \\
 &= 183,500 \text{ m}^2 \quad \text{use 18 ha}
 \end{aligned}$$

2. Determine the monthly net gain or loss in storage volume due to precipitation, evaporation, and seepage (Table A-6, Column 3). Annual lake evaporation equals 89 cm (33 in.) and is distributed monthly in the same ratios of monthly ET to annual ET. A maximum seepage rate of 0.15 cm/d is allowed by state standard. As an example, the net gain or loss for July is:

$$\begin{aligned}
 \Delta V_{s\text{July}} &= (\text{Precipitation} - \text{evaporation} - \text{seepage}) \\
 &\quad \times (\text{surface area}) \\
 &= (14.1 - 18.0 - 4.6)(58 \text{ ha}) \\
 &\quad \times [(10^2 \text{ m/cm})(10^4 \text{ m}^2/\text{ha})] \\
 &= -49,300 \text{ m}^3
 \end{aligned}$$

3. Tabulate the volume of wastewater available each month, Q_m. In this example, the daily flow is assumed constant and monthly flows vary according to the number of days per month (Table A-6, Column 4).

$$\begin{aligned}
 Q_{m\text{July}} &= (7,570 \text{ m}^3/\text{d})(31 \text{ d}) \\
 &= 234.7 \times 10^3 \text{ m}^3/\text{mo}
 \end{aligned}$$

4. Determine the adjusted field area accounting for the net gain from storage.

$$A_w' = \frac{\Sigma \Delta V_s + \Sigma Q_m}{(L_w)(10^4 \text{ m}^2/\text{ha})} \quad (4-10)$$

$$A_w' = \frac{(108.0 + 2,763.3)(10^3 \text{ m}^3)}{2.67 \text{ m} (10^4)}$$

$$= 107.5 \text{ ha} (266 \text{ acres})$$

TABLE A-6
FINAL DETERMINATION OF STORAGE VOLUME

Month	(1) Evaporation, cm	(2) Seepage, cm	(3) Net gain/loss ΔV_s $\text{m}^3 \times 10^3$	(4) Available wastewater Q_m $\text{m}^3 \times 10^3$	(5) Applied wastewater V_w $\text{m}^3 \times 10^3$	(6) Change in storage ^b $\text{m}^3 \times 10^3$	(7) Cumulative storage S_c $\text{m}^3 \times 10^3$
Sep	10.2	4.5	0	227.1	313.9	-86.8	85.7
Oct	5.7	4.6	-2.3	234.7	192.4	40.0	-1.1 ^a
Nov	2.1	4.5	47.6	227.1	138.7	136.0	40.0
Dec	0.7	4.6	44.7	234.7	83.8	195.6	176.0
Jan	0.3	4.6	30.2	234.7	64.5	200.4	371.6
Feb	0.8	4.2	31.3	212.0	96.8	146.5	572.0
Mar	2.4	4.6	47.0	234.7	154.8	126.9	718.5
Apr	6.4	4.5	28.4	227.1	262.3	-6.8	845.4 ^b
May	11.1	4.6	9.9	234.7	354.7	-110.0	838.6
Jun	15.3	4.5	-31.9	227.1	392.4	-197.2	728.5
Jul	18.0	4.6	-49.3	234.7	435.4	-250.0	531.3
Aug	15.9	4.6	-47.6	234.7	382.7	-195.6	281.3
Annual			108.0	2,763.3	2,872.4		

a. Rounding error, assume zero.

b. Design storage volume

5. Calculate the monthly volume of applied wastewater (Table A-6, Column 5) using the design monthly hydraulic loading rate and adjusted field area. For example:

$$\begin{aligned}
 V_{w\text{July}} &= (L_{w\text{July}}) (A_w') (10^4 \text{ m}^2/\text{ha}) (10^{-2} \text{ m/cm}) \quad (4-11) \\
 &= (40.5 \text{ cm})(107.5 \text{ ha})(10^2) \\
 &= 435.4 \times 10^3 \text{ m}^3
 \end{aligned}$$

6. Determine the net change in storage each month (Table A-6, Column 6) based on monthly applied wastewater, V_w , available wastewater, Q_m , and net storage gain/loss, ΔV_s .

$$\text{Change in storage} = Q_m + \Delta V_s - V_w$$

7. Calculate the cumulative storage volume for the end of each month (Column 7) to determine the maximum design storage volume.

$$V_s = 845,400 \text{ m}^3$$

8. Adjust the depth of the second cell to accommodate the increased storage volume.

$$V_{\text{sec}} = 845,400 - 400,000 = 445,400$$

$$d_s = \frac{V_{\text{sec}}}{A_{\text{sec}}} = \frac{445,400 \text{ m}^3}{180,000 \text{ m}^2} \quad (4-12)$$

$$= 2.47 \text{ m, use 2.5 m.}$$

The depth of ground water prevents lowering the depth of the pond more than 1.5 m (5 ft) below the ground surface. Consequently, most of the storage pond volume will be above ground surface and require embankments. The design criteria for the storage lagoons are shown in Table A-7.

TABLE A-7
DESIGN CRITERIA FOR STORAGE LAGOONS:
FORAGE CROP ALTERNATIVE

Primary cell	
Surface area, ha	40.0
Total depth, m	1.5
Operating depth, m	1.0
Total storage, d	79
Storage above 0.5 m, d	53
Secondary cell	
Surface area, ha	18.0
Total depth, m	3.0
Operating depth, m	2.5
Total storage at 2.5 m, d	59
Total storage at operating depth	
Days	112
m ³	850,000

A.4.1.7 Distribution and Application

When selecting the type of distribution system, the designer must consider the terrain, crop, soils, and capital and operation/maintenance costs. Based on a cost comparison not included in the example, the designer recommended a center pivot irrigation system as the most cost-effective system for the forage crop alternative.

The design of the distribution system is based on the maximum hydraulic loading rate per application. In this case, the maximum monthly loading equals 40.5 cm (15.9 in.) in July. An application frequency of four times per month is selected to allow adequate drying between applications (see Appendix E for guidelines on making this determination). The hydraulic loading rate per application then equals 10.1 cm (4.0 in.).

In consultation with manufacturers of center pivot equipment, it was determined that two center pivot systems could be used for distribution each irrigating an area of 53.8 ha and using a revolution period of 170 hours. The unit capacity is then determined as follows (Section E.2.6):

$$\begin{aligned} Q &= CAD/t \\ &= \frac{28.1 (53.8)(10.1)}{170} \\ &= 89.8 \text{ L/s} \end{aligned}$$

where Q = discharge capacity, L/s (gal/min)

C = constant, 28.1 (453)

A = field area for one center pivot, ha (acre)

D = hydraulic loading/application depth, cm (in.)

t = number of operating hours per application

Using the unit capacity, the design of the center pivot system is completed. In order to determine the nozzle and pipeline size, the design must consider headlosses in the line and the pressure required to ensure proper operation of the nozzles.

Unit capacity also is used to develop design criteria for the pumps. Pumps are required to deliver wastewater to the site and at a pressure sufficient to allow proper

distribution of the wastewater. Assuming the two pivots operate simultaneously, the pumps are sized for a total flow of 179.6 L/s. The designer chose four pumps and one standby rated at 45 L/s. The force main is sized using a maximum velocity of 1.7 m/s and the following formula:

$$A = Q_t/V$$

where A = area of pipe

Q_t = total flow

V = maximum velocity

For circular pipes:

$$D = \sqrt{\frac{4Q}{\pi V}}$$

where D = pipe diameter

Applying the equation gives:

$$D = \sqrt{\frac{(180. \text{L/s})(10^{-3} \text{ m}^3/\text{L})}{1.7 \text{ m/s}} \frac{(4)}{\pi}} = 0.37 \text{ m, use } 0.38 \text{ m}$$

A final consideration in the design of the center pivot system is the disruption of the tracking system due to wet soil conditions. Because of the pivot rotational speed, the application rate at the unit capacity equals 1.0 cm/h during the 9 to 10 h period it takes to pass a given point. Although this rate is less than the permeability or basic infiltration rate of the surface soil, precautions need to be taken. These precautions include preparing the tracking route by either soil compaction or gravel installation.

A summary of design data for the treatment site is given in Table A-8. Figure A-2 shows the pond and distribution system layout.

A.4.1.8 Cost Estimates

Cost estimates of the forage crop irrigation system are determined from EPA publication "Cost of Land Treatment Systems" EPA-430/9-75-003, using the criteria shown in Table A-9. Cost estimate calculations and total costs are presented in Tables A-10 and A-11, respectively.

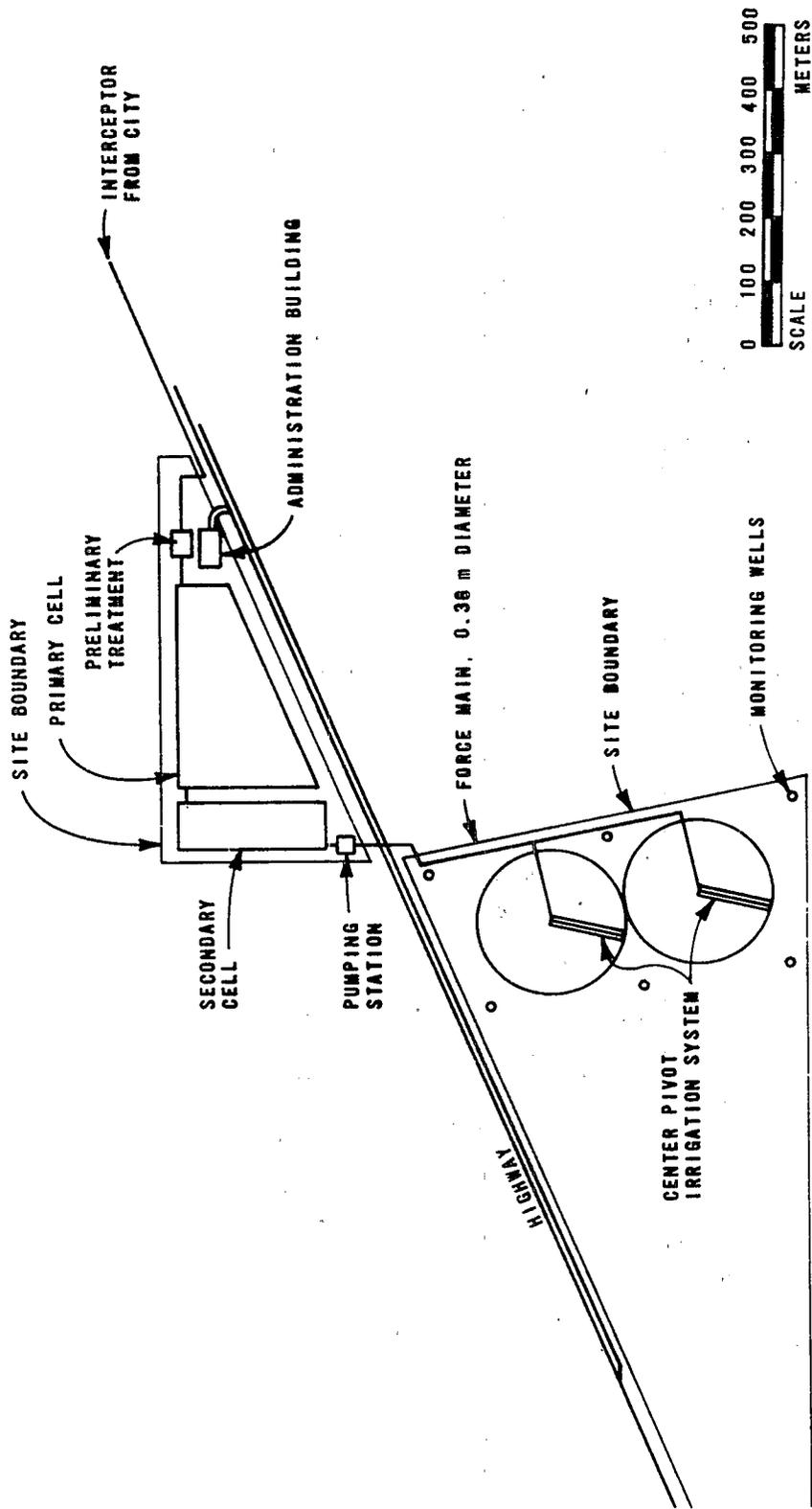

FIGURE A-2
SYSTEM LAYOUT: FORAGE CROP ALTERNATIVE

TABLE A-8
SLOW RATE SYSTEM DESIGN DATA:
FORAGE CROP ALTERNATIVE

Irrigation system	
Annual hydraulic loading rate, cm	267
Field area, ha	107.5
Buffer, m	15
Application frequency, No./mo	4
Maximum hydraulic loading per application, cm	10.1
Application equipment, No. of center pivots	2
Lateral length, m	408
Operating pressure, N/cm ²	34.5
Field dimensions with buffer zone, m x m	1,662 x 846
Total area, ha	140.6
Pumping station	
Duty pumps, No. at m ³ /min	4 at 2.7
Standby pumps, No. at m ³ /min	1 at 2.7
Pumping time (peak flow)	
h/d	24
d/wk	7
h/wk	168
Force main	
Velocity, m/s	
Average	1.1
Maximum	1.7
Pipe diameter, m	0.38
Maximum headloss, m/1,000 m	6

TABLE A-9
COST ESTIMATE CRITERIA:
FORAGE CROP ALTERNATIVE^a

Circulation date	October 1980
Sewage treatment plant index update, 370.1/177.5	2.085
Sewer index update, 397.2/194.2	2.045
Operation and maintenance update, 2.13/1.00	2.13
Construction cost locality factor	1.0
Operation and maintenance/labor cost factor	1.0
Power cost locality factor	1.0
Interest rate, i	7.125%
Interest period, n	20
Present worth factor, PWF	0.2525
Capital recovery factor, CRF	0.0953

a. Based on "Cost of Land Treatment Systems,"
EPA-430/9-75-003.

TABLE A-10
COST ESTIMATE CALCULATIONS:
FORAGE CROP ALTERNATIVE

1. Preliminary treatment		
Capital (\$48,000 x 2.085)		\$100,100
Operation and maintenance (\$9,400 x 2.13)		20,000
2. Treatment		
Capital		
Primary cell (\$150,000 x 1.7 x 2.085)		\$531,700
Asphalt liner (\$352,000 x 2.085)		733,900
Operation and maintenance (\$10,000 x 2.13)		21,300
3. Pumping to application site		
Peak flow = 180 L/s		
Avg flow = 135 L/s		
Capital (\$210,000 x 2.085 x 0.80)		\$350,300
Operation and maintenance (\$26,100 x 2.13)		55,600
4. Force main (2.6 km: 0.38 m)		
Capital (\$162,100 x 2.045)		\$331,500
Operation and maintenance (\$400 x 2.13)		900
5. Storage (D = 59d, depth = 3.0 m)		
Capital (\$447,000 x 2.045)		\$914,100
Operation and maintenance (\$2,400 x 2.13)		5,100
6. Field preparation		
Pond area (58 ha x 1.25 = 72.5 ha, brushes and trees)		
Capital (\$80,000 x 2.045)		\$163,600
Application site (53.8 ha x 2 = 107.6 ha, pasture)		
Capital (\$1,700 x 2.045)		3,500
7. Distribution, center pivots (107.6 ha)		
Capital (\$135,000 x 2.045)		\$276,100
Operation and maintenance (\$18,400 x 2.13)		39,200
8. Administrative and laboratory		
Capital (\$64,000 x 2.045)		\$130,900
Operation and maintenance (\$10,200 x 2.13)		21,700
9. Monitoring wells (six wells at 12 m depth)		
Capital (\$4,800 x 2.045)		\$ 9,800
Operation and maintenance (\$600 x 2.13)		1,300
10. Roads and fences (application site, 140.6 ha)		
Capital (\$102,000 x 2.045)		\$208,600
Operation and maintenance (\$2,700 x 2.13)		5,800
11. Planting and harvesting		
Operation and maintenance		
Variable costs (\$319/ha x 107.5 ha)		\$ 34,300
Fixed costs (\$247/ha x 107.5 ha)		26,600
12. Annual crop revenue		
107.5 ha x 15.6 tons/ha x \$42/ton		\$ 70,400
13. Land costs		
Pond area (72.5 ha x \$2,000/ha)		\$145,000
Application area (140.6 ha x \$3,700/ha)		520,200

TABLE A-11
SUMMARY OF COSTS: FORAGE CROP ALTERNATIVE

Component	Capital	Salvage ^a	Operation and maintenance
Preliminary treatment	\$ 100,100	\$ 20,000	\$ 20,000
Treatment/storage ponds	2,179,700	1,089,800	26,400
Pumping	350,300	42,000	55,600
Force main	331,500	165,800	900
Site clearing	167,100	0	0
Distribution	276,100	0	39,200
Administration building	130,900	26,200	21,700
Monitoring	9,800	0	1,300
Roads and fences	208,600	68,200	5,800
Planting and harvesting	--	--	60,900
Crop revenue	--	--	<u>-70,400</u>
Total construction	<u>\$3,754,100</u>	<u>\$1,412,000</u>	<u>\$ 161,400</u>
Engineering, contingencies, overhead, etc.	938,500	0	0
Land	<u>665,200</u>	<u>1,201,400</u>	<u>0</u>
Total project	<u>\$5,357,800</u>	<u>\$2,613,400</u>	<u>\$ 161,400</u>
Present worth	<u> </u>	<u>-659,000</u>	<u>1,693,600</u>
Total present worth	<u>\$6,392,400</u>		
Equivalent annual cost ^b	<u>\$ 609,200</u>		

a. Salvage values are determined by straight line depreciation over the useful life of the components, e.g., useful life of ponds N = 40 yr; planning period P = 20 yr; salvage value $F = (1 - P/N) (\text{initial cost}) = 0.5(2,179,700) = 1,089,800$.

b. Equivalent annual cost = present worth x 0.0953.

A.4.2 Deciduous Forest Crop Alternative

As in the forage crop design, the selection of the maximum allowable hydraulic loading for the forest crop alternative minimizes the required land area. In the City A region, deciduous trees, in particular poplar, grow well. The poplar is a fast-growing tree and a pulp wood market exists.

A.4.2.1 Hydraulic Loading Based on Soil Permeability

The monthly water balance calculations are determined as in the forage crop water balance. The growing season for the deciduous tree selected lasts 214 days based on an average mean temperature of 10 °C (50 °F). Evaporation from the forest during the growing season is assumed to equal that from a full cover pastureland. No evaporation is assumed for the nongrowing season; wastewater applied during this time is limited by precipitation and percolation. Because the site is the same for both forage and forest alternative, the design percolation rate is the same. Applying these assumptions to the water balance Equation 4-3 results in a maximum hydraulic loading of 321 cm (126 in.) and a maximum monthly loading of 46.2 cm (18.2 in.).

A.4.2.2 Hydraulic Loading Based on Nitrogen Loading

Equation 4-4 is used to determine the hydraulic loadings based on nitrogen loading as in the forage crop alternative (Section A.4.1.2). No crop growth or nitrogen uptake was assumed for the months of December through March. Using a whole-tree harvest approach, the total annual nitrogen uptake is assumed to equal 200 kg/ha (178 lb/acre) (see Section 4.3.2.1). Based on these assumptions, the annual hydraulic loading equals 268 cm (105.5 in.).

A.4.2.3 Design Hydraulic Loading Rate

As in the forage crop alternative, nitrogen loading limits the hydraulic loading rate. Design monthly hydraulic loading rates are determined by comparing the monthly hydraulic loading rates based on soil permeability and nitrogen loading and using the lower value. Based on this comparison the design annual hydraulic loading rate is 254 cm (100 in.).

A.4.2.4 Field Area Requirements

Applying Equation 4-6 and assuming the net gain/loss from storage, ΔV_s , is zero, the initial field area is:

$$A_w = \frac{(7,570 \text{ m}^3/\text{d})(365 \text{ d/yr})}{(10^4 \text{ m}^2/\text{ha})(2.54 \text{ m})} = 108.8 \text{ ha}$$

A.4.2.5 Storage Requirements

As in the case with forage, storage of wastewater during nonoperating time depends on monthly hydraulic loadings and available wastewater. Applying the water balance Equation 4-3 and following steps 1-4 of Section A.4.1.5 results in Table A-12. The net storage volume required for year-round application is shown below:

$$V_{st} = (64.6 \text{ cm})(108.8 \text{ ha})(10^2) = 702,800 \text{ m}^3$$

TABLE A-12
INITIAL DETERMINATION OF STORAGE VOLUME:
FOREST CROP ALTERNATIVE
CM

Month	P	ET	ET-P	P _w	L _w (P)	L _w (n)	L _w	Available wastewater W _a	Change in storage	Cumulative storage S _c
Oct	9.9	5.0	-4.9	38.9	34.0	17.3	17.3	21.5	4.2	0.2 ^a
Nov	14.8	0	-14.8	25.9	11.1	13.7	11.1	20.9	9.8	4.2
Dec	13.0	0	-13.0	20.2	7.2	12.0	7.2	21.5	14.3	14.0
Jan	10.1	0	-10.1	15.8	5.7	9.4	5.7	21.5	15.8	28.3
Feb	10.4	0	-10.4	18.7	8.3	9.6	8.3	19.5	11.2	44.1
Mar	15.1	0	-15.1	27.4	12.3	14.0	12.3	21.6	9.3	55.3
Apr	15.8	5.6	-10.2	43.2	33.0	23.8	23.8	20.9	-2.9	64.6
May	17.4	9.7	-7.7	44.6	36.9	32.0	32.0	21.6	-10.4	61.7
Jun	14.2	13.4	-0.9	43.2	42.3	35.1	35.1	20.9	-14.2	51.3
Jul	14.0	15.7	1.6	44.6	46.2	38.7	38.7	21.6	-17.1	37.1
Aug	12.2	13.9	1.6	44.6	46.2	34.1	34.1	21.6	-12.5	20.0
Sep	14.7	8.9	-5.8	43.2	37.4	28.2	28.2	20.9	-7.3	7.5
Annual	162	72	-90	410	321	268	254			

a. Rounding error, assume zero.

A.4.2.6 Final Storage and Pond Design

The steps outlined in Section A.4.1.6 are followed to determine the final storage and pond design. The design of the primary cell remains the same with the secondary cell being used to incorporate the net gain/loss from the pond area due to precipitation, evaporation, and seepage. As before, the initial depth of the secondary cell is assumed at 1.5 m (5 ft) resulting in a storage pond area of 20 ha (50 acres). The adjusted field area is calculated to be 113.2 ha (280 acres). The results of secondary cell design are shown in Table A-13.

TABLE A-13
DESIGN DATA FOR STORAGE POND:
FOREST CROP ALTERNATIVE

Secondary cell	
Surface area, ha	20
Total depth, m	2.9
Operating depth, m	2.4
Storage at operating depth, d	63
Total storage at operating depth	
Days	116
m ³	880,000

A.4.2.7 Distribution and Application

Solid set sprinkler systems, both surface and buried, are the most common methods used in forest crops for distributing wastewater. In the case of City A, the proposed treatment site is under pasture and the subsoils are uniform without much debris, consequently either system would work. The installation cost for the surface system is less than the buried system, but the cost for operation and maintenance is less for the buried system. After comparing total cost and discussing with City A their desire for low operation and maintenance cost, the designer selected the buried solid set sprinkler system.

The design of the sprinkler system is based on the maximum hydraulic load per application. An application frequency of 4 times per month is chosen to allow adequate aeration of the tree root system. Based on a maximum monthly hydraulic loading of 38.7 cm (15.2 in.), the maximum hydraulic loading per application of 9.7 cm (3.8 in.) is obtained. Referring to manufacturers literature for solid set irrigation

systems, design data are obtained and presented in Table A-14. The pond and irrigation system layout is shown in Figure A-3.

TABLE A-14
DESIGN DATA:
FOREST CROP ALTERNATIVE

<u>Irrigation system</u>		
Annual hydraulic loading rate, cm		254
Field area, ha		113
Buffer, m		15
Application frequency, No./mo		4
Total area, ha		123.5
Maximum hydraulic loading per application, cm		9.7
Distribution system		Buried solid set sprinklers
Spacing, m x m		18 x 21
Sprinkler flow, L/s at N/cm ²	0.85 @ 36, 0.63 cm diam	
Lateral length, m		432
Sprinklers per line, No.		24
Application period, h		12
Settings per day, No.		2
Operating time, h/d		24
Laterals per setting, No.		9
Pumping rate, 9 x 24 x 0.85, L/s		184
<u>Pumping station</u>		
Duty pumps, No. at m ³ /min		4 at 2.76
Standby pumps, No. at m ³ /min		1 at 2.76
Pumping time		
h/d		24
d/wk		6
h/wk		144
<u>Force main</u>		
Velocity, m/s		
Average		1.1
Maximum		1.7
Pipe diameter, m		0.38
Maximum headloss, m/1,000 m		6.4

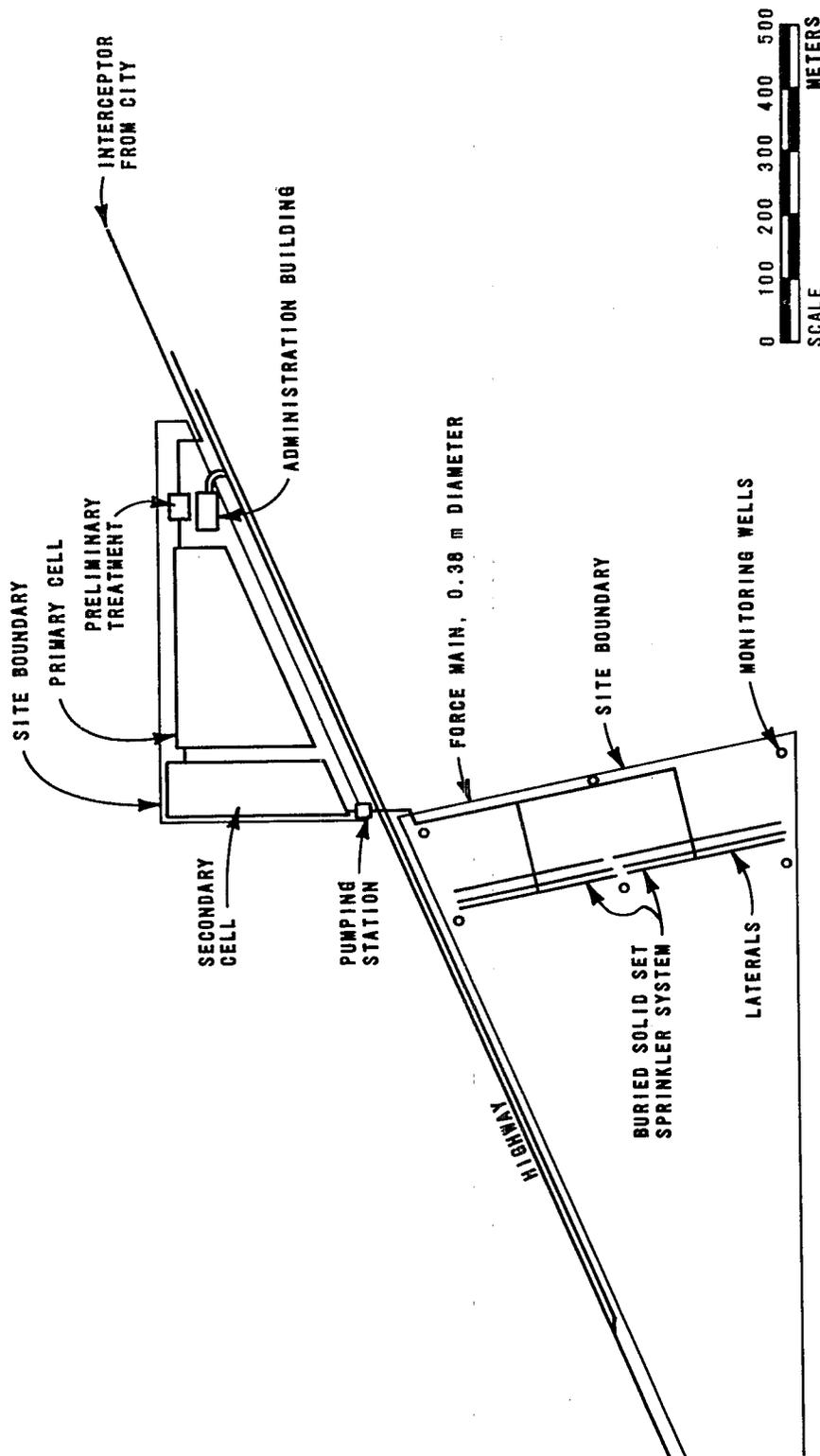

FIGURE A-3
SYSTEM LAYOUT : FOREST CROP ALTERNATIVE

A.4.2.8 Cost Estimates

Cost estimates are determined by the same method used for the forage crop alternative (Table A-9) and are summarized in Table A-15. Crop revenue is based on a harvest of one-fourth of the area every year beginning the fourth year, an annual growth rate of 25 tons/ha, a dry weight of 0.4 ton/cord, and a stumpage price of \$4/cord used for pulpwood.

TABLE A-15
SUMMARY OF COST: DECIDUOUS FORESTS

Component	Capital	Salvage	Operation and maintenance
Preliminary treatment	\$ 100,100	\$ 20,000	\$ 20,000
Treatment/storage ponds	2,206,300	1,103,100	26,800
Pumping	325,300	39,000	55,600
Force main	314,000	157,000	900
Site clearing	167,500	0	0
Distribution	1,295,700	0	54,200
Administration building	130,900	26,200	21,700
Monitoring	9,800	0	1,300
Roads	112,500	75,000	4,900
Planting and harvesting	14,000	--	2,800
Crop revenue	<u>--</u>	<u>--</u>	<u>-28,000</u>
Total construction	\$4,676,100	\$1,420,300	\$ 160,200
Engineering, contingencies, overhead, etc.	1,169,000	--	--
Land	<u>606,900</u>	<u>1,096,100</u>	<u>--</u>
Total project	\$6,452,000	\$2,516,400	\$ 160,200
Present worth	<u>--</u>	<u>-635,400</u>	<u>1,681,000</u>
Total present worth	\$7,497,600		
Annual equivalent cost	\$ 714,500		

A.4.3 Selected SR Design

Comparing annual equivalent costs, the forage crop alternative is the most cost-effective alternative, with an annual equivalent cost of \$609,200/yr, and is selected.

Management of the selected alternative consists of an initial seedbed preparation, seeding, cultivating, irrigating, and harvesting four times per year. Prior to harvesting, the field requires a drying period of 2 to 3 weeks. The harvested forage grass is then chopped and hauled away for use. The harvesting may be handled either by City A personnel or contracted outside. Assuming contract harvesting, the estimated staff requirement for all of the remaining operation is 1.5 man-years per year.

A.4.4 Energy Requirements

The two areas of operation that contribute most to the system energy requirements are pumping and crop production. Assuming 3,900 hours of operating time, 75% overall system efficiency, and 20% headloss through the distribution system, the energy required for pumping is shown below:

$$\text{TDH} = \text{pipe losses} + \text{operating pressure} + \text{losses through distribution system at sprinkler}$$

$$= 2,600 \text{ m} \frac{(5.5 \text{ m})}{1,000 \text{ m}} + 35 + 7$$

$$= 56.3 \text{ m}$$

$$\text{Energy} = \frac{(Q)(\text{TDH})(t)}{(6,123)(E)}$$

$$= 515,200 \text{ kWh/yr}$$

Energy required for forage crop production is computed using the energy requirement factor given in Table 8-1.

$$\text{Energy} = \frac{107.5 \text{ ha} \times (3.63 \text{ MJ/ha})}{3.6 \text{ MJ/kWh}}$$

$$= 110 \text{ kWh/yr}$$

Therefore, the total annual energy budget for this SR example is:

$$110 + 515,200 = 515,310 \text{ kWh/yr}$$

The total energy budget for an activated sludge and anaerobic digestion treatment system of equal size would be 680,000 kWh/yr electrical energy and $3,100 \times 10^6$ BTU/yr fuel energy or a total of 967,000 kWh/yr.

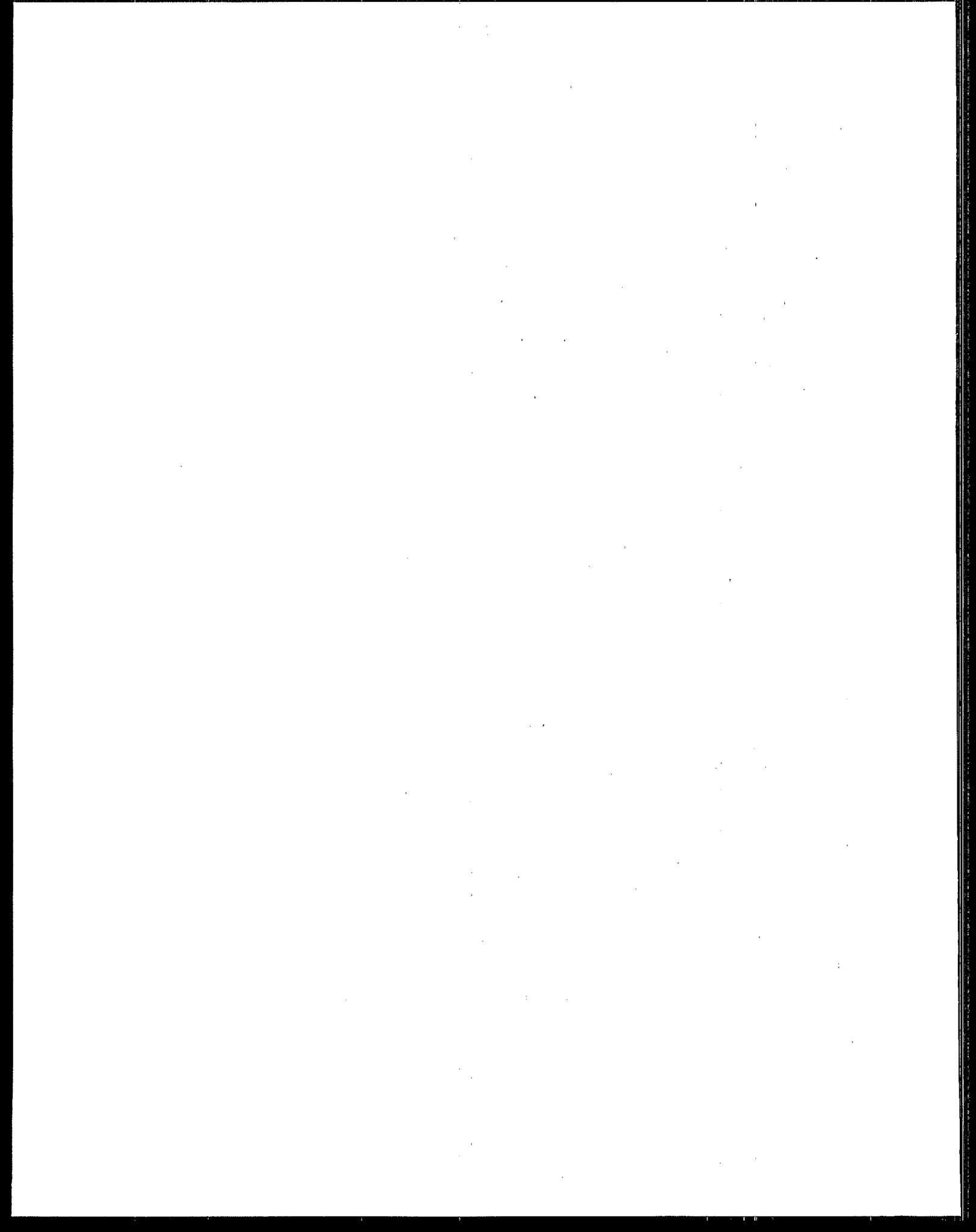

APPENDIX B

RAPID INFILTRATION DESIGN EXAMPLE

B.1 Introduction

The design example described in this appendix is intended to demonstrate only the RI design procedures described in Chapter 5; therefore, components that are common to most wastewater treatment systems, such as transmission systems and pumping stations, are described but not designed in detail. However, a cost estimate and an energy budget are developed for the entire system.

B.2 Design Considerations

B.2.1 Design Community

Community B is located in the southeastern United States on the Coastal Plain. The area in which the community is located is characterized by relatively flat areas lying between numerous creeks and swamps that drain into North Creek. One of these creeks, South Creek, borders the northeast edge of the community. The elevation of Community B is 45.7 m (150 ft); near the community, elevations range from 42.7 to 54.9 m (140 to 180 ft).

B.2.2 Wastewater Quality and Quantity

The design average daily flow is 6,060 m³/d (1.6 Mgal/d) and the design peak flow is 9,090 m³/d (2.4 Mgal/d).

Expected wastewater characteristics under design flow conditions are presented in Table B-1. Wastewater is essentially domestic in character and expected concentrations of trace elements and organics are low.

TABLE B-1
PROJECTED WASTEWATER CHARACTERISTICS

Parameter	Value
BOD ₅ , mg/L	175
Total suspended solids, mg/L	150
Total nitrogen, mg/L	50
Ammonia nitrogen (as N), mg/L	20
Total phosphorus (as P), mg/L	10
pH, units	6.9

B.2.3 Existing Wastewater Treatment Facilities

The existing treatment facilities provide primary treatment, and treated wastewater fails to meet present discharge requirements. The facilities are old and would require significant repairs and additions to produce treated water that would meet all discharge requirements.

B.2.4 Discharge Requirements

Discharge requirements for surface waters are presented in Table B-2. The ammonia nitrogen limit during summer months is intended to prevent ammonia toxicity to fish. The inhibited test for carbonaceous BOD does not measure nitrogenous BOD. The test is often specified for systems that nitrify wastewater, because such systems tend to have higher BOD₅ concentrations although the water quality is equivalent.

TABLE B-2
SURFACE WATER DISCHARGE REQUIREMENTS

Parameter	North Creek	South Creek
BOD ₅ , mg/L (inhibited test for carbonaceous BOD)	30	20
Dissolved oxygen, mg/L	5	5
pH	6-9	6-9
Total suspended solids, mg/L	30	20
Fecal coliforms, MPN/100 mL	200	200
Ammonia nitrogen (as N), mg/L (May-October only)	2	2

B.2.5 Climate

Average temperature and precipitation in Community B were obtained from local climatological data and are shown by month in Table B-3. A rainfall frequency distribution curve, developed from 26 years of recorded data, indicates that the wettest year in 10 yields 137 cm (54 in.) of precipitation in Community B. The average total annual precipitation (rain plus snow) is 111 cm (43.7 in.).

TABLE B-3
AVERAGE METEOROLOGICAL CONDITIONS

Month	Temperature, °C	Precipitation, cm	
		Rain	Snow ^a
Jan	8.6	6.71	0.25
Feb	9.3	8.05	0.51
Mar	12.6	9.24	1.02
Apr	17.5	9.17	0.00
May	22.2	7.34	0.00
Jun	26.0	10.87	0.00
Jul	27.0	15.85	0.00
Aug	26.6	11.61	0.00
Sep	23.8	10.41	0.00
Oct	18.3	5.54	0.00
Nov	12.6	5.87	Trace
Dec	8.4	7.77	0.76
Year	17.8	108.43	2.54

a. Water equivalent.

B.3 Site and Process Selection

Community B contacted landowners within a 4 km (2.5 mile) radius of the existing treatment facilities to determine their interest in leasing or selling their property for land treatment. Five potential sites were identified during Phase 1 of the planning process and screened in accordance with the procedure in Chapter 2. Two of the sites were available for purchase and had soils suitable for RI (Sites 1 and 2 on Figure B-1). One of these two sites (Site 2) and the three remaining sites had enough land to be suitable for SR. None of the soils in the area were suitable for OF (Table B-4). Therefore, OF was eliminated from consideration as a viable alternative.

During Phase 2 of the planning process, field investigations were conducted at each of the five sites. Based on the field investigations, preliminary design criteria and cost estimates were developed. This analysis indicated that the two RI alternatives were more cost effective than any of the SR alternatives and lower in total present worth than the best conventional secondary treatment and discharge alternative. The preliminary analysis also indicated that an RI facility at Site 1 would be slightly less expensive than an RI system at Site 2. For these reasons, the alternative selected by Community B was RI at Site 1.

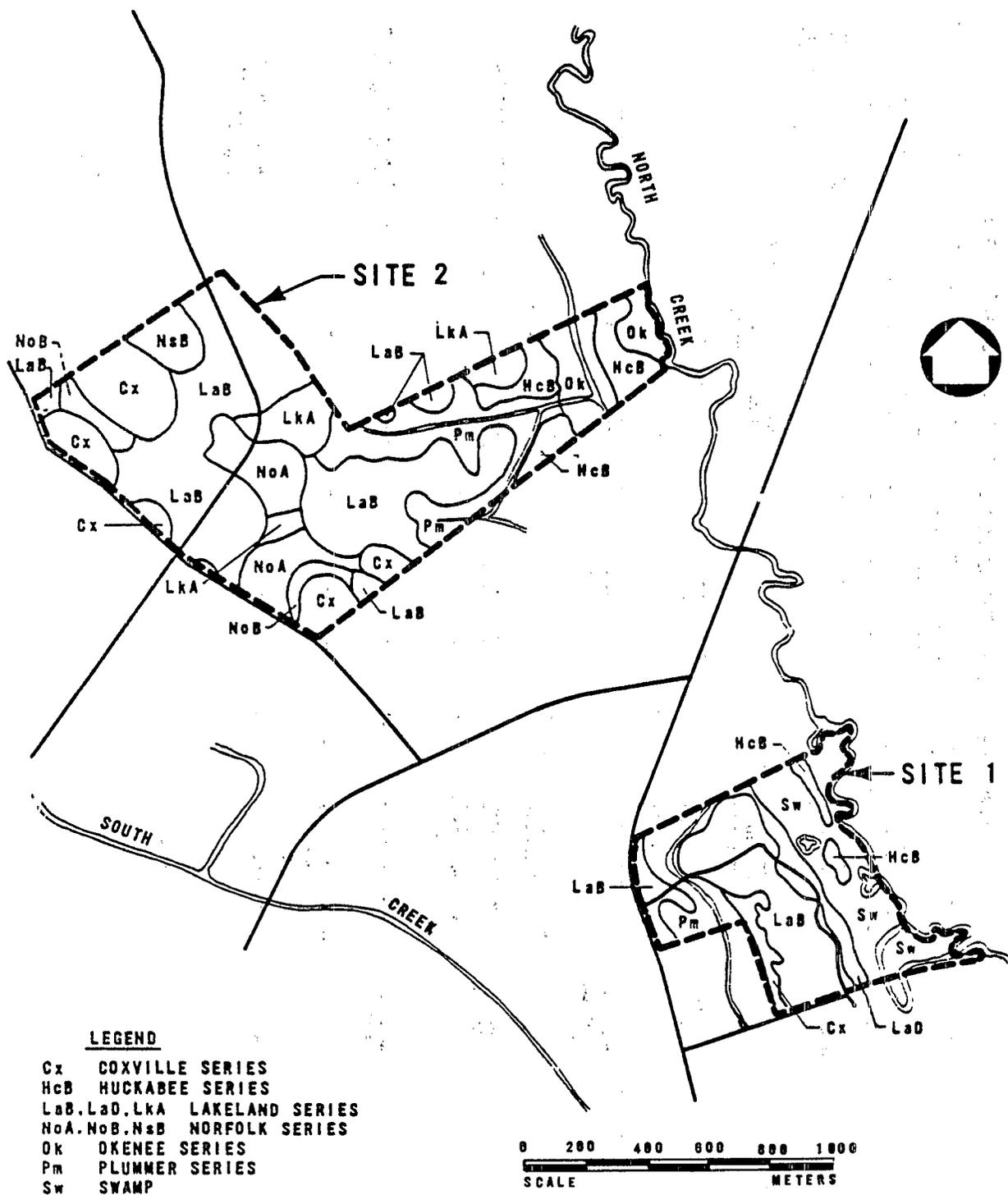

FIGURE B-1
SOILS MAP, SITES 1 AND 2

TABLE B-4
GENERAL SOIL CHARACTERISTICS, SITES 1 AND 2

SCS soil series	Depth, cm	USDA texture	Estimated permeability, cm/h	Depth to seasonal high water table, m	Drainage class	Available water capacity, cm/m	Shrink-swell potential	Structure	pH	Limitations for rapid infiltration
Coxville (Cx)	0-30	Fine sandy loam to sandy loam	0.13-0.51	0	Poor	13	Low	Crumb	5.1-5.5	Fine texture, low permeability; high water table; poor drainage; moderate shrink-swell
	30-91	Sandy clay loam to sandy clay	0.13-0.51	--	--	12	Low-moderate	Sub-angular blocky	5.1-5.5	--
Huckabee (HCB)	0-41	Sand to loamy sand	25	1.5+	Excessive	5.8	Low	Crumb	5.6-6.0	--
	41-91	Loamy sand to sand	5.1-13	--	--	5.8	Low	Crumb	5.1-5.5	--
Lakeland (Lb, LbD, LkA)	0-20	Sand	25	1.5+	Excessive	5.8	Low	Crumb	5.1-5.5	--
	20-137	Sand to loamy sand	6.4-13	--	--	5.8	Low	Structureless	5.6-6.0	--
Norfolk (NbA, NCB)	0-76	Loamy sand	6.4-13	0.9	Well	6.7	Low	Crumb	5.6-6.0	High water table
	76-107	Sandy loam	6.4-13	--	--	6.7	Low	Sub-angular blocky	5.6-6.0	--
Norfolk (NSB)	0-33	Sandy loam	2.0-6.4	0.9	Well	8.3	Low	Crumb	5.6-6.0	Fine texture; low permeability; high water table
	33-112	Sandy clay loam	0.13-0.51	--	--	8.3	Low	Sub-angular blocky	--	--
Okenee (OK)	0-33	Loam	2.0-6.4	0	Poor	12	Moderate	Crumb	5.1-5.5	Fine texture; low permeability; high water table; poor drainage; moderate shrink-swell
	33-107	Sand loam to sandy clay loam	0.51-2.0	--	--	14	Low	Sub-angular blocky	--	--
Plummer (Pm)	0-28	Loamy sand	2.0-6.4	0	Poor	6.7	Low	Crumb	5.1-5.5	Low permeability; high water table; poor drainage
	28-81	Loamy sand	0.51-2.0	--	--	5.7	Low	Sub-angular blocky	5.1-5.5	--
Swamp (Sw)	0-91	Variable	Variable	0	Poor	Variable	Low	Variable	5.1-5.5	High water table; poor drainage

B.4 Site Investigations

The selected site for RI is 2.4 km (1.5 miles) from the existing wastewater treatment facilities. The site contains 48 ha (120 acres) of land and was covered with brush and trees. Near North Creek, the ground surface drops vertically about 6 m (20 ft), forming a relatively steep bluff as indicated in Figure B-2. West of the bluff, elevation varies less than 0.6 m (2 ft).

B.4.1 Soil Characteristics

As indicated by Figure B-1 and Table B-4, the soils at Site 1 that are best suited for RI are the Lakeland sands (LaB and LaD in Figure B-1). These permeable soils are found at Site 1 only near the center of the site. Thus, RI is potentially feasible only in a limited portion of Site 1. Because it would have cost Community B as much to buy only the land needed for the treatment system as to buy the entire site (the unused portion of the site being mostly swamp and therefore undevelopable), acquisition of the entire site was necessary.

To verify that Site 1 has adequate soil depth and depth to ground water for RI, and to ascertain the absence of shallow, impermeable soil layers, nine test holes were drilled as shown in Figure B-2. A typical boring log from the investigation is presented in Table B-5. At this particular test hole, the presence of ground water at a depth of 3.2 to 3.5 m (10 to 11 ft) and an impermeable clay layer at 6.5 m (21 ft) means that percolation could occur only to a depth of about 3.2 to 3.5 m (10 to 11 ft) and that the flow of water below this depth is primarily horizontal rather than vertical.

TABLE B-5
TYPICAL LOG OF TEST HOLE

Depth, m	USDA texture	Remarks
0-1	Loamy sand	--
1-2	Sandy loam	--
2-2.2	Loamy sand	With thin silt lenses
2.2-3.2	Sand	--
3.2-3.5	Sand	Ground water table
3.5-6.5	Sand	Saturated
>6.5	Clay	Impermeable

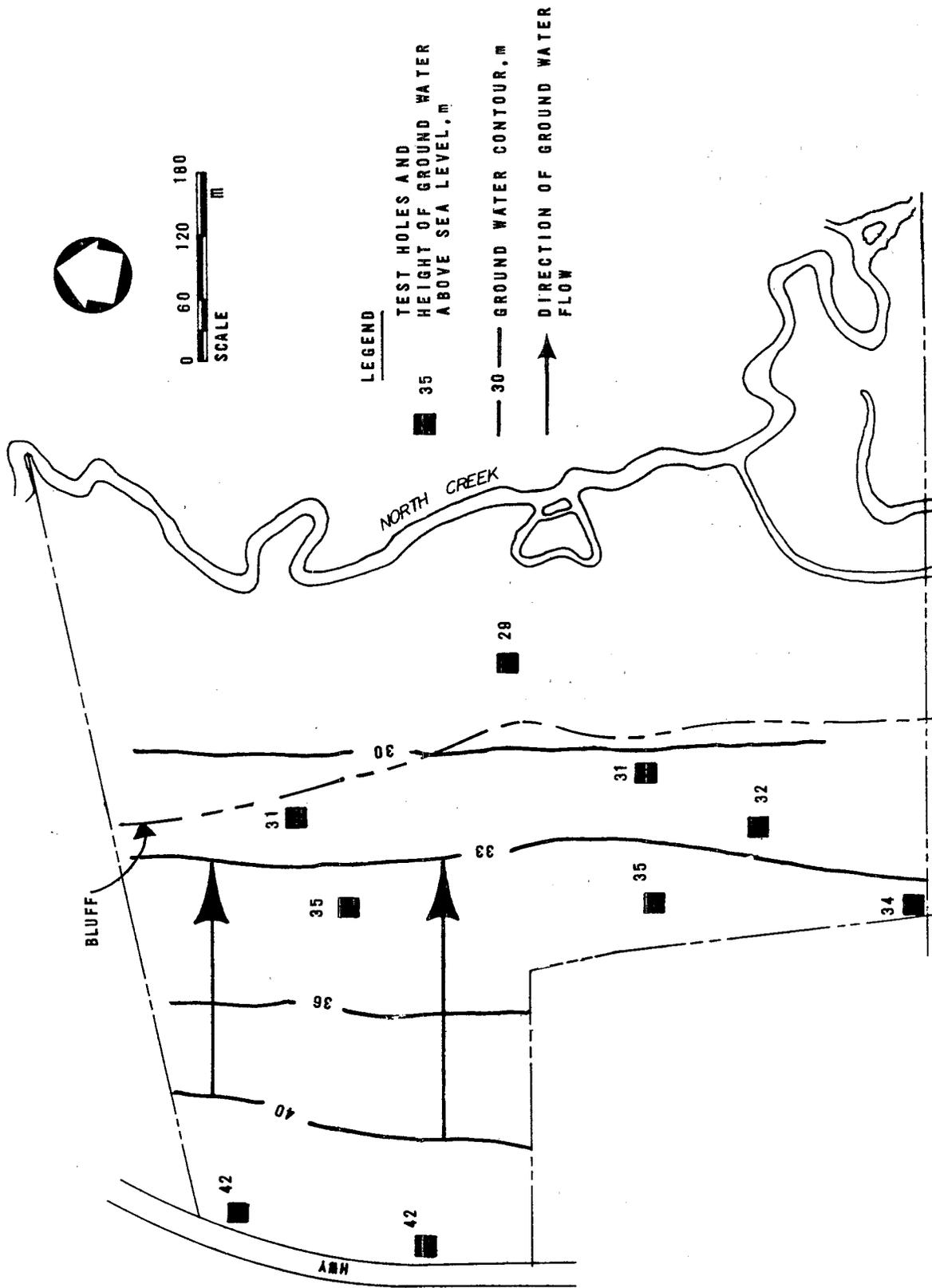

FIGURE B-2
GROUND WATER CONTOURS

B.4.2 Ground Water Characteristics

At the selected site, the depth to ground water ranges from 1.5 to 4.6 m (5 to 15 ft) and is typically 3 m (10 ft). The ground water aquifer is 1.5 to 4.6 m (5 to 15 ft) thick and is underlain by impermeable clay. The clay layer prevents deep vertical percolation and causes the ground water to flow laterally toward North Creek, as indicated by the approximated ground water contours shown in Figure B-2. Because of the shallow ground water table, there is a potential for mounding of the percolate and underdrains must be considered. Horizontal hydraulic conductivity in the aquifer was measured using the auger hole technique (Section 3.6.2.1) and averaged 3.4 m/d (11 ft/d).

Furthermore, although ground water quality is adequate for water supply purposes, the aquifer is too thin to allow production wells to extract ground water economically. The closest domestic water supply well to the RI site is 1.6 km (1 mile) southwest and upgradient of the site. This well and others in the area pump water from depths of 90 to over 150 m (300 to over 500 ft). Thus, the shallow aquifer underlying the area to be used for RI and between the RI area and North Creek will not be used as a potable water source. Current ground water quality data are presented in Table B-6.

TABLE B-6
GROUND WATER QUALITY

Parameter	Concentration
pH, units	6.8
Specific conductance, μ mhos	120
Nitrate nitrogen, mg/L	8.4
Fecal coliforms, MPN/100 mL	0

B.4.3 Hydraulic Capacity

Basin infiltration tests at the selected site were performed with clear water using 3.6 by 3.6 by 0.5 m (12 by 12 by 1.5 ft) basins filled to a depth of 22 to 30 cm (9 to 12 in.). Because the soil and ground water characteristics were generally uniform throughout the site, only two basin infiltration tests were performed. If the results of these two tests had conflicted, additional tests would have been conducted. Results from one of the two infiltration tests are plotted in Figure B-3. As shown in this figure, the resulting limiting infiltration rate at this basin was

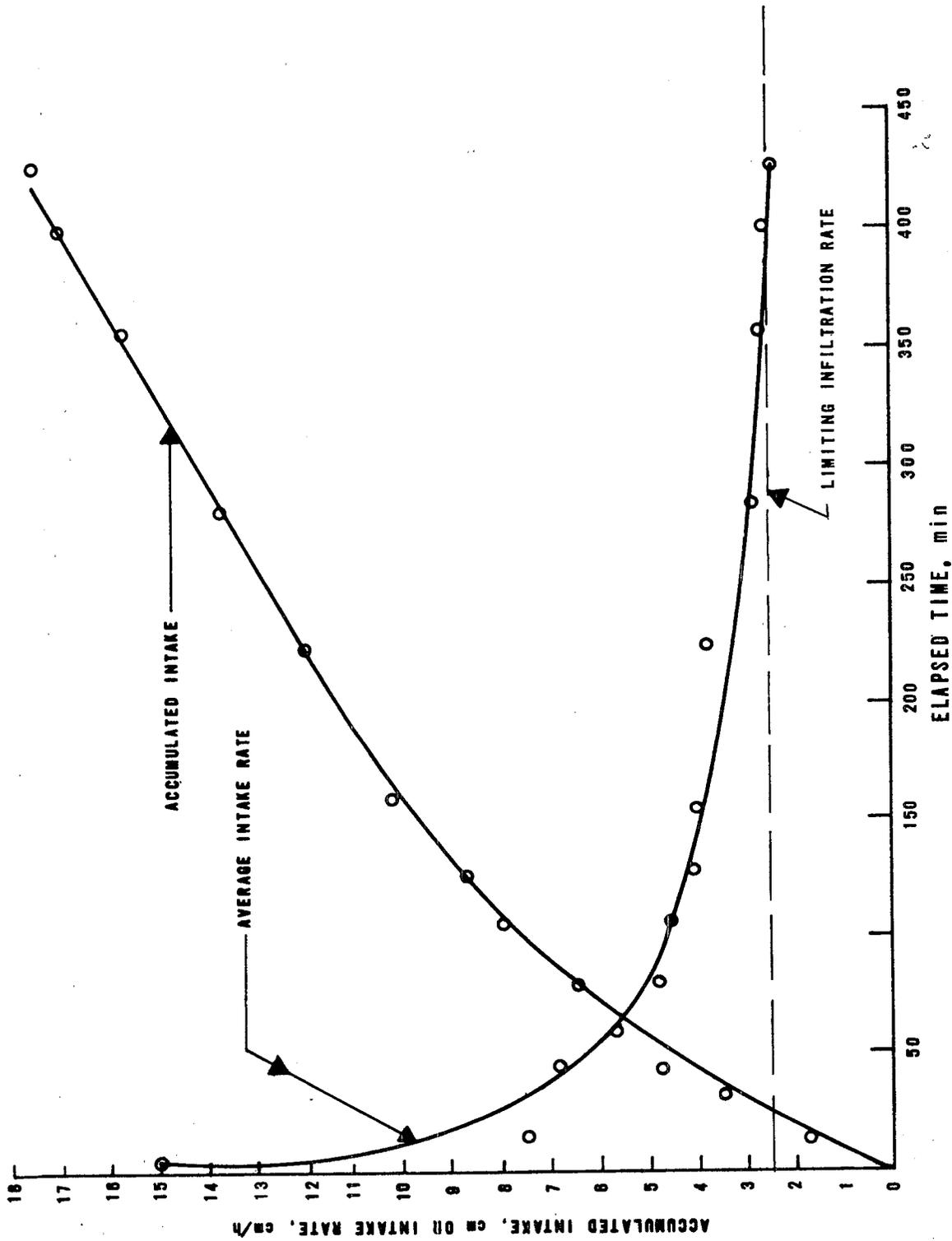

FIGURE B-3
INTAKE CURVES - INFILTRATION BASIN 1

2.5 cm/h (1 in./h). This was the minimum infiltration rate from the two tests and was used as the basis for design.

B.5 Determination of Wastewater Loading Rate

B.5.1 Preapplication Treatment Level

The existing treatment facilities are old and necessary repair work would not be cost effective. Therefore, new preapplication treatment facilities are needed. To consolidate the treatment facilities, Community B decided to locate the preapplication treatment facilities adjacent to the RI facilities at Site 1. Because Site 1 is close to the community, biological treatment prior to land treatment was appropriate (Section 5.3.1). The area experiences mild winter weather, making ponds the most cost-effective form of preapplication treatment.

The land available for preapplication treatment was somewhat limited; to minimize the pond area, an average depth of 3.6 m (12 ft) was selected. The pond design included surface aerators to be used periodically for odor control and to keep the pond from becoming entirely anaerobic. The pond was divided into three aeration cells for flexibility and reliability. A design detention time of 3 days was selected and adjustable weirs were included in each cell to allow wastewater withdrawal after 1 to 2 days if treatment efficiency is high or if the BOD:N ratio must be increased to promote denitrification during RI. The expected effluent quality from the aerated lagoons is 75 mg/L BOD₅ and 90 mg/L SS. Because of the short detention time, the nitrogen content will remain at 50 mg/L and the ammonia nitrogen content will be approximately 20 mg/L.

B.5.2 Hydraulic Loading Rate

The annual hydraulic loading rate was designed to be within 10 to 15% of the limiting basin infiltration rate (Table 5-11 and Section 5.4). A median value of 12.5% was selected and the wastewater loading rate was calculated as follows:

$$\begin{aligned} 12.5\% &\times 2.5 \text{ cm/h} \times 0.01 \text{ m/cm} \\ &\times 365 \text{ d/yr} \\ &= 27.4 \text{ m/yr (90 ft/yr)} \end{aligned}$$

B.5.3 Hydraulic Loading Cycle

Because the renovated water will flow laterally or be drained into North Creek, nitrification or ammonium nitrogen removal is necessary during the months of May through October. To maximize nitrification, a loading cycle of 2 days of flooding alternated with 12 days of drying was selected (Section 5.4.2). Using this loading cycle and the assumed loading rate, the volume of water applied during each loading cycle is:

$$\frac{(2d + 12d)/\text{cycle}}{365 \text{ d/yr}} \times 27.4 \text{ m/yr} \times \frac{100 \text{ cm}}{\text{m}} \\ = 105 \text{ cm/cycle (41.4 in./cycle)}$$

B.5.4 Effect of Precipitation on Wastewater Loading Rate

As shown in Table B-3, precipitation in Community B averages 111 cm/yr (3.6 ft/yr) and varies throughout the year from 5.5 to 15.9 cm/mo (2.2 to 6.2 in./mo). As mentioned in Section B.2.5, the wettest year in 10 would yield 137 cm (54 in.) of precipitation. This amount roughly corresponds to a maximum monthly precipitation of 20 cm/mo (8.0 in./mo). Adding maximum monthly precipitation to the average wastewater loading rate of 2.3 m/mo (7.5 ft/mo) resulted in a maximum monthly hydraulic loading rate of 2.5 m/mo (8.2 ft/mo). This combined loading rate is 13% of the test basin infiltration rate and, therefore, was acceptable (Section 5.4.1).

For land requirement calculations, the previously calculated wastewater loading rate (27.4 m/yr or 90 ft/yr) was used because precipitation is relatively insignificant most of the time.

B.5.5 Underdrainage

As discussed in Section 5.7.2, at RI sites where both the ground water table and the impermeable layer underneath the aquifer are relatively close to the soil surface, it may be possible to avoid lengthy mounding equations by using the following procedure:

1. Assume underdrains are needed.
2. Use Equation 5-4 to calculate drain spacing.
3. If the calculated drain spacing is reasonable (between 10 m and 50 m or 33 ft and 160 ft), drains should be used.

4. If the calculated spacing is less than 10 m, no mounding calculations are needed but the cost of the underdrains may cause the system not to be cost effective and may necessitate reconsideration of other sites identified during Phase 1.
5. If the calculated spacing is greater than 50 m, an evaluation of ground water mounding is necessary.

Because Site 1 is underlain by a relatively shallow impermeable layer, underdrains would be the appropriate drainage method. A drain depth of 3 m (10 ft) and an allowable ground water mound height above the drains of 0.6 m (2 ft) were assumed. Using Equation 5-4, drain spacing was calculated:

$$S = \left[\frac{4KH}{L_w + P} (2d + H) \right]^{1/2}$$

where S = drain spacing, m

K = horizontal hydraulic conductivity, m/d
= 3.4 m/d (Section B.4.2)

H = allowable height of the ground water mound above the drains, m
= 0.6 m

d = distance from drains to underlying impermeable layer, m
= 3 m

L_w = annual wastewater loading rate, m/d
= $\frac{27.4 \text{ m/yr}}{365 \text{ d/yr}} = 0.075 \text{ m/d}$

P = average precipitation rate, m/d
= $\frac{1.11 \text{ m/yr}}{365 \text{ d/yr}} = 0.003 \text{ m/d}$

$$S = \left(\frac{4 \times 3.4 \text{ m/d} \times 0.6 \text{ m}}{0.075 \text{ m/d} + 0.003 \text{ m/d}} [(2 \times 3 \text{ m}) + 0.6 \text{ m}] \right)^{1/2}$$

$$= 26 \text{ m (85 ft)}$$

Because this spacing is reasonable and will keep the mound from becoming a problem, additional mounding calculations were not necessary. Because the percolate collected in the underdrains will be discharged into North Creek, it was necessary to design the remainder of the system to meet the discharge requirements summarized in Table B-2.

B.5.6 Nitrification

To determine whether the proposed system could meet the summer ammonia nitrogen discharge requirements, the nitrification potential of the system was evaluated. First, the nitrogen loading rate was calculated as follows:

$$L_n = \frac{10C_nL_w}{365}$$

where L_n = nitrogen loading rate, kg/ha·d

C_n = applied total nitrogen concentration, mg/L

L_w = annual loading rate, m/yr

$$\begin{aligned} L_n &= \frac{10 \times 50 \text{ mg/L} \times 27.4 \text{ m/yr}}{365} \\ &= 37.5 \text{ kg/ha}\cdot\text{d} \text{ (33.5 lb/acre}\cdot\text{d)} \end{aligned}$$

This loading rate is well within the range of nitrification rates reported under favorable temperature and moisture conditions (Section 5.2.2). Because nitrification is required only during summer months when temperatures are fairly high, temperatures at the RI system will be favorable for the required nitrification. Furthermore, the relatively short application periods and longer drying periods of the selected loading cycle will ensure favorable moisture conditions and should allow virtually complete nitrification within a relatively short soil travel distance (Section 5.4.2).

B.6 Land Requirements

B.6.1 Preapplication Treatment Facilities

The average liquid depth of the aerated pond was designed to be 3.6 m (12 ft), based on an average detention period of 3 days. An additional 1 m (3.3 ft) of freeboard was provided to allow the liquid depth to vary during peak flows and emergency conditions. Each pond cell berm was designed to have a 1:3 slope (vertical:horizontal) on both interior and exterior sides and to be 1.2 m (4 ft) wide on top. Thus, the total area required for the pond is approximately 1.7 ha (4.2 acres).

B.6.2 Infiltration Basins

The area needed for infiltration was calculated as follows:

$$A = (365 Q)/(10^4 L_w)$$

where A = area required, ha

Q = average wastewater flow, m³/d

L_w = annual loading rate, m

$$\begin{aligned} A &= (365 \times 6,060 \text{ m}^3/\text{d}) / (10^4 \times 27.4 \text{ m/yr}) \\ &= 8.1 \text{ ha (19.9 acres)} \end{aligned}$$

B.6.3 Other Land Requirements

Additional land was required for berms around the infiltration basins and for access roads. Preliminary system layouts indicated that a total of about 14 ha (35 acres) would be required. This number was used for preliminary cost estimates; actual land requirements were developed during final system design.

B.7 System Design

B.7.1 General Requirements

A schematic of Community B's RI system is shown in Figure B-4. The existing screening and grit removal facilities will be retained and used because they are necessary to protect the new pumping station.

A pumping station will be constructed at the site of the abandoned treatment facilities to pump the screened wastewater through a 30 cm (12 in.) force main to the treatment ponds. Three 3.14 m³/min (830 gal/min) pumps will be included. Two pumps operated together will be able to handle a peak flow of 9,090 m³/d (2.4 Mgal/d). The third pump will be a standby. Standby power at the pumping station will be provided by a diesel generator. Distribution to the infiltration basins will be by gravity flow from the ponds.

Infiltration basins were located on the area having the most suitable soils. Because this area is relatively flat, very little grading was required and nearly equal-sized basins could be located adjacent to one another. The selected 14 day loading cycle required that at least 7 basins be constructed to enable dosing of at least one basin every 2 days. For this reason, the area having suitable soils was divided as shown in Figure B-5, with 7 basins ranging in size from 0.98 to 1.3 ha (2.4 to 3.2 acres).

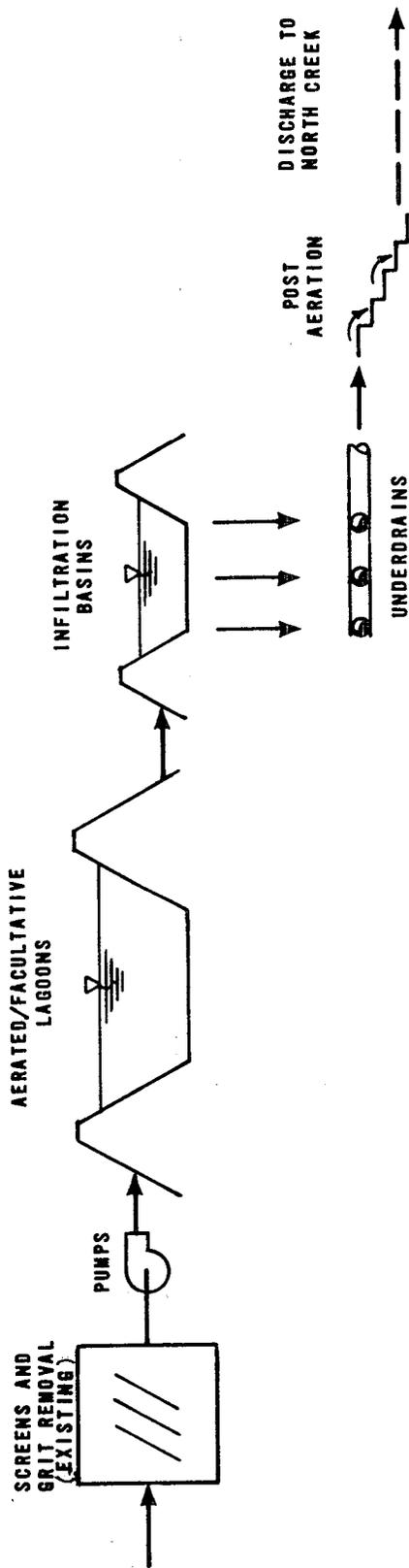

FIGURE B-4
 COMMUNITY B RAPID INFILTRATION SYSTEM FLOWSHEET

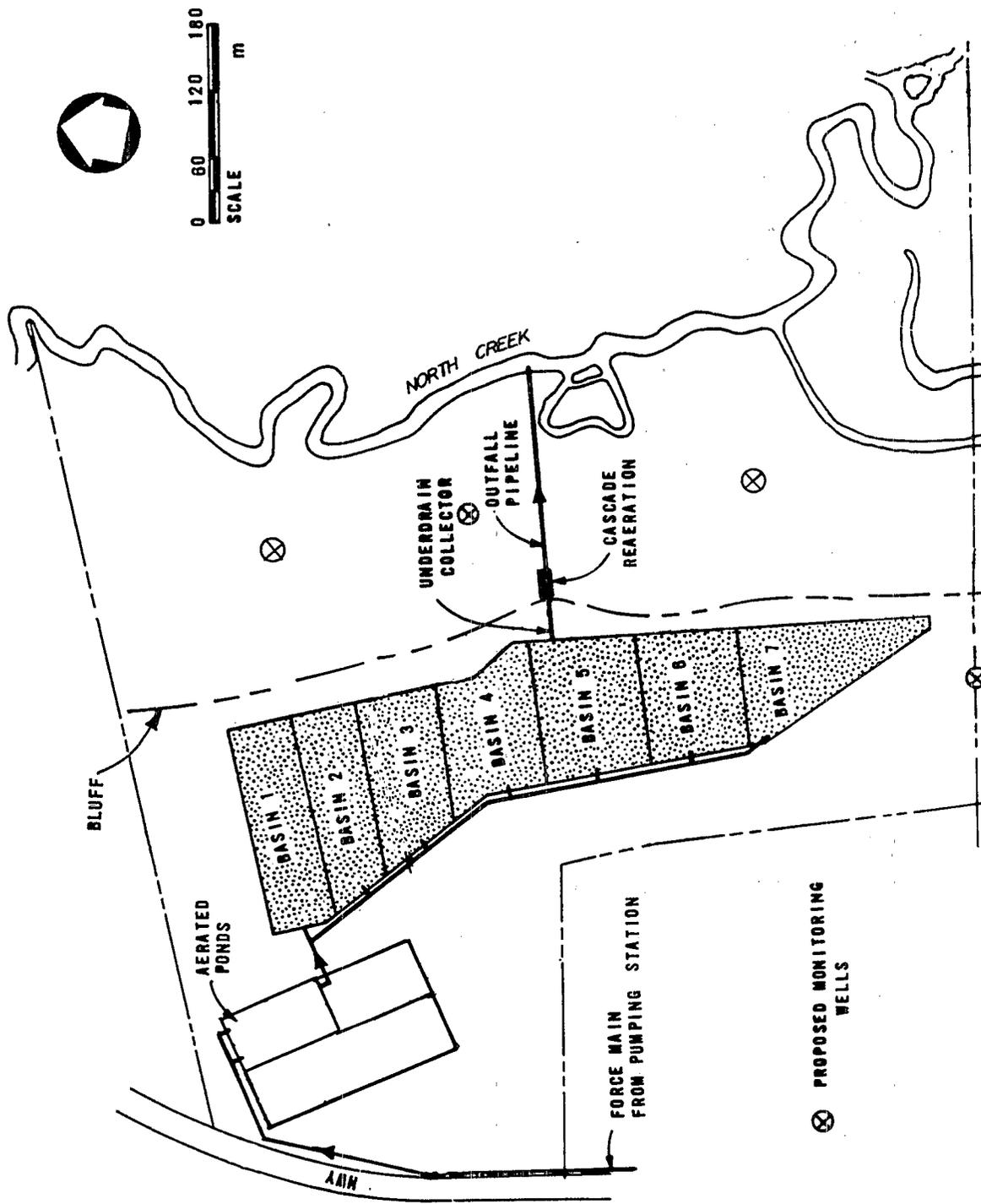

FIGURE B-5
COMMUNITY B SITE LAYOUT

To control the basin loading rate, adjustable overflow weirs were designed for each pond cell. During normal operation, the overflow weirs are to be set at the 3.65 m (12 ft) level of the pond (the average water depth). This means that the instantaneous wastewater flow to a basin at any time during a 2 day loading period will equal the wastewater flow just pumped into the pond. In other words, although the design average wastewater flowrate is 6,060 m³/d (1.6 Mgal/d), up to 9,090 m³/d (2.4 Mgal/d) may be delivered to each basin during peak flows (Section B.2.2). The peak wastewater application rate was calculated as follows:

$$R_{\max} = \frac{Q_{\max} \times 100 \text{ cm/m}}{A_{\min} \times 10,000 \text{ m}^2/\text{ha} \times 24 \text{ h/d}}$$

where R_{\max} = peak application rate, cm/h

Q_{\max} = peak wastewater flow, m³/d

A_{\min} = basin area of smallest basin, ha

$$R_{\max} = \frac{9,090 \text{ m}^3/\text{d} \times 100 \text{ cm/m}}{0.98 \text{ ha} \times 10,000 \text{ m}^2/\text{ha} \times 24 \text{ h/d}} = 3.86 \text{ cm/h}$$

In contrast, the average wastewater loading rate is:

$$R = \frac{Q \times 100 \text{ cm/m} \times N}{A_T \times 10,000 \text{ m}^2/\text{ha} \times 24 \text{ h/d}}$$

where R = average application rate, cm/h

Q = average wastewater flow, m³/d

N = number of infiltration basins

A_T = total area covered by basins, ha

$$R = \frac{6,060 \text{ m}^3/\text{d} \times 100 \text{ cm/m} \times 7}{8.1 \text{ ha} \times 10,000 \text{ m}^2/\text{ha} \times 24 \text{ h/d}}$$

$$= 2.18 \text{ cm/h}$$

Comparing the peak and average application rates to the lowest measured basin infiltration rate of 2.54 cm/h or 1.0 in./h (Section B.4.3), it can be seen that during application, infiltration would exceed application at least half the time. Also, all of the water applied during a 1 day period would infiltrate during the same period.

Therefore, the basin depth necessary to allow up to 12 hours of flooding at the peak application rate:

$$D = (A_{\max} - I) \times 12 \text{ h}$$

where D = maximum depth for wastewater, cm

A_{\max} = basin area of largest basin, ha

I = limiting infiltration rate, cm/h

$$\begin{aligned} D &= (3.86 \text{ cm/h} - 2.54 \text{ cm/h}) \times 12 \text{ h} \\ &= 16 \text{ cm (6.2 in.)} \end{aligned}$$

The required total depth was found by rounding off D to 15 cm (6.0 in.) and by adding 30 cm (12 in.) of freeboard (Section 5.6.1). The resulting design basin depth was 45 cm (18 in.). This depth should provide more than adequate freeboard during normal operations and will provide a margin of safety for unexpected conditions and emergencies.

A typical slope, of 1:2 was selected for the sides of the berms, on both interior and exterior sides, and the width of each berm was set at 122 cm (48 in.). A single road around the outer edge of the basins was included with ramps into each basin for access. With these additions, the area covered by the infiltration basins was approximately 8.3 ha (20.5 acres), including 8.1 ha (19.9 acres) available for infiltration.

B.7.2 Underdrainage

Drain laterals and a collector drain were located as shown in Figure B-6. Drain lateral sizing will vary between 15 and 20 cm (6 and 8 in.), as recommended in Section 5.7.3. The collector drain will be 20 cm (8 in.) in diameter to ensure free flowing conditions. To meet the dissolved oxygen requirements for discharge to North Creek, the renovated water will be routed through a cascade aerator placed at the bluff west of North Creek.

B.8 Maintenance and Monitoring

B.8.1 Maintenance

Occasional cleaning and ripping of the basins will be required to maintain design infiltration rates (Section 5.8.2). Also, periodic maintenance of the ponds, pumping station, screens, and grit chamber will be necessary. A staff of two full-time employees should be able to handle all the operation and maintenance needs of Community B's system (Section 2.3.3.1).



0 30 60 90
SCALE m

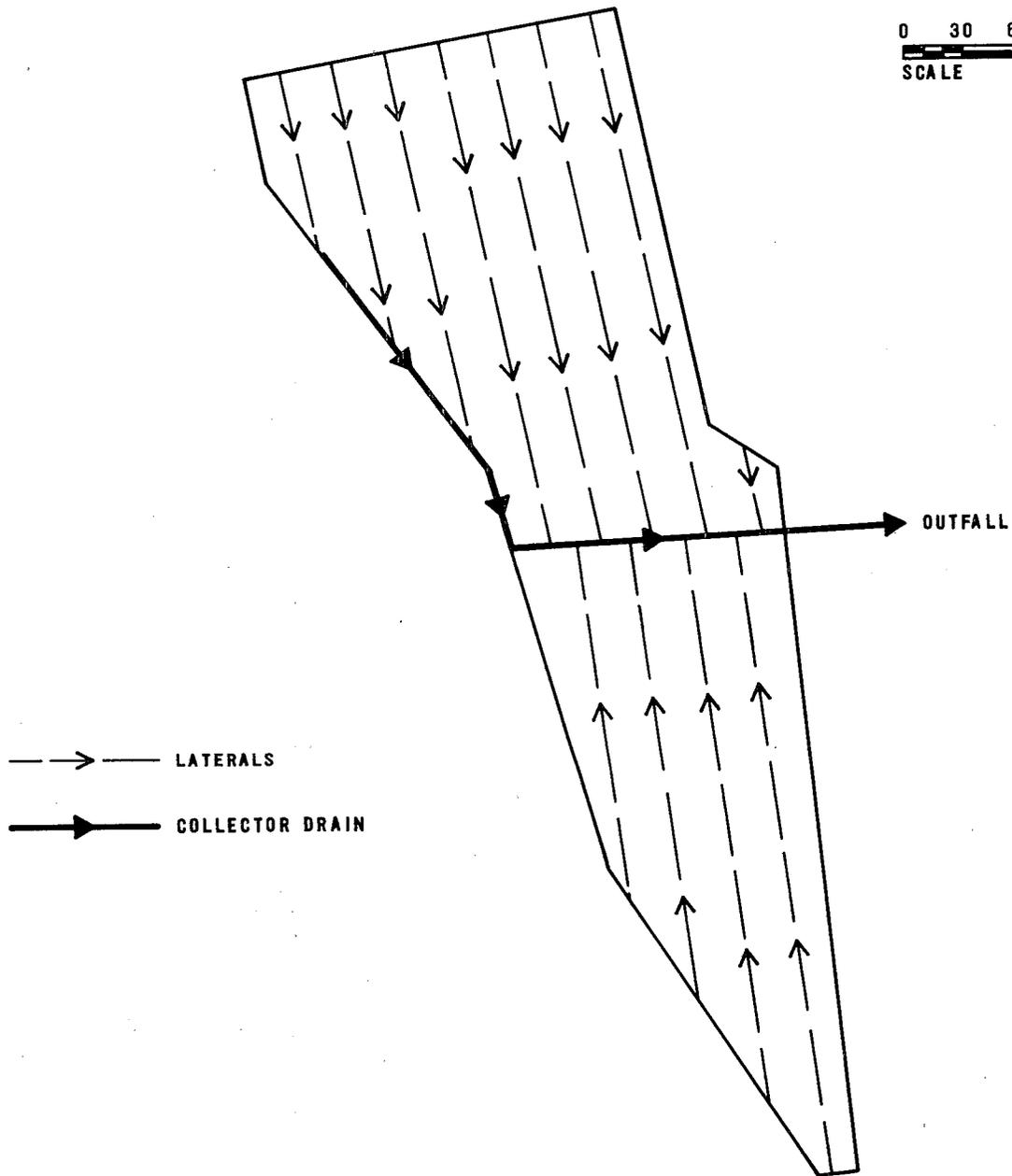

FIGURE B-6
UNDERDRAIN LOCATIONS

B.8.2 Monitoring

The renovated water will be monitored at the outfall for the parameters listed in Table B-2. Three monitoring wells to monitor ground water concentrations of ammonia nitrogen and total dissolved solids will be installed as shown in Figure B-5. An observation well will be installed between the bluff and Basin 4 to monitor ground water levels and evaluate underdrain performance.

B.9 System Costs

Total costs of Community B's RI system are presented in Table B-7. Capital costs were estimated using the EPA report on Cost of Land Treatment Systems [1]. Costs were updated to October 1980 using the EPA Sewage Treatment Plant Construction Cost Index value of 397.2. Contractor's overhead and profit are included in the cost estimates. The land was assumed to cost \$4,900/ha (\$2,000/acre). Operation and maintenance costs were estimated using the cost curves and current local prices for power and labor. Present worth was determined using an interest rate of 7-1/8% for 20 years.

B.10 Energy Budget

In Community B, energy required for land treatment will be used primarily to convey screened wastewater to the land treatment site. The amount of energy needed for this purpose can be estimated using the format presented in Section 8.6.2, as follows:

Elevation at treatment site	44 m (145 ft)
Elevation at pump station	32 m (105 ft)
Elevation difference	12 m (40 ft)
Average flow	4,208 L/min (1,111 gal/min)
Assumed pumping system efficiency	40%
Pipeline diameter	30 cm (12 in.)
Pipeline length	2,680 m (8,000 ft)
Pipeline headloss	12 m (40 ft)
Total dynamic head	24 m (80 ft)

TABLE B-7
 COST OF COMMUNITY B RI SYSTEM
 Thousands of Dollars, October 1980

Capital costs	
Transmission pumping	290
Transmission main	289
Aerated lagoons	153
Field preparation	94
Infiltration basins	153
Underdrains	65
Cascade aerator	17
Outfall pipe	18
Monitoring wells	10
Service roads and fencing	52
Standby power	48
Laboratory equipment	24
Sewer rehabilitation	113
Land acquisition	273
Legal, administrative, engineering, interest, contingencies	<u>332</u>
Total capital costs	1,931
Operation and maintenance costs	
Annual labor	15
Annual materials	7
Annual power	<u>17</u>
Total operation and maintenance costs	39
Total project costs	
Total capital costs	1,931
Present worth of operation and maintenance	<u>409</u>
Total present worth of costs	2,340
Salvage value of land	<u>(131)</u>
Net present worth	2,209

Energy requirement (using
Equation 8-2)

361,000 kWh/yr

The energy required for scarification is within the range of error of the estimated energy required to convey wastewater to the treatment site. For this reason, energy requirements for scarification are neglected. The energy required by the three cell pond would be approximately 395,000 kWh/yr. The total energy requirement of the system is 756,000 kWh/yr.

B.11 References

1. Reed, S.C., et al. Cost of Land Treatment Systems. U.S. Environmental Protection Agency. EPA-430/9-75-003. September 1979.

Appendix C

OVERLAND FLOW DESIGN EXAMPLE

C.1 Introduction

The purpose of this design example is to demonstrate the design procedures described in Section 6.4. This example represents a preliminary design suitable for Step 1 facility planning. It does not go into the details of system components such as specific equipment and hardware.

C.2 Statement of the Problem

Community C, a small rural community in the mid-Atlantic United States, has a 30 year old wastewater treatment system that is not meeting its discharge permit. The community is totally residential with no industry discharging into the sewer system and has a 20 year design wastewater flow projection of 1,890 m³/d (0.5 Mgal/d). The objective of this project is to provide the community with a wastewater treatment system capable of meeting the discharge requirements.

C.3 Design Considerations

C.3.1 Wastewater Characteristics and Discharge Requirements

The raw wastewater characteristics are presented in Table C-1. Although not listed in Table C-1, the concentrations of trace elements are within the typical range for municipal wastewater, and are therefore amenable to land treatment. The state regulatory agency has imposed the following limitations for any point source discharge; BOD₅, 20 mg/L; suspended solids, 20 mg/L; fecal coliforms, 200 MPN/100 mL.

TABLE C-1
RAW WASTEWATER CHARACTERISTICS

Parameter	Value
BOD ₅ , mg/L	200
Suspended solids, mg/L	200
Total nitrogen, as N, mg/L	40
Ammonia as N	25
Organic as N	15
Total phosphorus, as P, mg/L	10

C.3.2 Climate

Average monthly temperature and precipitation data for Community C were obtained from the U.S. Department of Commerce, National Oceanic and Atmospheric Administration (NOAA), Asheville, North Carolina, and are shown in Table C-2. A 25 year, 1 hour storm for the community was determined using the Rainfall Frequency Atlas of the United States, U.S. Department of Commerce, Technical Paper 40, and was found to yield 8.1 cm (3.2 in.).

TABLE C-2
AVERAGE METEOROLOGICAL CONDITIONS

Month	Temperature, °C	Precipitation (Pr), cm	Potential evapo-transpiration, (ET), cm	Net precipitation (Pr-ET), cm
Jan	5.2	8.7	0.3	8.4
Feb	6.2	9.3	0.2	9.1
Mar	10.0	10.2	1.9	8.3
Apr	14.7	8.8	4.3	4.5
May	19.6	9.2	9.3	-0.1
Jun	24.3	9.1	13.1	-4.0
Jul	25.8	11.2	15.6	-4.4
Aug	25.1	11.3	13.8	-2.5
Sep	22.1	8.2	9.7	-1.5
Oct	16.2	8.5	5.2	3.3
Nov	10.2	7.0	2.0	5.0
Dec	5.8	<u>9.3</u>	<u>0.2</u>	<u>9.1</u>
Year	14.2	110.8	75.6	35.2

C.4 Site Evaluation and Process Selection

C.4.1 General Site Characteristics

A preliminary site investigation determined that approximately 35 ha (86 acres) of land near the existing wastewater treatment system is available (Figure C-1). A USGS map showed the site to have a moderate to gentle slope that drains naturally into Crooked Creek, the small stream that receives the treated effluent from the existing treatment system. A large portion of the site is wooded with pines, hardwoods, and thick undergrowth.

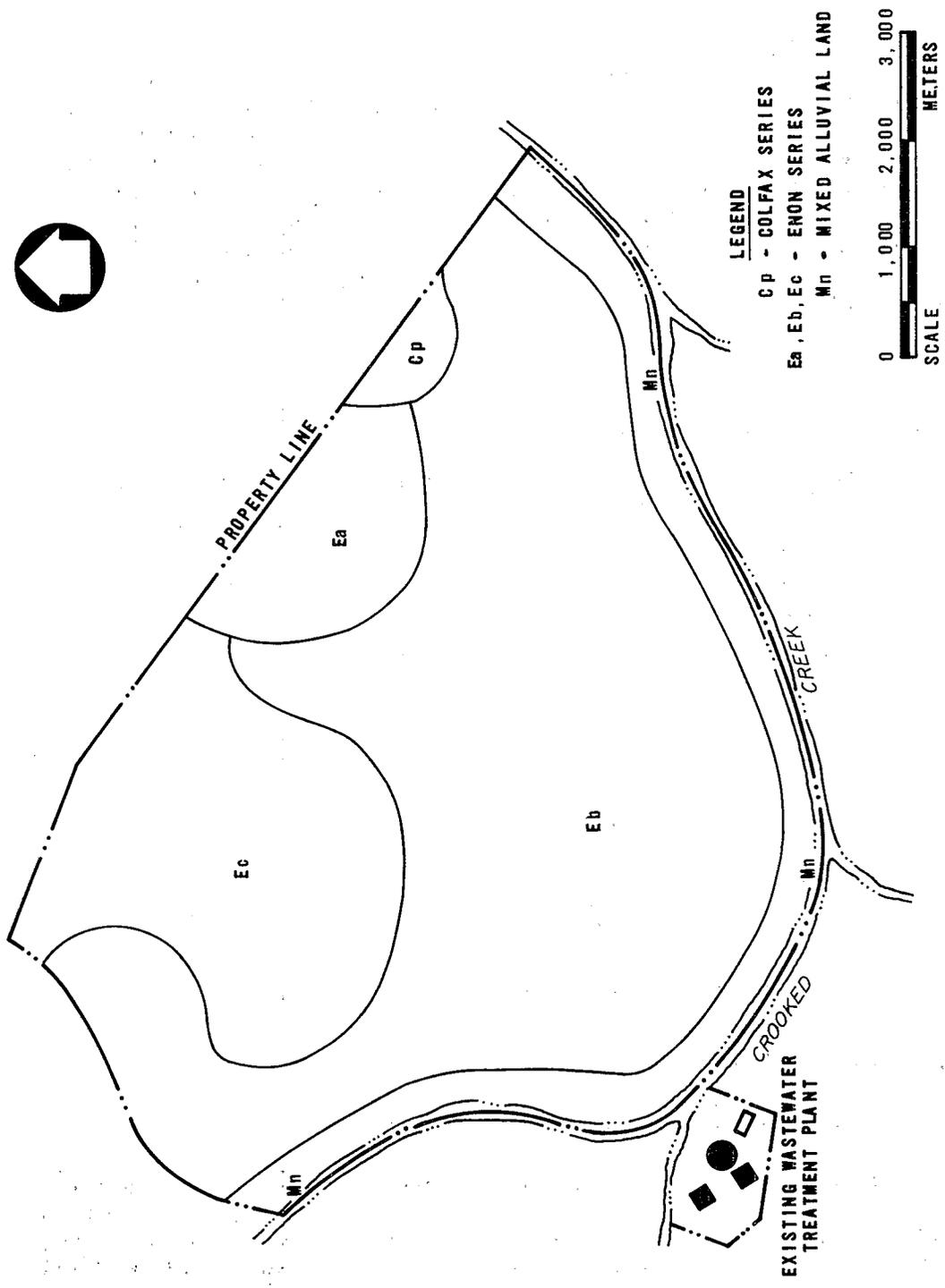

FIGURE C-1
PROPOSED OVERLAND FLOW TREATMENT SITE

C.4.2 Soil Characteristics

As shown in Figure C-1, the proposed site is dominated by soil of the Enon series. These soils have a fine sandy loam top soil underlain with clays having a slow permeability. Also present is Colfax sandy loam, which is underlain with clay loam and mixed alluvial land along the stream. Both of these soils have permeabilities ranging from slow to very slow.

C.4.3 Process Selection

The slow permeability of the Enon soils will prohibit the use of RI and will severely limit the use of this site for SR treatment. Preliminary estimates indicated that OF treatment was more cost effective than an SR system on this site and was lower in total present worth than the best conventional secondary treatment and discharge alternative. Therefore, OF treatment was the alternative selected by Community C.

C.5 Distribution Method

High pressure sprinklers are used in this example to illustrate the procedure. Gravity distribution is usually more cost effective and energy efficient. For high solids content wastewaters, such as food processing effluent, sprinklers can offer the advantage of greater solids dispersion over the application area.

C.6 Preapplication Treatment

Continued operation of the existing treatment facilities would not be cost effective because of the need for sludge treatment and disposal. A new system consisting of the minimum recommended treatment, that is, two-stage screening, was selected. An economic analysis indicated the cost savings from using less land (higher hydraulic loading rates) did not offset the cost of preapplication treatment (Section 6.3) beyond screening.

The two-stage screening system includes a coarse screen (bar rack) and a fine screen. Since sprinkler application was selected as the distribution method, the fine screen must be capable of removing particles that could clog the sprinkler nozzles. The screen mesh will be 1.5 mm (0.06 in.), as recommended in Section 6.3. The new two-stage screening system will be located at the headworks of the abandoned existing plant.

C.7 Wastewater Storage

C.7.1 Storage Requirement

The required storage for this project was calculated using historical air temperature data obtained from the NOAA in Asheville, North Carolina, and the design method described in Section 6.4 for moderate climate zones. Twenty years of data were reviewed for the air temperature limitations specified by the design method to determine the critical year, or the year that would have required the most storage. The required storage days for the critical year are given on a monthly basis in Table C-3. The total storage requirement is 44 days, or 83,160 m³ (22.0 Mgal) of wastewater at the design flow of 1,890 m³/d (0.5 Mgal/d).

TABLE C-3
STORAGE REQUIREMENTS

Month	Storage, days	Potential application, days
Nov	0	30
Dec	15.5	15.5
Jan	14.5	16.5
Feb	14.0	14.0
Mar	0	31
Total	44.0	

The storage pond will be filled only during cold weather when temperatures fall below -4 °C (25 °F). The procedure for applying the stored wastewater on the OF site is described in Section 6.5.

C.7.2 Storage Facility Description

Storage consists of a facultative pond. The design depth is 2 m (6.6 ft) and the surface area is 4.2 ha (10.4 acres). Wastewater will be diverted to storage in December, January, and February and will be drawn out of storage over the period from March through May. The daily BOD loading on the storage pond during the days of storage will be 89 kg/ha (80 lb/acre) and odors should not be a problem. The net precipitation falling on the storage pond will add 18,600 m³ (5 Mgal) so that a total of 101,760 m³ (26.9 Mgal) will have to be removed from the storage pond each spring. Seepage from the pond is neglected for the storage period.

The pond berm has interior and exterior side slopes of 3:1 (horizontal:vertical), a height above grade of 2.6 m (8.5 ft), and a crest width of 3.7 m (12 ft) which will serve as a service road. The interior berm has a 30 cm (12 in.) layer of riprap for embankment protection. The pond is lined with compacted local clay to meet applicable state requirements. The exterior berm slopes are planted to grass. The total area required for the storage pond is 5.4 ha (13.3 acres).

C.8 Selection of Design Parameters

C.8.1 Hydraulic Loading Rate

From Table 6-5, the range of hydraulic loading rates for screened wastewater application is 0.9 to 3 cm/d (0.35 to 1.2 in./d). The selected hydraulic loading rate is 1.4 cm/d (0.57 in./d). This rate has been used successfully with screened raw wastewater in a similar climate (Sections 6.4 and 6.2). A more conservative loading rate is unnecessary because prolonged subfreezing temperatures are not common. A higher loading rate during periods of near freezing temperatures would be inappropriate.

C.8.2 Application Period and Frequency

The application period selected is 8 h/d. This period can be increased to 12 h/d during drawdown from storage and during harvest periods (Table 6-5). The application frequency is 7 d/wk.

C.8.3 Slope Length and Grade

As recommended in Section 6.4.6, the minimum slope length for OF using full circle sprinklers is 30 m (100 ft) plus one sprinkler radius. The sprinklers chosen for this project (Section C.9) have a spray radius of 21.4 m (70 ft). Thus, the minimum slope length is 51.4 m (168 ft). To be more conservative, the design slope length is 61 m (200 ft). The grade will range from 2 to 4% depending on existing grades that are within this range.

C.8.4 Application Rate

Using the selected hydraulic loading rate, application period and frequency, and slope length, the application rate is calculated:

$$R_a = \frac{L_w S}{P(100 \text{ cm/m})}$$

where R_a = application rate, $\text{m}^3/\text{m}\cdot\text{h}$
 L_w = hydraulic loading rate, 1.4 cm/d
 S = slope length, 61 m
 P = application period, 8 h

$$\begin{aligned} R_a &= \frac{1.4(61)}{8(100)} \\ &= 0.071 \text{ m}^3/\text{m}\cdot\text{h} \end{aligned}$$

This is within the acceptable range from Table 6-5.

C.8.5 Land Requirements

The slope area can be calculated from Equation 6-2.

$$A_s = [Q(365) + \Delta V_s] / (D_a L_w (100))$$

where A_s = slope area, ha
 Q = average daily flow, m^3/d
 ΔV_s = net change in storage = $18,600 \text{ m}^3/\text{yr}$ (C.7.2)
 D_a = number of operating days per year
 L_w = hydraulic loading rate, cm/d

$$\begin{aligned} A_s &= [1,890(365) + 18,600] / [(365 - 44)(1.4)(100)] \\ &= 15.8 \text{ ha (39 acres)} \end{aligned}$$

C.9 Distribution System

Impact sprinklers with 7.1 mm ($9/32 \text{ in.}$) diameter nozzles operating at 41.4 N/cm^2 (60 lb/in.^2) are selected to apply the wastewater. The OF slope and the sprinkler positions are shown in Figure C-2. the sprinkler spacing of 24 m (80 ft) provides adequate overlap of the spray diameter which is 42.7 m (140 ft).

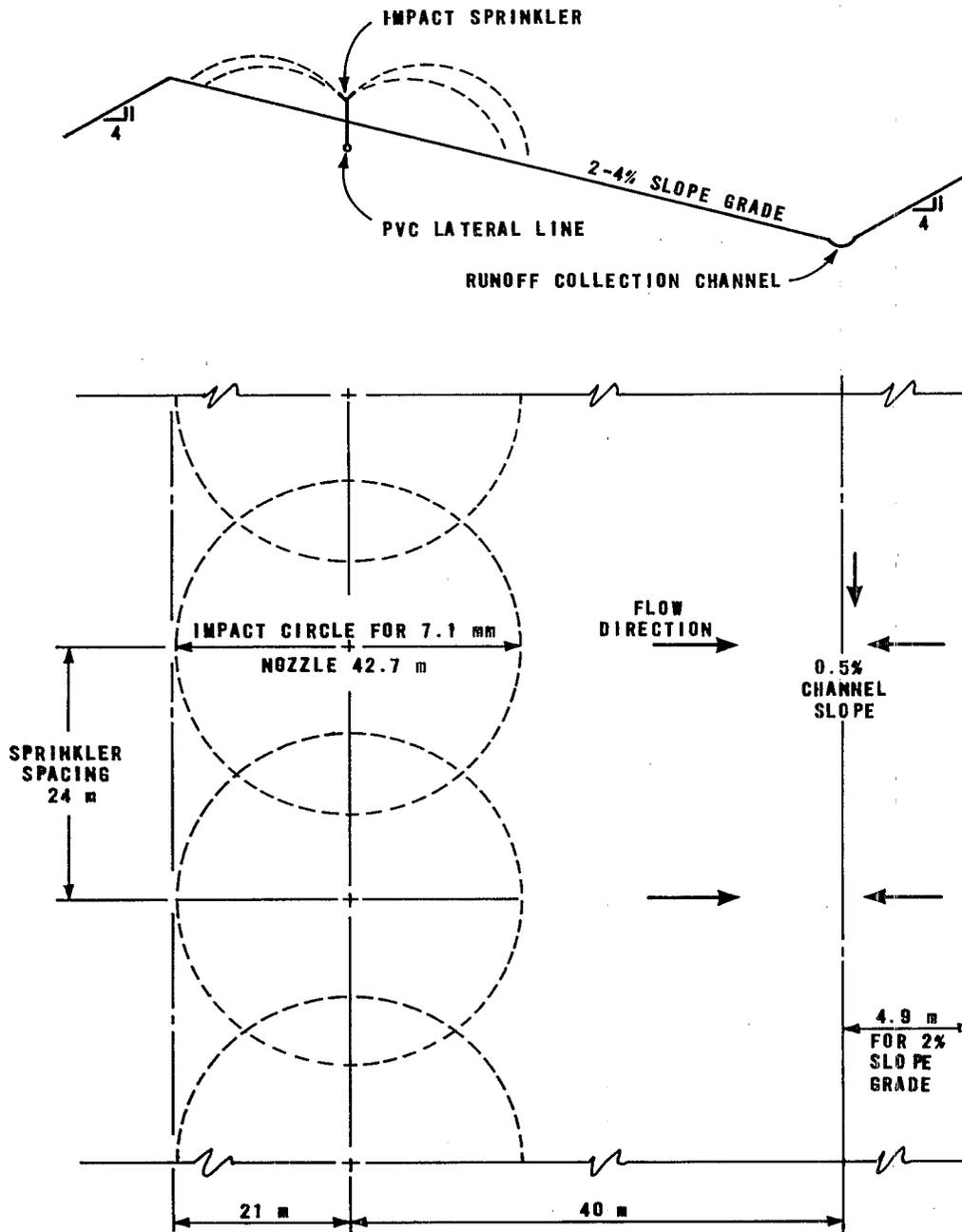

**FIGURE C-2
TYPICAL OVERLAND FLOW SLOPE**

C.10 Preliminary System Layout

The field area and slope lengths have now been determined. Given these, a preliminary layout of the treatment system was made on a USGS map using the guidelines from Section 6.6. The dimensions for storage have also been determined and were added to the overall layout. Using this and remembering that area is required for collection waterways, service roads, buffer zones, etc., the size of the survey area was determined. It can not be overemphasized that a sufficient amount of land greater than the apparent needs must be surveyed so that changes in the system layout that may occur do not require that additional land be surveyed. This not only adds a greater cost to the project, but also takes additional time that delays the design.

For this project, the entire site was surveyed so that any future expansions to the system could be performed without another survey. From this survey, a contour map with contour intervals of 0.3 m (1.0 ft) was developed (Figure C-3); however, due to the scale of Figure C-3, only the 3.05 m (10.0 ft) contours are used.

C.11 System Design

C.11.1 Treatment Slopes

Given the slope area requirements and the slope length, the contour map developed from the survey, and the site development guidelines in Section 6.6, the treatment slopes were laid out (see Figure C-4). This layout has the slopes all graded in the same direction (southeast) while the runoff collection channels convey the effluent northeast to a collection waterway. With this layout, all effluent is discharged from the site at a single point as indicated on the figure.

C.11.2 Runoff Channel Design

The runoff collection channels are formed by the intersection of the foot of one treatment slope with the backslope of the next treatment slope (Figure C-2). These channels will be graded to no greater than 25% of the slope grade of the treatment slope to prevent cross-flow on the treatment slope. This slight grade will be sufficient to cause flow to the collection waterways and will preclude the need for any type of erosion protection other than planting the channels with the same grasses as are used on the treatment slopes.

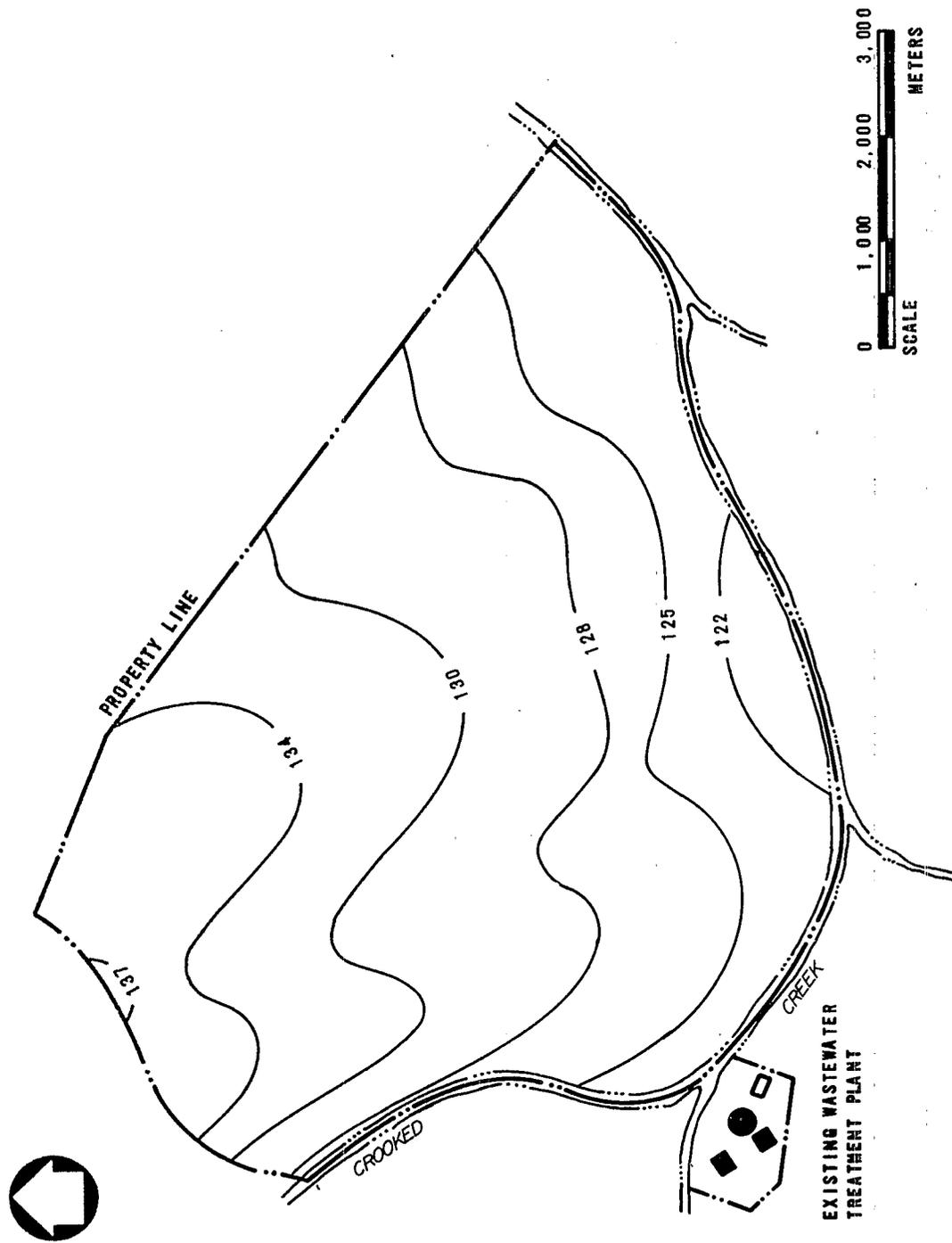

FIGURE C-3
CONTOUR MAP OF PROPOSED OVERLAND FLOW TREATMENT SYSTEM

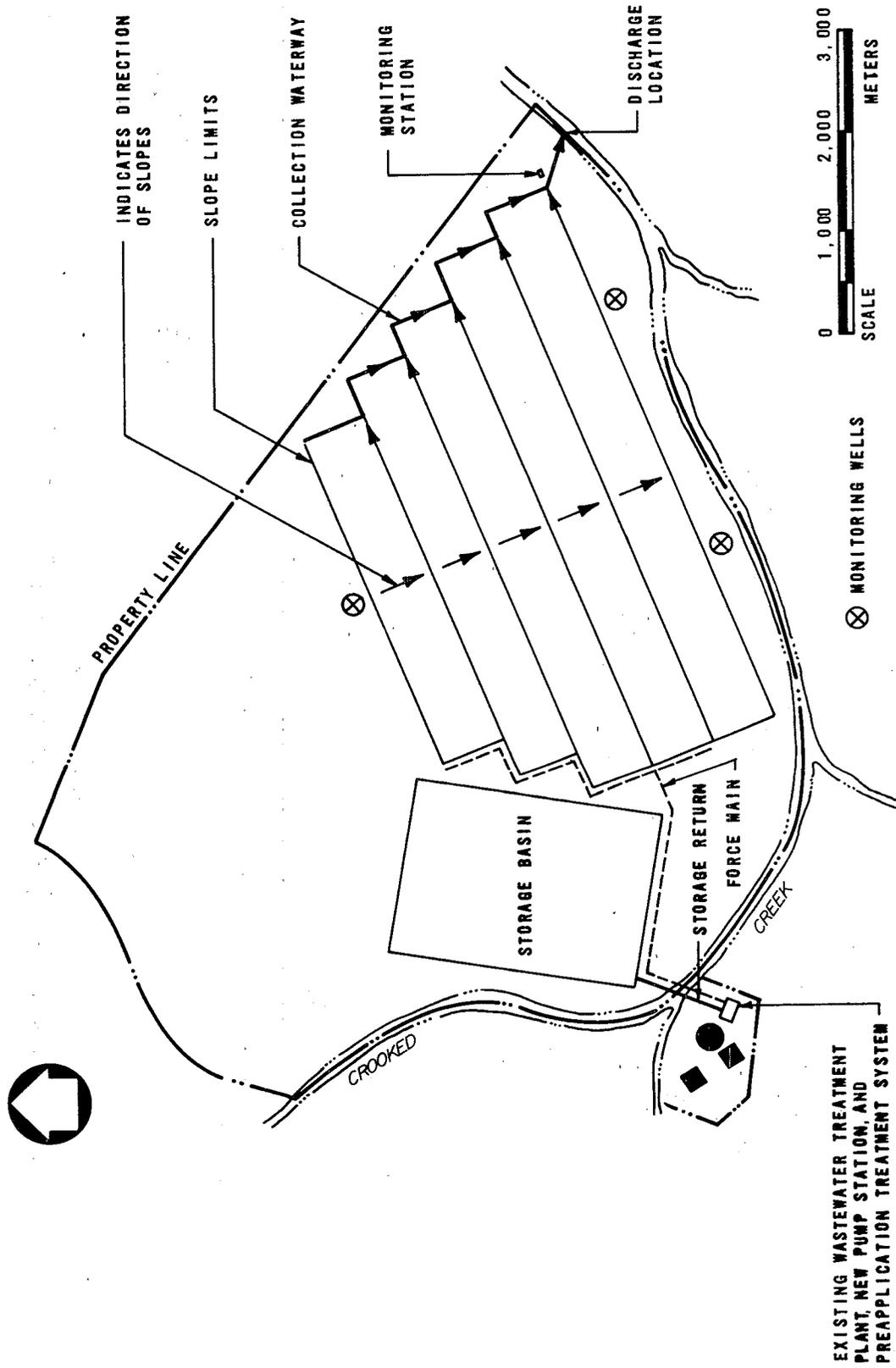

FIGURE C-4
OVERLAND FLOW SYSTEM LAYOUT

C.11.3 Collection Waterways

The collection waterways transport the effluent from the runoff collection channels to the receiving stream (Figure C-4). These waterways were designed to handle both the design runoff from the system plus precipitation that falls on the site during a 25 year storm.

The Rational Method, which can be found in any soil and water engineering text, was used to determine the storm runoff from the treatment slopes. The 25 year storm runoff for each slope was determined and the flows accumulated as each runoff collection channel contributed flow to the collection waterway. The flow increases in quantity as it comes downgrade until all runoff collection channels have fed it. Therefore, the collection waterway must also increase in size as it comes downgrade to prevent high flow velocities that cause erosion.

Working from the treatment slope with the highest elevation down (northeast corner of spray field to southeast corner), the waterway was designed for the expected effluent runoff and the 25 year stormwater flow for each section between runoff collection channels. The procedure for designing grassed waterways, which can be obtained from the SCS, was used to size each section. Since the topography of the site is such that the collection waterway will have a slope of 4% or less, there was no need for embankment protection at bends; the grass is sufficient to prevent erosion.

C.11.4 Pumping System

The pumping system includes three pumps, each with a capacity of 1,325 L/min (350 gal/min) at a total head of 72.5 m (238 ft). The headloss was determined by summing all the headlosses, from the farthestmost sprinkler back to the pump, of the critical piping path or that path that produces the greatest headloss.

The pumps work in parallel and feed a 20.3 cm (8 in.) force main that runs to the spray field. The combined capacity of the three pumps is three times the average design flowrate so there is an adequate safety factor for peak flows and diurnal fluctuations.

The pumping station is located immediately after the two stage screening unit on the existing treatment plant site. As shown in Figure C-4, the storage basin is at a higher elevation, which means wastewater must be pumped to storage and then flow back to the pumping station through a separate pipeline by gravity. Sufficient land was not available to

locate the storage basin between the screening unit and the pumping station to allow gravity flow into storage and out to the pumping station. During favorable days in the spring, a valve is opened on the return pipeline from the storage pond to the pumping station and wastewater is applied to the slopes at 1.5 times the average daily flowrate.

C.11.5 Monitoring and Collection Systems

A monitoring station is located on the site, as shown in Figure C-4. This station consists of a Parshall flume with a continuous flow metering device and a composite sampler. The Parshall flume was designed to handle the 25 year storm flow without sustaining significant damage. A standby chlorination system was installed at this location and three ground water monitoring wells were installed as shown in Figure C-4 to satisfy state regulatory requirements.

C.12 Land Requirements

The final land area requirement was determined after all the components of the OF system had been sized and located on the site plan. A 15 m (50 ft) buffer zone around the application site was recommended by the state agency since residential developments are close to the site. The buffer zone will remain wooded and will require 2.3 ha (5.7 acres) of land. All of the land requirements of the system are listed in Table C-4. Although the total land requirement is 29.3 ha (72.3 acres), the entire 35 ha (85 acre) site was purchased since the owner refused to sell only a portion of the property.

TABLE C-4
LAND REQUIREMENTS

Item	Area	
	ha	acres
Field area with collection channels	15.8	39.0
Storage pond	5.4	13.3
Buffer zone	2.3	5.7
Miscellaneous		
Roads, collection waterways, monitoring station	1.1	2.7
Surplus land ^a	4.7	11.6
Total	29.3	72.3

a. Surplus land is that land which does not fit economically into the grading plan.

C.13 Cover Crop Selection

Based on experiences with varieties of grasses at other OF systems, it was decided to use the mixture given in Section 6.7 which includes Reed canarygrass, tall fescue, redtop, dallisgrass, and ryegrass. The local agricultural agent concurred and also suggested orchardgrass be added to the mix since this grass flourished in the area.

C.14 System Costs

Total costs for the OF system for Community C are presented in Table C-5. Capital costs were estimated using the EPA technical report on Cost of Land Treatment Systems [1]. Costs were updated to September 1980 using the EPA Sewage Treatment Plant Construction Cost Index value of 362 and the EPA Sewer Construction Cost Index of 387. Contractor's overhead and profit are included in the cost estimates. The land was assumed to cost \$4,900/ha (\$2,000/acre). Operation and maintenance costs were estimated using the cost curves and current local prices for power and labor. Present worth was determined using an interest rate of 7-1/8% for 20 years.

TABLE C-5
COST OF COMMUNITY C OF SYSTEM
Thousands of Dollars, September 1980

Capital costs	
Preapplication treatment	42
Pumping	271
Force main	29
Piping to and from storage	20
Storage pond	316
Site clearing	70
Slope construction	60
Runoff collection	14
Distribution (sprinklers, laterals, controls)	72
Agriculture (preparation and seeding)	20
Service roads	24
Chlorination and flow monitoring	56
Monitoring wells	5
Contingencies (30%)	300
Land	172
Total capital costs	1,471
Operation and maintenance costs	
Annual labor	27
Annual materials	7
Annual power	8
Total operation and maintenance costs	42
Total project costs	
Total capital costs	1,471
Present worth of operation and maintenance	441
Total present worth of costs	1,912
Present worth of salvage value of land	(78)
Net present worth	1,834

C.15 Energy Budget

Pumping, crop production, and chlorination require quantifiable primary energy. For pumping raw wastewater, stored wastewater, and accumulated precipitation at a head of 72.5 m (238 ft), 222,000 kWh/yr is required. Crop harvest will require 20,000 kWh/yr and disinfection, if used, will require 5,000 kWh/yr. The total primary energy budget is 247,000 kWh/yr. If a gravity distribution system had been possible, the pumping requirements would have been reduced to about 58,000 kWh/yr due to the lower pumping head requirement of approximately 20 m (66 ft).

C.16 Alternative Design Methods - Design Example

The data used to design the OF system in the previous example will be used with the alternative CRREL and UCD design methods. These two methods determine the land area and loading requirements for a system and thus would not alter the other parts of the design procedure just used. These methods represent a rational OF design procedure, but have been used to a limited extent for design as of September 1981.

C.16.1 CRREL Method

Given:

Daily flowrate = 1,890 m³/d
Influent BOD = 200 mg/L
Effluent BOD = 20 mg/L
Storage requirement = 44 days
Volume of precipitation in storage = 18,600 m³/yr
Runoff fraction, r = 60%

Constants for the design equation are (see Section 6.11.1):

$$A = 0.52$$
$$K = 0.03 \text{ min}^{-1}$$

The necessary calculations are:

1. Calculate detention time on the slope:

$$\% \text{ BOD removal} = \frac{(1.0)(200) - 0.6(20)}{(1.0)(200)}$$

$$\times 100 = 94\%$$

Using Equation 6-8 (Section 6.11.1.2)

$$E = (1 - Ae^{-Kt})100$$

$$94 = (1 - 0.52e^{-0.03t})100$$

$$t = 72 \text{ min}$$

2. Calculate average overland flowrate. The site investigation revealed the site had a gentle slope of 4 to 6%. For design purposes, the natural slope of 5% will be used and a section size of 40 m long and 30 m wide (131 by 98 ft) will be used, based on site characteristics. The average overland flowrate is calculated using Equation 6-9 from Section 6.11.1.2.

$$\begin{aligned} q &= (0.078S)/(G^{1/3}t) \\ &= [0.078(40 \text{ m})]/[(0.05)^{1/3}(72)] \\ &= 0.12 \text{ m}^3/\text{m}\cdot\text{h} \end{aligned}$$

3. Calculate application rate. Using Equation 6-10 from Section 6.11.1.2, the application is calculated.

$$\begin{aligned} Q &= qw/r \\ &= [(0.12 \text{ m}^3/\text{m}\cdot\text{h})(30 \text{ m})]/[(1 + 0.6)/2] \\ &= 4.5 \text{ m}^3/\text{h per section} \end{aligned}$$

4. Calculate annual loading rate. An application period of 8 h/d and an application frequency of 7 d/wk will be used in this example. Since the storage requirement is 44 days and the application frequency is 7 d/wk, the number of days of application is 321 d/yr. The annual loading rate per section is therefore:

$$\begin{aligned} \text{Annual loading} &= (321 \text{ d/yr})(8 \text{ h/d}) \\ &\quad \times (4.5 \text{ m}^3/\text{h per section}) \end{aligned}$$

$$\text{Rate per section} = 11,556 \text{ m}^3/\text{yr}$$

5. Calculate total annual water volume. Given a daily flowrate of 1,890 m³ and a volume of precipitation that ends up in the storage as 18,600 m³/yr, the total annual water volume is 708,450 m³/yr.

6. Calculate land area requirements. The number of sections required is:

$$\begin{aligned}\text{No. sections} &= (708,450 \text{ m}^3/\text{yr}) \\ &\div (11,556 \text{ m}^3/\text{yr per section}) \\ &= 62 \text{ sections}\end{aligned}$$

The total area requirement is

$$\begin{aligned}\text{Area} &= [(62 \text{ sections})(30 \text{ m} \times 40 \text{ m/section}) \\ &\div 10,000 \text{ m}^2/\text{ha} \\ &= 7.4 \text{ ha (18.3 acres)}\end{aligned}$$

For comparison to the previous example, the weekly hydraulic loading rate can be calculated as:

$$\begin{aligned}4.5 \text{ m}^3/\text{h} \times 8 \text{ h/d} \times 7 \text{ d/wk} &= 252 \text{ m}^3/\text{wk} \\ 252 \text{ m}^3/\text{wk} \times (1/1,200)(\text{section}/\text{m}^2) \\ &\times 100 \text{ cm/m} \\ &= 21 \text{ cm/wk}\end{aligned}$$

C.16.2 University of California, Davis, Method

Given:

$$\begin{aligned}\text{Daily flowrate} &= 1,890 \text{ m}^3/\text{d} \\ \text{Influent BOD} &= 200 \text{ mg/L} \\ \text{Effluent BOD} &= 20 \text{ mg/L} \\ \text{Storage requirement} &= 44 \text{ days} \\ \text{Volume of precipitation in storage} &= 18,600 \text{ m}^3/\text{yr}\end{aligned}$$

Constants for the design equation are (see Section 6.11.2):

$$\begin{aligned}A &= 0.72 \\ n &= 0.5 \\ K &= 0.01975 \text{ m/h}\end{aligned}$$

The necessary design calculations are:

1. Compute the required removal ratio C_s/C_o .

$$C_s/C_o = 20/200 = 0.10$$

2. The length of slope is not restricted by topography, so select a value for the application rate (q) in the valid range of the model (see Section 6.11.2)

$$\text{Select } q = 0.16 \text{ m}^3/\text{m}\cdot\text{h}$$

3. Compute the required value of slope length (S) using Equation 6-11 from Section 6.11.2.

$$\begin{aligned} C_s/C_o &= Ae^{[(-KS)/(q^n)]} \\ 0.1 &= 0.72e^{-0.04938S} \\ S &= 40 \text{ m} \end{aligned}$$

4. Select an application period (P)

$$P = 8 \text{ h/d}$$

5. Compute the average daily flow to the OF system using 44 days of storage, a 7 d/wk application frequency, and 18,600 m^3/yr additional water in storage from precipitation.

$$\begin{aligned} Q &= [(365 \text{ d})(1,890 \text{ m}^3/\text{d}) \\ &+ 18,600 \text{ m}^3]/(365 - 44) \\ &= 2,207 \text{ m}^3/\text{d} \end{aligned}$$

6. Compute the required wetted area using Equation 6-5 from Section 6.11.2.

$$\begin{aligned} \text{Area} &= QS/qP \\ &= [(2,207 \text{ m}^3/\text{d})(40)]/[(0.16 \text{ m}^3/\text{m}\cdot\text{h}) \\ &\times (8 \text{ h})(10,000 \text{ m}^2/\text{ha})] \\ &= 6.9 \text{ ha (17.0 acres)} \end{aligned}$$

For comparison to the other examples, the weekly hydraulic loading rate can be calculated as:

$$(2,207 \text{ m}^3/\text{d})(7 \text{ d/wk}) = 15,449 \text{ m}^3/\text{wk}$$

$$(15,449 \text{ m}^3/\text{wk})(1/68,500 \text{ m}^2)(100 \text{ cm/m}) = 22.6 \text{ cm/wk}$$

C.16.3. Comparison of Methods

Although the CRREL and UCD equations appear different, the basic approach and calculation method are quite similar. Combining and rearranging Equations 6-8 and 6-9 from the CRREL method produce:

$$M_s/M_o = 0.52e^{(-0.00234S)/(G^{1/3}q)} \quad (6-13)$$

where M_s = mass of BOD at point S, kg
 M_o = mass of BOD at top of slope, kg
 S = slope length, m
 q = average overland flowrate, $m^3/m \cdot h$
 G = slope grade, m/m

This is quite similar to the UCD Equation 6-11:

$$C_s/C_o = 0.72e^{(-0.01975S)/(q^{0.5})}$$

All terms as defined previously.

The major difference in these two rational approaches are the use of slope as a variable in the CRREL equation and the value of the coefficients and exponents. Comparison of the results from all three methods are tabulated below:

<u>Method</u>	<u>Land area, ha</u>	<u>Slope length, m</u>	<u>Hydraulic loading, cm/wk</u>
Traditional	15.8	60	10
CRREL	7.4	40	21
UCD	6.9	40	22.6

The major difference between the three methods is the slope length required. The hydraulic loadings are similar since the traditional method would permit at least 15 cm/wk during the warm months. The CRREL and UCD methods are based on assumed gravity distribution, so a shorter slope can be used since there is no need to provide space above the application point for full circle sprinkler impact. If gravity application had been used in the traditional design, the gated pipe could have been placed at the sprinkler nozzle location shown in Figure C-2. This would result in a 40 m (130 ft) slope length which is identical to that determined by the rational methods.

C.17 References

1. Reed, S.C. et al. Cost of Land Treatment Systems. U.S. Environmental Protection Agency. EPA-430/9-75-003. September 1979.

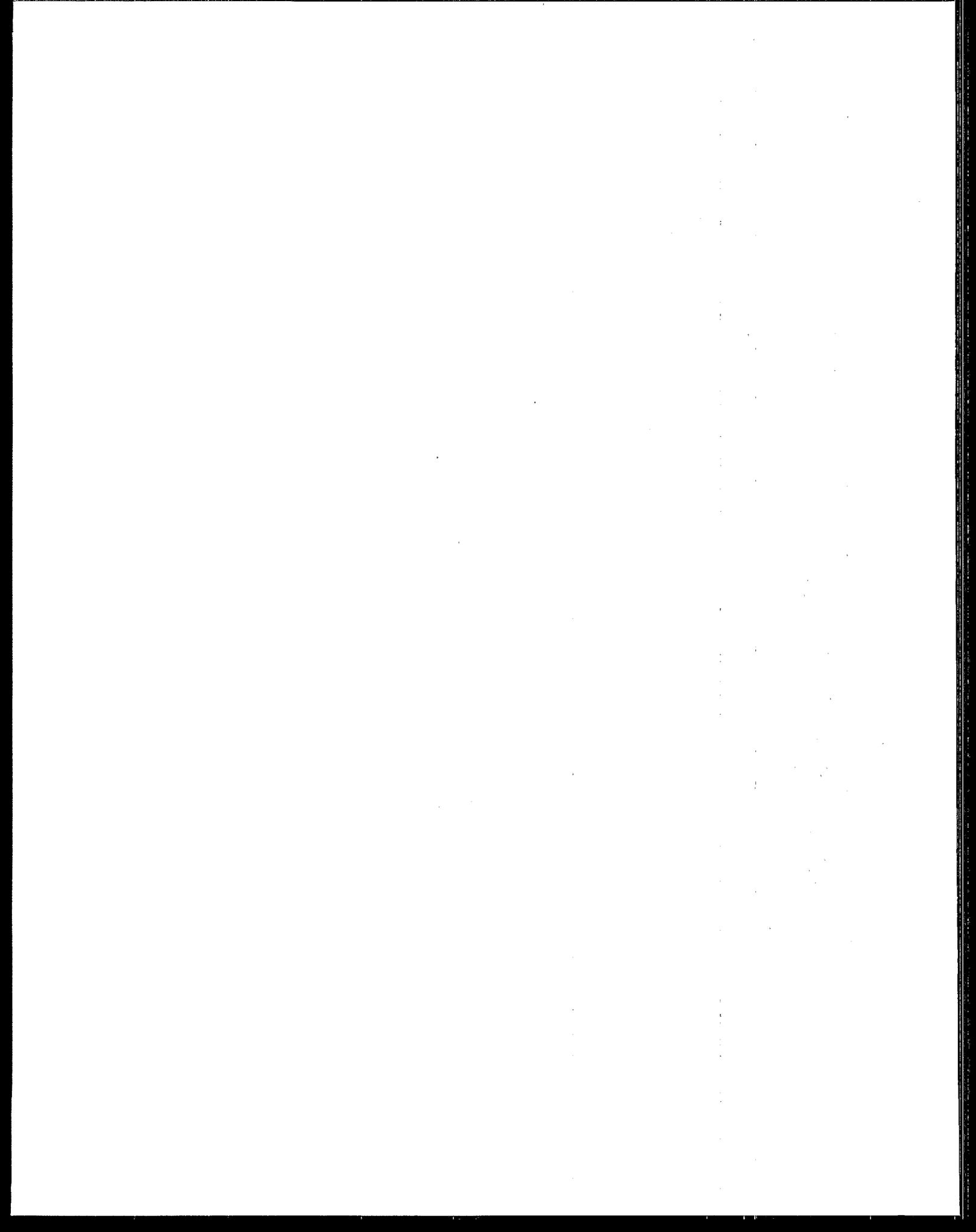

APPENDIX D

LOCATION OF LAND TREATMENT SYSTEMS

This appendix contains lists of publicly owned treatment facilities and selected industrial facilities that employ land treatment. The lists were derived from a variety of sources including the EPA Needs Surveys, the literature, and individual states' lists and the Corps of Engineers.

The number of land treatment systems increased steadily from about 300 in 1940 to about 700 in 1976. It is probable that there are more industrial and more private land treatment systems than there are publicly owned land treatment systems. The present count of publicly owned land treatment systems is 839 SR, 323 RI, and 18 OF systems that are operating or are under construction in 1981.

D.1 Slow Rate Systems

	Village Center Village Inn at Wisp White	Mississippi Arkabutla Lake
		North Carolina Pine Hurst Seaboard Woodland
<u>REGION I</u>	<u>Virginia</u> John Kerr Lake	<u>South Carolina</u> Hilton Head Isl. (Bread Crk) Hilton Head Isl. (Forest Beach) Hilton Head Isl. (Plantation) Sea Pines
<u>Maine</u> Greenville	<u>Pennsylvania</u> Benner Twp (Bureau of Corr.) Gettysburg Hamilton Twps Kennett Square State College	<u>REGION V</u>
<u>Massachusetts</u> Franklin		<u>Illinois</u> Camp Point Rend Lake, Big Muddy River
<u>New Hampshire</u> Mt. Sunapee Wolfeboro	<u>REGION IV</u>	<u>Indiana</u> Kewanna
<u>Vermont</u> West Dover	<u>Florida</u> Apopka Bay County Brevard County Coco Beach East Point Elgin AFB Fort Walton Beach Hilliard Jennings Largo L. Buena Vista (Disneyworld) Lynn Haven MacDill AFB Marco Island Newsberry Okaloosa County Pensacola (Scenic Hills) St. Petersburg Tallahassee Tyndall AFB Venice Winter Haven Zephyr Hills	<u>Michigan</u> Allegan Belding Bellaire Beulah Bloomingdale Bowne Township Caledonia Cassopolis Chatham Clarence Township Clark Township Colon Columbiaville Crystal Township Denton Township East Jordan Farwell Fremont Grayling Harbor Springs Harrison Hart Honor Houghton Co. BPW Kalkaska Kingsley Lake Odessa
<u>REGION II</u>		
<u>New Jersey</u> East Windsor Neptune		
<u>REGION III</u>		
<u>Maryland</u> Caroline Acres Deep Creek Lake Highlands Rossmoor St. Charles Snowden's Mill Swanton Tuckahoe		
	<u>Georgia</u> Braselton Camp Oliver (Ft. Stewart) Clayton Co. (R.L. Jackson) Holiday Trav-L-Park (Lowndes Co.) Jonesboro (Clayton Co.) Kings Bay (Navy) Skidaway Island Stonewall Courthouse (Fulton Co.)	

Lawton
Leoni Township
Livingston Co.
Mackinaw
Manton
Marion
Markey-Houghton
McBain
Middleville
Muskegon
Paw Paw
Pinckney
Quincy
Ravenna
Roscommon
Springport
Sunfield
Union City
Vermontville
Wayland
Wixom
Whitehall
Webberville

Minnesota
Annandale
Battle Lake
Beardsley
Belgrade
Belle Plaine
Blackduck
Breezy Point
Cass Lake
Detroit Lakes
Eden Valley
Elysian
Frazee
Hayward
Henning
Kensington
Kimball
Lake Henry
New Auburn
New York Mills
Ortonville
Paynesville
Pequot Lakes
Walker
Watkins
Wyoming

Ohio
Deer Creek

Wisconsin
Arena
Avoca
Sauk City
Stone Lake

REGION VI

Arkansas
Amity Landing, DeGray Lake
Caddo River

New Mexico
Alamogordo
Cimarron
Clayton
Clovis
Deming
Dexter
Eunice
Gallup
Jal
Lordsburg
Los Alamos

Loving
Lovington
New Mexico Dept of Corr.
(Santa Fe Co.)
Portales
Raton
Roswell
San Jon
Silver City
Tularosa

Oklahoma
Amber
Apache
Bixby
Boise City
Byng
Calumet
Carter
Clinton
Cordell
Crescent
Davidson
Devol
Dill City
Duncan
Edmond
El Reno
Erick
Fairview
Frederick
Gage
Garber
Geary
Granite
Helena
Hobart
Hydro
Kingfisher
Lahoma
Laverne
Lone Wolf
Moore
Noble
Ochelata
Oklahoma City (Willow Ck)
Pauls Valley
Pond Creek
Sentinel
Shattack
Spencer
Sportsmans Acres
Stillwater
Terral
Tupelo
Velma

Texas
Abernathy
Abilene
Albany
Amarillo
Amherst
Andrews
Anson
Anton
Aspermont
Austin (Williamson)
Benjamin
Bexar County
Big Lake
Blanco
Bonham
Booker
Bovina

Brady
Brownfield
Burnett
Castroville
Chillicothe
Claude
Clyde
Coahoma
Coleman
Colorado City
Comfort
Crane
Crockett County
Crosbyton
Cross Plains
Crystal City
Dalhart
Darrrouzett
Del Rio
Denver City
Devine
Dimmitt
Dublin
Dumas
Earth
Eldorado
El Paso (Ascarte)
El Paso (Fabens)
El Paso (Socorro)
Estelline
Fabens
Falfurias
Falls City
Farwell
Florence
Floydada
Pt. Stockton
Fredericksburg
Freer
Friona
Fritch
Georgetown
Goldsmith
Goldthwaite
Gorman
Graford
Grandfalls
Granger Lake
Greenfield
Groom
Gustine
Hale Center
Happy
Hart
Hedley
Hereford
Holliday
Hondo (East)
Hondo
Houston (CIWA)
Idalou
Ingleside
Johnson City
Karnes City
Kermit
Kerrville
Kilgore
Kingsville
Kress
Lamesa
Levelland
Littlefield
Llano
Lockney
Lorraine
Lorenzo
Lubbock
Lubbock (NW)

Lubbock (Yellowhouse)
McCamey
McLean
Mason
Matador
Mathis
Meadow
Memphis
Midland
Miles
Monahans
Morton
Muleshoe
Munday
New Home
Nordheim
North Fork Lake
Odonnell
Olton
Orange Grove
Ozona
Paducah
Pearsall
Pecos
Perryton
Petersburg
Plains
Poteet
Poth
Premont
Quitaque
Ralls
Rankin
Richland Springs
Rio Grande City
Roaring Springs
Robinson (North)
Robinson (South)
Roby
Ropesville
Roscoe
Rotan
Runge
Sabinal
San Angelo
San Angelo (Airport)
San Antonio (partial)
San Suba
Santa Anna
Seagraves
Seminole
Shallowater
Shamrock
Silverton
Slaton
Snyder
Somerville Lake
Sonora
Stanton
Stinnett
Stockdale
Stratford
Sudan
Sundown
Sunray
Sweetwater
Tahoka
Texline
Tolar
Troy
Tulia
Turkey
Uvalde
Van Horn
Vega

Weinert
Wellington
Wheeler
White Deer
Wilson
Winters
Wolfford
Youth Center

REGION VII

Iowa
New Hampton
Storm Lake

Kansas
Belleville
Bucklin
Chanute
Cheney
Colby
Elkhart
Elsmore
Enterprise
Formosa
Glen Elder
Goodland
Great Bend
Hays
Hugoton
Iuka
Kinsley
Leoti
Madison
Minneola
Montezuma
Park Meadows
Parker
Plains
Plainville
Quinter
Ransom
Rolla
Russell
St. Francis
St. John
Scott City
Stockton
Sublette
Sylvia
Syracuse
Treece
Udall
Ulysses
West Plains

Missouri
Bennet Spring
Brunswick
Clarence Cannon Dam, Salt River
Clearmont
Crowder St. Park
Lockwood
Mark Twain National Forest
Montauk
Vandalia
Wright City

Nebraska
Clay Center
Davenport
David City
Gordon
Humphrey
Morrill

Oak
Phillips
Schuyler
Spaulding
Upland

REGION VIII

Colorado
Air Force Academy
Aurora
Burlington
Colo. Springs
Donala Development
Fitzsimmons AMC
Ft. Carson
Greeley
Holyoke
Inverness Development
Lake of the Pines
Northglenn
Snowmass
Steamboat Springs
Tammeron Development
Taylor Park
Wray

Montana
Aerial Fire Depot
Big Sky Development
Eureka
Rexford
Richey
Roberts
Rocky Boy
Roy

North Dakota
Alexander
Bowman
Dickinson
Sheyenne
Valley City
Watford

South Dakota
Eagle Butte
Gettysburg
Huron
Lake Andes
Mitchell

Utah
Bear River Central Disposal
Heber
Provo River Central Disposal
Roosevelt
Spanish Fork
Tooele
Vernal

Wyoming
Cowley
Snowy Range Central Disposal
Thayne

REGION IX

Arizona
Alpine
Arizona City
Benson
Casa Grande
Catalina
Coolidge
Ft. Huachuca
Gilbert
Joseph City

Lake Havasu (South WWTF)
Lake Havasu (Island WWTF)
Mesa
Page
Prescott
Safford
St. Johns
Taylor
Tucson
Tucson (Airport)
Williams AFB
Winslow

California
Apple Valley
Angels
Antelope Valley
Armona CSD
Arvin
Atascadero
Avenal
Bakersfield (No. 1 and 2)
Bakersfield (No. 3)
Bass Lake
Beale AFB
Bear Creek Estates
Bear Valley
Bodega Bay
Bolinias
Brentwood
Buena Vista
Butte Community College
Buttonwillow
Boulder Creek
Calif. Inst. for Men (Chino)
Calif. Med. Facility
(Vacaville)
Calif. Mens Colony (SLO)
Calipatria
Calistoga
Camarillo
Camarillo St. Hospital
Cambria
Camp Pendleton
Campo
Castle AFB
Chico
China Camp (Marin)
China Lake
Chowchilla
Clearlake Oaks
Coachella
Coachella Valley
Coalinga
Coit Ranches (Mendota)
Colfax
Corning
County Estates (Ramona)
Cutler-Orosi
Delano
Dinuba
Douglas Flat
Earlimart
Edgemont
El Dorado Hills
El Toro
Exeter
Fairfield
Fallbrook
Fed. Corr. Inst.
(Santa Barbara)
Fernbridge
Ferndale
Fontana
Forestville
Ft. Hunter-Liggett
Furnace Creek

George AFB
Golden Gate Park (SF)
Goldside Estates
Gonzales
Graton
Groveland
Guadalupe
Gustine
Half Moon Bay
Hanford
Healdsburg
Hemet
Houston Creek (Crestline)
Indian Mills
Indio
Ione
Ivanhoe
Kerman
Kern Co. Ind. Farm
King City
La Canada
La Crescenta
Laguna
Laguna Hills
La Honda
Lake Arrowhead
Lake Berryessa
Lake Berryessa (Napa Co.)
Lake Cachuma
Lake Co. (Clearlake Mighlands)
Lake Elsinore
Lake Elsinore (Canyon Lake)
Lake Hughes
Lakeport
La Mont
Las Virgines
Le Grande
Lemon Cove
Lemoore
Limoneira Ranch
Lincoln
Lindsay
Livermore
Lodi
Los Alisos
Los Angeles Co.
(Acton Rehab. Center)
Los Angeles Co.
(Lancaster)
Los Angeles Co.
(Palmdale)
Los Angeles Co.
(Warm Springs)
Los Banos
Loyalton
McFarland
Madera Co. (North Fork)
Malibu (Probation Camp)
Manteca
March AFB
Meadowood
Mendocino City
Merced
Michelson (Irvine Ranch)
Moccasin
Modesto
Mokelumne Hill
Moulton-Niguel No. 1A
Moulton-Niguel No. 3
Mt. Vernon
Murphys
Newcastle
North Fork
North Lakeport
North River No. 1
North Shore

Novato
Oakshores
Occidental
Ocotillo
Orange Cove
Pacific Union College (Angwin)
Palmdale
Palm Springs
Parlier
Perris
Petaluma
Pixley
Plymouth
Pomona
Prado Regional Park
Quincy
Ramona
Rancho California
Richardson Bay
Richardson Springs
Ridgecrest
Riverdale
Rohnert Park
Rosamond
Sacramento (Metro Airport)
San Bernardino
San Bernardino Co. No. 70
San Buenaventura
San Clemente
San Joaquin Co. Gen. Hospital
San Juan Bautista
San Luis Obispo
San Luis Rey (Oceanside)
San Pasqual Acad.
(Escondido)
Santa Maria
Santa Nella
Santa Paula
Santa Rosa (Laguna)
Santa Rosa (Oakmont)
Santa Rosa (West College)
Scotts Valley
Seeley Creek (Crestline)
Sea Ranch
Shady Glen
Shafter
Shasta Dam
Shastina
Sheridan
Smith River
Snelling
Sonoma Valley
South Tahoe
Spanish Flat
Strathmore
Sun City
Sunnymead
Sunol Valley
Susanville
(Dept of Corrections)
Sutter Creek
Taft
Tehachapi
Terra Bella
Thousand Oaks
Tomales
Tulare
Tulare Correction Center
Twentynine Palms
U.S. Vet. Admin. Hosp.
(Livermore)
Veteran Home (Yountville)
Wasco
Weed
Western Hills (Chino)

Westport
Willits
Wilseyville
Windsor
Windsor (Sonoma Co. Airport)
Winton
Woodlake
Woodland
Woodville
Woodward Bluff
Yountville

Hawaii
Hanalei
Kailua Kona
Kaunakakai
Keauhou
Lahaina
Schofield Barracks
Waimea

Nevada
Carson City
Dayton
Douglas Co.
Elko
Gerlach
Glen Meadows
Incline Village
Las Vegas (partial)
Las Vegas (Clark Co.)
(partial)
Lemmon Valley
Owyhee
Winnemucca

REGION X

Idaho
Albion
Ashton
Boise (Gowen Field)
Bottle Bay
Bruneau
Donnelly
Emmett
Garfield Bay
Hazelton
Melba
Menan
Mt. Home
New Plymouth
Plummer
Rupert
Santa
St. Anthony
Wendell

Oregon
Adrian
Arch Cape
Bly
Boardman
Brownsville (North)
Brownsville (South)
Burns
Butte Falls
Corvallis (Airport)
Cottage Grove Lake
Cove
Creswell
Culver
Dexter Lake
Eagle Point
Echo
Eugene (Airport)
Forest Grove

Freeman Creek, Dworshak Dam
Gaston
Grouse Creek, Applegate Lake
Haines
Hillsboro, West Side
Hines
Jordan Valley
Junction City
Lakeside
Lakeview
Long Creek
Lowell
Madras
Metolius
Milton Freewater
Moro
Paisley
Prairie City
Richardson Point Park
Fernridge Reservoir
Richland
St. Paul
Seneca
Sherwood
Siletz
Somerset West
Stewart Lake, Lost Creek
Sutherlin
Ukiah
Unity
Wasco
Yamhill

Washington
Camp Booneville
Cusick
Ephrata
Grandview
Naches
Prosser
Quincy
Soap Lake
Walla Walla (Industrial)
Warden
Waterville
Yakima (industrial)

D.2 Rapid Infiltration Systems

REGION I

Massachusetts
Barnstable
Chatham
Concord
Edgartown
Fort Devens
Nantucket (2)
Wareham

REGION II

New Jersey
Cranbury
Seabrook Farms (industrial)
Vineland

New York
Birchwood-North Shore
(Holbrook)
Cedar Creek (Wantagh)
College Park (Farmingdale)
County Sewer District
(Central Islip)

County Sewer District
(Holbrook)
County Sewer District
(Holtsville)
County Sewer District #5
(Huntington)
County Sewer District #11
(Ronkonkoma)
County Sewer District #12
(Holtsville)
Heatherwood (Calverton)
Huntington Sewer District
Lake George
Riverhead
Strathmore Ridge (Brookhaven)

REGION III

Maryland
Calhoun Marine
Engineering School
Fort Smallwood
Jensen's Inc. - Hyde Park
Quality Inn of Pecomore, Inc.
South Dorchester K-8 Center

REGION IV

Florida
Avon Park
Lehigh Acres
Sandlake (Orlando)
Tavares
Williston

Kentucky
Horse Cave

REGION V

Illinois
Meredosia
Sangaman Valley

Michigan

Alpha
Bangor
Baraga
Bates Township
Calumet
Chatham
Crystal Falls
Decatur
Dimondale
Edmore
Forsythe Township
Gaastra
Cedar Springs (Grand Rapids)
Grayling
Hopkins
Howard
Marcellus
Olivet
Onkama
Ottawa County Road Commission
Pentwater
Shelby
Stockbridge
Tekonsha

Minnesota
Medina

Wisconsin
 Almond
 Baldwin
 Balsam Lake
 Barron
 Birchwood
 Boyceville
 Coloma
 Deer Park
 Fenwood
 Fifield
 Fontana
 North Moraine (Glenbeulah)
 Glenwood City
 Grantsburg
 Hammond
 Haugen
 Iron River
 Kellnersville
 King Veterans Home
 Knapp
 Lone Rock
 Lyndon Station
 Maribel
 Mattoon
 Merrimac
 Milton
 Minong
 Mount Calvary
 Neshkoro
 Plainfield
 Roberts
 Rosholt
 Sand Creek
 Scandinavia
 Sextonville
 Spooner
 Spring Green
 Stetsonville
 Stone Lake
 Rozellville (Stratford)
 Kelly Lake (Suring)
 Unity
 Warrens
 Wautoma
 Wheeler
 White Lake
 Wild Rose
 Williams Bay
 Winter
 Wittenberg
 Wyocena

REGION VI

Louisiana
 Ft. Polk

New Mexico
 Hobbs
 Springer
 Vaughn

REGION VII

Nebraska
 Chapman
 Elwood

REGION VIII

Colorado
 Sterling

Montana
 Bazin
 Bozeman
 Corvallis

Plains
 Stevensville
 Victor

North Dakota
 Parshall
 Reeder

South Dakota
 Madison

Wyoming
 Jackson
 Laramie

REGION IX

Arizona
 Arcosanti (Cordes Junction)
 Lo Lo Mai Springs
 Mammoth
 Phoenix (23rd Avenue)
 Papago Tribal Wastewater
 Treatment System (Sells)
 St. David
 Thatcher
 Marana (Tucson)
 Green Valley (Tucson)
 Arizona Correctional Training
 Facility (Tucson)
 Corona de Tucson (Tucson)
 Sunrise Resort (White River)
 Wickenburg
 Willcox

California
 Applegate
 Arbuckle
 Baker
 Banning
 Barstow
 Bieber
 Pfeiffer Big Sur State Park
 Biola College (Los Angeles)
 Bishop
 Placer County (Blue Canyon)
 Blue Lake
 Blythe
 Bombay Beach
 Desert Lake (Boron)
 Bridgeport
 Buellton
 Burney
 Byron
 California City
 Calpella
 Camino Heights
 Caruthers
 Cascade Shores
 Warm Springs Rehabilitation
 Facility (Castaic)
 Ceres
 Chester
 Chualar
 Coalinga
 Corcoran
 Corona
 Courtland
 Glen Helen Rehabilitation
 Center (Crestline)
 Del Rey
 Delhi
 Desert Crest

Desert Hot Springs
 Desert Shores
 Discovery Bay
 Whittier Narrows (Los
 Angeles County, El Monte)
 Escalon
 Etna
 Farmersville
 Fillmore
 Firebaugh
 Floriston
 Fontana
 Franklin
 Fresno
 Galt
 Garberville
 Gilroy
 Gorman
 Grass Valley
 Grayson
 Greenfield
 Gridley
 Hamilton City
 Silver Lake (Helendale)
 Pleasant Ridge School
 (Higgins Corner)
 Hilmar
 Hollister
 Hopland
 Huron
 Idyllwild
 Inyokern
 Isleton
 Julian
 June Lake
 Selma Community (Kingsburg)
 Knights Landing
 La Selva Beach
 Laguna Niguel
 Lake of the Pines
 Copper Cove (Lake Tulloch)
 Laton
 Lechuza
 Linda
 Linden
 Linnell
 Livingston
 Lompoc
 Lone Pine
 Lopez Lake
 Madera
 Madison
 Malaga
 Mammoth Lakes
 Maricopa
 Mariposa
 McCloud
 McKittrick
 Mineral
 Mojave
 Montague
 Montalvo
 Moorpark
 Mt. Shasta
 Newell
 Oakdale
 Orland
 Victor Valley (Oro Grande)
 Palm Desert
 California Youth Authority
 (Paso Robles)
 Pauma Valley
 Pine Valley
 Pinecrest

Poplar (Woodville Farm)
Porterville
Portola
Rancho Ponderosa
Rancho Santa Fe
Redlands
Reedley
Rialto
Richvale
Ripon
Riverbank
Running Springs
Salida
Salton City
San Ardo
Hemet San Jacinto
San Miguel
San Onofre State Beach
Sanger
Santee
Seeley
Shelter Cove
Smith Flat
Donner Summit (Soda Springs)
Soledad
Springville
St. Helena
Stirling City
Stratford
Tipton
Tranquillity
Tres Pinos
Tahoe-Truckee
Valley Center
Weaverville
Westley
Westwood
Wheatland
Whispering Palms
Whitter (Los Angeles County,
San Jose Creek)
Willow Creek
Woodbridge
Yreka
Yuba City
Yucaipa

Hawaii
Kihei

Nevada
Alamo
Beatty
Blue Diamond
Boulder City
Empire
Eureka
Gabbs
Goldfield
Hawthorne
Henderson
Jackpot
McDermitt
McGill
Montello
Overton
Panaca
Paradise Spa
Paradise Valley
Pioche
Stead
Tonopah
Wendover
Yerington

REGION X

Idaho
Dent Acres

Washington
Ritzville

D.3 Overland
Flow Systems

REGION I

REGION II

New York
Harriman (pilot scale)

REGION III

Maryland
Beltsville
Chestertown (industrial)

Virginia
Gretna

REGION IV

Georgia
Woodburry

Mississippi
Cleveland
Falkner

South Carolina
Easley (R&D)

REGION V

Illinois
Carbondale
Fillmore

Indiana
Middleburry (industrial)

Michigan
Glenn (industrial)

Ohio
Alum Creek Lake
Napoleon (industrial)

REGION VI

Louisiana
Vinton

Oklahoma
Ada (R&D)
Heavener

Texas
El Paso (industrial)
Paris (industrial)
Rocky Point, Sulphur River
Sherman

REGION VII

REGION VIII

REGION IX

California
Davis
Davis (industrial)
Newman
Sebastopol (industrial)

Nevada
Minden-Gardnerville

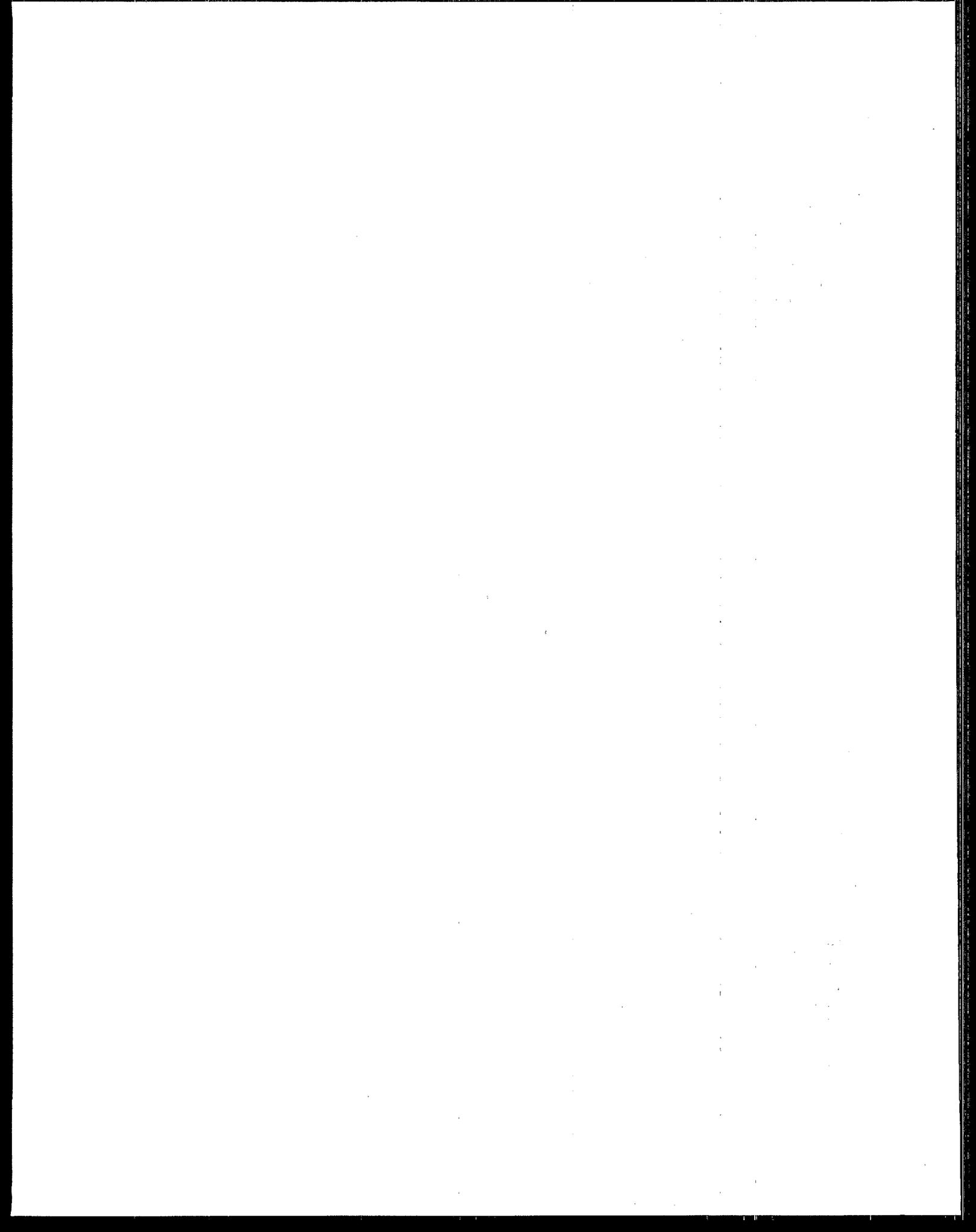

APPENDIX E

DISTRIBUTION SYSTEM DESIGN FOR SLOW RATE

E.1 Introduction

Details of distribution system design for the SR process are presented in this appendix for both surface and sprinkler distribution methods. Some aspects covered here are also applicable to RI or OF distribution techniques. The level of detail presented in this appendix is sufficient to develop preliminary layouts and sizing of distribution system components. References are cited that provide more complete design information.

E.2 General Design Considerations

Several design parameters are common to all distribution systems and are defined in the following.

E.2.1 Depth of Water Applied

The depth of water applied is the hydraulic loading per application expressed in cm (in.) and can be determined using the relationship:

$$D = L_w/F \quad (E-1)$$

where D = depth of water applied, cm (in.)

L_w = monthly hydraulic loading, cm (in.)

F = application frequency, number of applications per month

The monthly hydraulic loadings will have been established as a result of the water balance calculations developed in Section 4.5.

E.2.2 Application Frequency

The application frequency is defined as the number of applications per month or per week. The application frequency to use for design is a judgment decision to be made by the designer considering: (1) the objectives of the system, (2) the water needs or tolerance of the crop, (3) the moisture retention properties of the soil, (4) the labor requirements of the distribution system, and (5) the capital cost of the distribution system. Some general

guidelines for determining an appropriate application frequency are presented here, but consultation with a local farm adviser is recommended.

Except for the water tolerant forage grasses, most crops, including forest crops, require a drying period between applications to allow aeration of the root zone to achieve optimum growth and nutrient uptake. Thus, more frequent applications are appropriate as the ET rate and the soil permeability increase. In practice, application frequencies range from once every 3 or 4 days for sandy soils to about once every 2 weeks for heavy clay soils. An application frequency of once per week is commonly used.

The operating and capital costs of distribution systems can affect the selection of application frequency. With distribution systems that must be moved between applications (move-stop systems), it is usually desirable to minimize labor and operating costs by minimizing the number of moves and therefore the frequency of application. On the other hand, capital costs of the distribution system are directly related to the flow capacity of the system. Thus, the capital cost may be reduced by increasing the application frequency to reduce system capacity.

E.2.3 Application Rate

Application rate is the rate at which water is applied to the field by the distribution system. In general, the application rate should be matched to the infiltration rate of the soil or vegetated surface to prevent excessive runoff and tailwater return requirements. Specific guidelines relating application rates to infiltration properties are discussed under the different types of distribution systems.

E.2.4 Application Period

The application period is the time necessary to apply the desired depth of water (D). Application periods vary according to the type of distribution system, but, in general are selected to be convenient to the operator and compatible with regular working hours. For most distribution systems, application periods are less than 24 hours.

E.2.5 Application Zone

In most systems, wastewater is not applied to the entire field area during the application period. Rather, the field area is divided into application plots or zones and wastewater is applied to only one zone at a time.

Application is rotated among the zones such that the entire field area receives wastewater within the time interval specified by the application frequency. Application zone area can be computed with the following:

$$A_a = A_w / N_a \quad (E-2)$$

where A_a = application zone area, ha (acres)

A_w = field area, ha (acres) (see Section 4.5.4.1)

N_a = No. of application zones

The number of application zones is equal to the number of applications that can be made during the time interval between successive applications on the same zone as specified by the application frequency.

For example, if the application period is 11 hours, effectively 2 applications can be made each operating day. If the application frequency is once per week and the system is operated 7 days per week, then there are 7 operating days between successive applications on the same zone and the number of application zones is:

$$\begin{aligned} N_a &= (2 \text{ applications/day})(7 \text{ operating days}) \\ &= 14 \end{aligned}$$

If the field area is 100 ha (40 acres), then the application zone is:

$$\begin{aligned} A_a &= 100 \text{ ha} / 14 \\ &= 7.14 \text{ ha} \end{aligned}$$

E.2.6 System Capacity

Whatever type of distribution system is selected, the maximum flow capacity of the system must be determined so that components, such as pipelines and pumping stations, can be properly sized. For systems with a constant application rate throughout the application period, the flow capacity of the system can be computed using the following formula:

$$Q = CA_a D / t_a \quad (E-3)$$

where Q = discharge capacity, L/s (gal/min)
 C = constant, 28.1 (453)
 A_a = application area, ha (acres)
 D = depth of water applied, cm (in.)
 t_a = application period, h

Other methods of computing system flow capacity are illustrated for each of the distribution systems.

E.3 Surface Distribution Systems

E.3.1 Ridge and Furrow Distribution

The design procedure for ridge and furrow systems is empirical and is based on past experience with good irrigation systems and field evaluation of operating systems. For more detailed design procedures, the designer is referred to references [1] and [2].

The design variables for furrow systems include furrow grade, spacing, length, and stream size (flowrate) (Figure E-1a). The furrow grade will depend on the site topography. A grade of 2% is the recommended maximum for straight furrows. Furrows can be oriented diagonally across fields to reduce grades. Contour furrows or corrugations can be used with grades in the range of 2 to 10%.

The furrow spacing depends on the water intake characteristics of the soil. The principal objective in selecting furrow spacing is to make sure that the lateral movement of the water between adjacent furrows will wet the entire root zone before it percolates beyond the root zone. Suggested furrow spacings based on different soil and subsoil conditions are given in Table E-1.

The length of the furrow should be as long as will permit reasonable uniformity of application, because labor requirements and capital costs increase as furrows become shorter. Suggested maximum furrow lengths for different grades, soils, and depths of water applied are given in Table E-2.

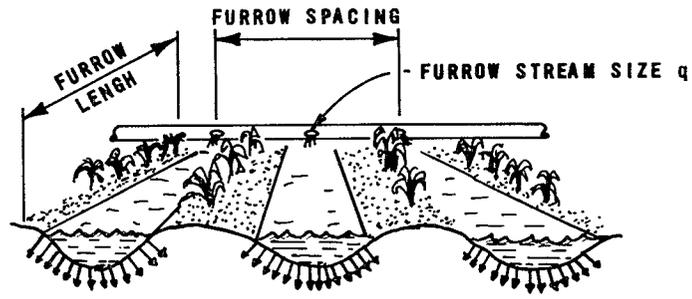

(a) RIDGE AND FURROW

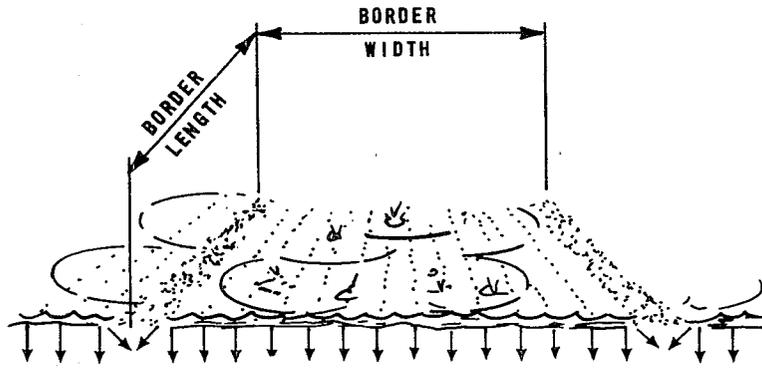

(b) GRADED BORDER

FIGURE E-1
SURFACE DISTRIBUTION METHODS

TABLE E-1
OPTIMUM FURROW SPACING [3]

Soil condition	Optimum spacing, cm
Coarse sands - uniform profile	30
Coarse sands - over compact subsoils	46
Fine sands to sandy loams - uniform	61
Fine sands to sandy loams - over more compact subsoils	76
Medium sandy-silt loam - uniform	91
Medium sandy-silt loam - over more compact subsoils	102
Silty clay loam - uniform	122
Very heavy clay soils - uniform	91

TABLE E-2
SUGGESTED MAXIMUM LENGTHS OF CULTIVATED
FURROWS FOR DIFFERENT SOILS, GRADES, AND
DEPTHS OF WATER TO BE APPLIED [1]

m

Furrow grade, %	Avg depth of water applied ^a , cm											
	Clays				Loams				Sands			
	7.5	15	22.5	30	5	10	15	20	5	7.5	10	12.5
0.05	300	400	400	400	120	270	400	400	60	90	150	190
0.1	340	440	470	500	180	340	440	470	90	120	190	220
0.2	370	470	530	620	220	370	470	530	120	190	250	300
0.3	400	500	620	800	280	400	500	600	150	220	280	400
0.5	400	500	560	750	280	370	470	530	120	190	250	300
1.0	280	400	500	600	250	300	370	470	90	150	220	250
1.5	250	340	430	500	220	280	340	400	80	120	190	220
2.0	220	270	340	400	180	250	300	340	60	90	150	190

a. From Equation E-1.

The furrow stream size or application rate is expressed as a flowrate per furrow. The optimum stream size is usually determined by trial and adjustment in the field after the system has been installed [2]. The most uniform distribution (highest application efficiency) generally can

be achieved by starting the application with the largest stream size that can be safely carried in the furrow. Once the stream has reached the end of the furrow, the application rate can be reduced or cut back to reduce the quantity of runoff that must be handled. As a general rule, it is desirable to have the stream size large enough to reach the end of the furrow within one-fifth of the total application period. This practice will result in an application efficiency of greater than 90% for most soils if tailwater is returned (see Section 4.8.2.1).

The application period is the time needed to infiltrate the desired depth of water plus the time required for the stream to advance to the end of the furrow. The time required for infiltration depends on the water intake characteristics of the furrow. There is no standard method for estimating the furrow intake rate. The recommended approach is to determine furrow intake rates and infiltration times by field trials as described in reference [2].

Design of supply pumps and transmission systems should be based on providing the maximum allowable stream size, which is generally limited by erosion considerations when grades are greater than 0.3%. The maximum nonerosive stream size can be estimated from the equation:

$$q_e = C/G \quad (E-4)$$

where q_e = maximum unit stream size, L/s (gal/min)

C = constant, 0.6 (10)

G = grade, %

For grades less than 0.3%, the maximum allowable stream size is governed by the flow capacity of the furrow, estimated as follows:

$$q_c = CF_a \quad (E-5)$$

where q_c = furrow flow capacity, L/s (gal/min)

C = constant, 50 (74)

F_a = cross-sectional area of furrow, m^2 (ft^2)

Various conveyance systems and devices are used to apply water to the head of the furrows. The most common conveyance systems are open ditches or canals (lined and unlined), surface pipelines, and buried low-pressure pipelines. For wastewater distribution, pipelines are generally used. If buried pipelines are used to convey water, vertical riser pipes with valves are usually spaced at frequent intervals to release water into temporary ditches equipped with siphon tubes or into hydrants connected to portable gated surface pipe (Figure E-2).

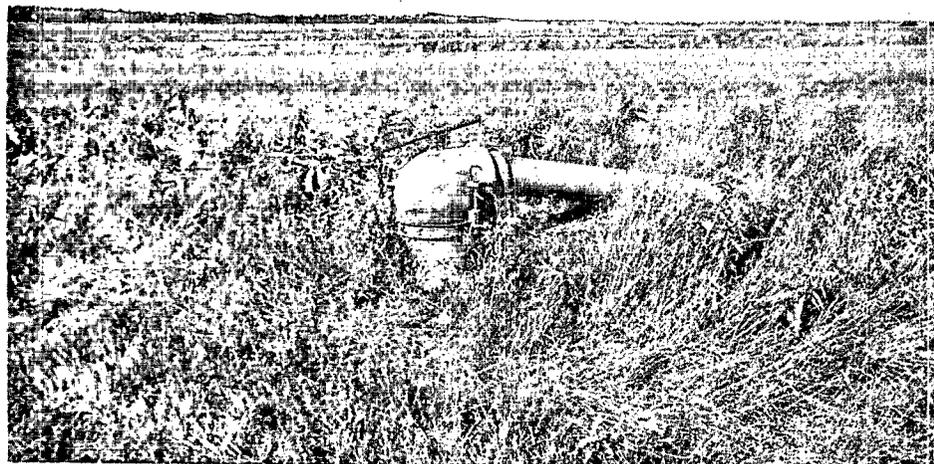

FIGURE E-2
ALUMINUM HYDRANT AND GATED PIPE
AT SWEETWATER, TEXAS

The spacing of the risers is governed either by the headloss in the gated pipe or by widths of border strips when graded border and furrow methods are alternated on the same field. The valves used in risers usually are alfalfa valves (mounted on top of the riser) or orchard valves (mounted inside the riser). Valves must be sized to deliver the design flowrate.

Gated surface pipe may be aluminum, plastic, or rubber. Outlets along the pipe are spaced to match furrow spacings. The pipe and hydrants are portable so that they may be moved for each irrigation. The hydrants are mounted on valved risers, which are spaced along the buried pipeline that supplies the wastewater. Operating handles extend through the hydrants to control the alfalfa or orchard valves located in the risers. Control of flow into each furrow is accomplished with slide gates or screw adjustable orifices at each outlet. Slide gates are recommended for use with wastewater. Gated outlet capacities vary with the available head at the gate, the velocity of flow passing the gate, and the gate opening. Gate openings are usually adjusted in the field to achieve the desired stream size.

EXAMPLE E-1: DETERMINATION OF PRELIMINARY DESIGN CRITERIA FOR A RIDGE AND FURROW DISTRIBUTION SYSTEM

Design Conditions

1. Soil conditions: sandy loam over clay
2. Final grade: 0.5%
3. Maximum monthly hydraulic loading (L_w): 40 cm
4. Application frequency (F): 4 times per month (1/wk)
5. Total field area (A_w): 100 ha
6. Crop: corn

Design Calculations

1. Determine depth of water to be applied during application.

$$\begin{aligned} D &= L_w/F && \text{(E-1)} \\ &= 40/4 \\ &= 10 \text{ cm} \end{aligned}$$

2. Determine the application zone area with Equation E-2.

Assume four applications per day will be performed, 7 d/wk.

$$\begin{aligned} \text{Application zone area } (A_a) &= \frac{A_w}{28 \text{ application zones}} && \text{(E-2)} \\ &= \frac{100 \text{ ha}}{28} \\ &= 3.6 \text{ ha} \end{aligned}$$

3. Select furrow spacing from Table E-1.

$$S_f = 76 \text{ cm}$$

4. Select furrow length from Table E-2.

$$L_f = 370 \text{ m}$$

5. Estimate maximum furrow stream size (application rate) from Equation E-4.

$$q_e = \frac{0.6}{0.5} \quad (E-4)$$
$$= 1.2 \text{ L/s}$$

This flow is used until the stream reaches the end of the furrow, at which time the flow is reduced.

6. Calculate the number of furrows used per application zone.

$$\text{No. of furrows} = \frac{(A_a) (10^4 \text{ m}^2/\text{ha})}{(L_f) (S_f) (0.01 \text{ m/cm})}$$
$$= \frac{(3.6 \text{ ha}) (10^4 \text{ m}^2/\text{ha})}{(370 \text{ m}) (76 \text{ cm/furrow}) (0.01 \text{ m/cm})}$$
$$= 127 \text{ furrows}$$

7. Calculate the maximum flow that must be delivered to each application area (distribution system capacity).

$$Q = (\text{No. of furrows}) (q_e)$$
$$= (127) (1.2 \text{ L/s})$$
$$= 152 \text{ L/s (2,417 gal/min)}$$

E.3.2 Graded Border Distribution

Preliminary design considerations for straight, graded border distribution systems are discussed here. Quasi-rational design procedures have been developed by the SCS for all variations of border distribution systems and are given in Chapter 4, Section 15, of the SCS Engineering Handbook [5].

The design variables for graded border distribution are:

1. Grade of the border strip
2. Width of the border strip
3. Length of the border strip
4. Unit stream size

Graded border distribution can be used on grades up to about 7%. Terracing of graded borders can be used for grades up to 20%.

The widths of border strips are often selected for compatibility with farm implements, but they also depend to a certain extent upon grade and soil type, which affect the uniformity of distribution across the strip. A guide for estimating strip widths is presented in Tables E-3 and E-4.

TABLE E-3
DESIGN GUIDELINES FOR GRADED BORDER
DISTRIBUTION, DEEP ROOTED CROPS [1]

Soil type and infiltration rate	Grade, %	Unit flow per 1 m of strip width, L/s	Avg depth ^a of water applied, cm	Border strip, m	
				Width	Length
Sandy, ≥2.5 cm/h	0.2-0.4	10-15	7-10	12-30	60-90
	0.4-0.6	8-10	7-10	9-12	60-90
	0.6-1.0	5-8	7-10	6-9	75
Loamy sand, 1.8-2.5 cm/h	0.2-0.4	7-10	10-13	12-30	75-150
	0.4-0.6	5-8	10-13	8-12	75-150
	0.6-1.0	3-6	10-13	8	75
Sandy loam 1.2-1.8 cm/h	0.2-0.4	5-7	10-15	12-30	90-250
	0.4-0.6	4-6	10-15	6-12	90-180
	0.6-1.0	2-4	10-15	6	90
Clay loam, 0.6-0.8 cm/h	0.2-0.4	3-4	15-18	12-30	180-300
	0.4-0.6	2-3	15-18	6-12	90-180
	0.6-1.0	1-2	15-18	6	90
Clay, 0.3-0.6 cm/h	0.2-0.3	2-4	15-20	12-30	350+

a. From Equation E-1.

TABLE E-4
DESIGN GUIDELINES FOR GRADED BORDER
DISTRIBUTION, SHALLOW ROOTED CROPS [1]

Soil profile	Grade, %	Unit flow per 1 m of strip width, L/s	Avg depth ^a of water applied, cm	Border strip, m	
				Width	Length
Clay loam, 60 cm deep over per- meable subsoil	0.15-0.6	6-8	5-10	5-18	90-180
	0.6-1.5	4-6	5-10	5-6	90-180
	1.5-4.0	2-4	5-10	5-6	90
Clay, 60 cm deep over permeable subsoil	0.15-0.6	3-4	10-15	5-18	180-300
	0.6-1.5	2-3	10-15	5-6	180-300
	1.5-4.0	1-2	10-15	5-6	180
Loam, 15-45 cm deep over hardpan	1.0-4.0	1-4	3-8	5-6	90-300

a. From Equation E-1.

The length of border strips should be as long as practical to minimize capital and operating costs. However, extremely long runs are not practical due to time requirements for patrolling and difficulties in determining stream size adjustments. Lengths in excess of 400 m (1,300 ft) are not recommended. In general, border strips should not be laid

out across two or more soil types with different intake characteristics or water holding capacities, and border strips should not extend across slope grades that differ substantially. The appropriate length for a given site depends on the grade, the allowable stream size, the depth of water applied, the intake characteristics of the soil, and the configuration of the site boundaries. For preliminary design, the length of the border may be estimated using Tables E-3 and E-4.

The application rate or unit stream size for graded border irrigation is expressed as a flowrate per unit width of border strip, L/s·m (ft³/s·ft). The stream size must be such that the desired volume of water is applied to the strip in a time equal to, or slightly less than, the time necessary for the water to infiltrate the soil surface. When the desired volume of water has been delivered onto the strip, the stream is turned off. Shutoff normally occurs when the stream has advanced about 75% of the length of the strip. The objective is to have sufficient water remaining on the border after shutoff to apply the desired water depth to the remaining length of border with very little runoff.

Use of a proper stream size is necessary to achieve uniform and efficient application. Too rapid a stream results in inadequate application at the upper end of the strip or in excessive surface runoff at the lower end. If the stream is too small, the lower end of the strip receives inadequate water or the upper end has excessive deep percolation. Actually achieving uniform distribution with minimal runoff requires a good deal of skill and experience on the part of the operator. The optimum stream size is best determined by field trials as described in reference [2]. The range of stream sizes given in Tables E-3 and E-4 for various soil and crop conditions may be used for preliminary design. Procedures given in reference [5] may be used to obtain a more accurate estimate of stream size.

The application period necessary to apply the desired depth of water may be determined from the following equation:

$$t_a = LD/Cq \quad (E-6)$$

where t_a = application period, h
L = border strip length, m (ft)
D = depth of applied water, cm (in.)
C = constant, 360 (96.3)

q = unit stream size, L/s·m of width (gal/min·ft of width)

The conveyance and application devices used for border distribution are basically the same as described for ridge and furrow distribution (Section E.3.1). Open ditches with several evenly spaced siphon tubes are often used to supply the required stream size to a border strip. When buried pipe is used for conveyance, vertical risers with valves are usually spaced at intervals equal to the width of the border strip and are located midway in the border strip. With this arrangement, one valve supplies each strip. Water is discharged from the valve directly to the ground surface, as indicated in Figure E-3, and is distributed across the width of the strip by gravity flow. For border strip widths greater than 9 m (30 ft), at least two outlets per strip are necessary to achieve good distribution across the strip. Hydrants and gated pipe can be used with border systems. Use of gated pipe provides much more uniform distribution at the head of border strips and allows the flexibility of easily changing to ridge and furrow distribution if crop changes are desired.

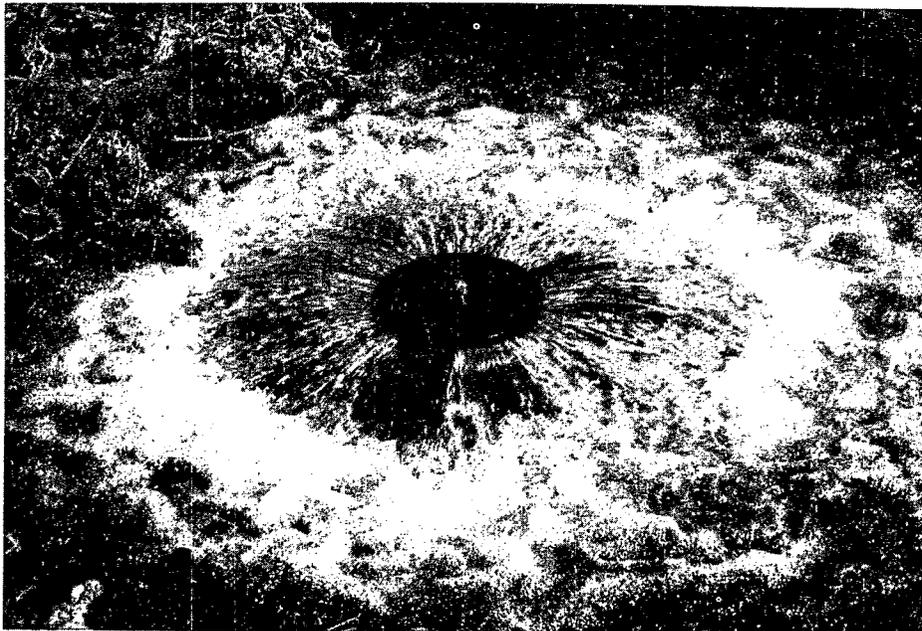

FIGURE E-3
OUTLET VALVE FOR BORDER STRIP APPLICATION

EXAMPLE E-2: DETERMINATION OF PRELIMINARY DESIGN CRITERIA
FOR GRADED BORDER DISTRIBUTION SYSTEM

Design Conditions

1. Soil conditions: deep clay
2. Final grade: 0.5%
3. Maximum monthly hydraulic loading (L_w): 40 cm
4. Application frequency (F): 4 times/month
5. Total field area (A_w): 100 ha
6. Crop: pasture

Design Calculations

1. Determine depth of water to be applied (D).

$$D = 10 \text{ cm (see Example E-1)}$$

2. Select strip width and length from Table E-4 based on design conditions.

$$W = 12 \text{ m}$$

$$L = 180 \text{ m}$$

3. Select unit stream size (q) from Table E-4.

$$q = 4 \text{ L/s}\cdot\text{m}$$

4. Estimate period of application (t_a) using Equation E-6.

$$\begin{aligned} t_a &= \frac{LD}{Cq} && \text{(E-6)} \\ &= \frac{(180 \text{ m})(10 \text{ cm})}{(360)(4 \text{ L/s})} \\ &= 1.25 \text{ h} \end{aligned}$$

5. Determine number of applications per day. Assume a 12 h/d operating period.

$$\begin{aligned} \text{No. of applications} &= (12 \text{ h/d})(1.25 \text{ h/application}) \\ &= 15 \end{aligned}$$

6. Determine application zone area (A_a). Assume application 7 d/wk.

$$\begin{aligned} A_a &= \frac{A_w}{(7 \text{ d})(15 \text{ applications/d})} \\ &= \frac{100 \text{ ha}}{105} \\ &= 0.95 \text{ ha} \end{aligned}$$

7. Determine number of border strips per application zone.

$$\begin{aligned} \text{No. of strips} &= \frac{A_a}{LW} \\ &= \frac{(0.95 \text{ ha})(10^4 \text{ m}^2/\text{ha})}{(180 \text{ m})(12 \text{ m/strip})} \\ &= 4.4 \\ &= 5 \end{aligned}$$

8. Determine system flow capacity (Q)

$$\begin{aligned} Q &= (5 \text{ strips})(W)(q) \\ &= (5)(12 \text{ m})(4 \text{ L/s}\cdot\text{m}) \\ &= 240 \text{ L/s (3,803 gal/min)} \end{aligned}$$

E.4 Sprinkler Distribution Systems

E.4.1 Application Rates

The principal design variable for all sprinkler systems is the application rate, cm/h (in./h). The design application rate should be less than the saturated permeability or infiltration rate of the surface soil (see Chapter 3) to prevent runoff and uneven distribution. Application rates can be increased when a full cover crop is present (see Section 4.3.2.4). The increase should not exceed 100% of the bare soil application rate. Recommended reductions in application rate for sloping terrain are given in Table E-5. A practical minimum design application rate is 0.5 cm/h (0.2 in./h). For final design, the application rate should be based on field infiltration rates determined on the basis of previous experience with similar soils and crops or from direct field measurements.

TABLE E-5
RECOMMENDED REDUCTIONS IN APPLICATION
RATES DUE TO GRADE [6]
Percent

Grade	Application rate reduction ^a
0-5	0
6-8	20
9-12	40
13-20	60
over 20	75

a. Percent of level ground application rate.

E.4.2 Solid Set Sprinkler Systems

Solid set sprinkler systems remain in one position during the application season. The system consists of a grid of mainline and lateral pipes covering the field to be irrigated. Impact sprinklers are mounted on riser pipes extending vertically from the laterals. Riser heights are determined by crop heights and spray angle. Sprinklers are spaced at prescribed equal intervals along each lateral pipe, usually 12 to 27 m (40 to 90 ft). A schematic layout of a solid set sprinkler system is shown in Figure E-4. A system is called fully permanent or stationary when all

lines and sprinklers are permanently located. Permanent systems usually have buried main and lateral lines to minimize interference with farming operations. Solid set systems are called fully portable when portable surface pipe is used for main and lateral lines. Portable solid set systems can be used in situations where the surface pipe will not interfere with farming operations and when it is desirable to remove the pipe from the field during periods of winter storage. When the mainline is permanently located and the lateral lines are portable surface pipe, the system is called semipermanent or alternatively semiportable.

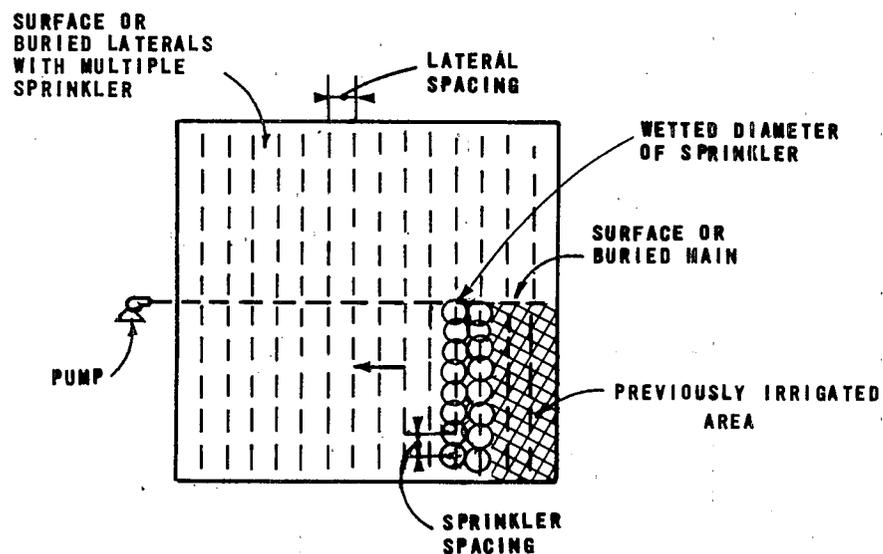

FIGURE E-4
SOLID SET SPRINKLER SYSTEM

The primary advantages of solid set systems are low labor requirements and maintenance costs, and adaptability to all types of terrain, field shapes, and crops. They are also the most adaptable systems for climate control requirements. The major disadvantages are high installation costs and obstruction of farming equipment by fixed risers.

E.4.2.1 Application Rate

For solid set systems, the application rate is expressed as a function of the sprinkler discharge capacity, the spacing

of the sprinklers along the lateral, and the spacing of the laterals along the main according to the following equation:

$$I = q_s C / S_s S_L \quad (E-7)$$

where I = application rate, cm/h (in./h)
 q_s = sprinkler discharge rate, L/s, (gal/min)
 C = constant = 360 (96.3)
 S_s = sprinkler spacing along lateral, m (ft)
 S_L = lateral spacing along main, m (ft)

Detailed procedures for sprinkler selection and spacing determination to achieve the desired application rate are given in references [6, 7, 8].

E.4.2.2 Sprinkler Selection and Spacing Determination

Sprinkler selection and spacing determination involves an iterative process. The usual procedure is to select a sprinkler and lateral spacing, then determine the sprinkler discharge capacity required to provide the design application rate at the selected spacing. The required sprinkler discharge capacity may be calculated using Equation E-7.

Manufacturers' sprinkler performance data are then reviewed to determine the nozzle sizes, operating pressures, and wetted diameters of sprinklers operating at the desired discharge rate. The wetted diameters are then checked with the assumed spacings for conformance with spacing criteria. Recommended spacings are based on a percentage of the wetted diameter and vary with the wind conditions. Recommended spacing criteria are given in Table E-6.

The sprinkler and nozzle size should be selected to operate within the pressure range recommended by the manufacturer. Operating pressures that are too low cause large drops which are concentrated in a ring a certain distance away from the sprinkler, whereas high pressures result in fine drops which fall near the sprinkler. Sprinklers with low design operating pressures are desirable from an energy conservation standpoint.

TABLE E-6
RECOMMENDED SPACING OF SPRINKLERS [6]

Average wind speed		
km/h	(mi/h)	Spacing, % of wetted diameter
0-11	(0-7)	40 (between sprinklers)
		65 (between laterals)
11-16	(7-10)	40 (between sprinklers)
		60 (between laterals)
>16	(>10)	30 (between sprinklers)
		50 (between laterals)

E.4.2.3 Lateral Design

Lateral design consists of selecting lateral sizes to deliver the total flow requirement of the lateral with friction losses limited to a predetermined amount. A general practice is to limit all hydraulic losses (static and dynamic) in a lateral to 20% of the operating pressure of the sprinklers. This will result in sprinkler discharge variations of about 10% along the lateral. Since flow is being discharged from a number of sprinklers, the effect of multiple outlets on friction loss in the lateral must be considered. A simplified approach is to multiply the friction loss in the entire lateral at full flow (discharge at the distal end) by a factor based on the number of outlets. The factors for selected numbers of outlets are presented in Table E-7. For long lateral lines, capital costs may be reduced by using two or more lateral sizes that will satisfy the headloss requirements.

The following guidelines should be used when laying out lateral lines:

1. Where possible, run the lateral lines across the predominant land slope and provide equal lateral lengths on both sides of the mainline.
2. Avoid running laterals uphill where possible. If this cannot be avoided, the lateral length must be shortened to allow for the loss in static head.
3. Lateral lines may be run down slopes from a mainline on a ridge, provided the slope is relatively uniform and not too steep. With this arrangement, static head is gained with distance

downhill, allowing longer or smaller lateral lines to be used compared to level ground systems.

4. Lateral lines should run as nearly as possible at right angles to the prevailing wind direction. This arrangement allows the sprinklers rather than laterals to be spaced more closely together to account for wind distortion and reduces the amount of pipe required.

TABLE E-7
FACTOR (F) BY WHICH PIPE FRICTION LOSS
IS MULTIPLIED TO OBTAIN ACTUAL LOSS IN
A LINE WITH MULTIPLE OUTLETS [3]

No. of outlets	Value of F
1	1.000
2	0.634
3	0.528
4	0.480
5	0.451
6	0.433
7	0.419
8	0.410
9	0.402
10	0.396
15	0.379
20	0.370
25	0.365
30	0.362
40	0.357
50	0.355
100	0.350

EXAMPLE E-3: DETERMINATION OF PRELIMINARY DESIGN CRITERIA
FOR SOLID SET SPRINKLER SYSTEM

Design Conditions

1. Soil conditions: loam, permeability - 0.75 cm/h
2. Crop: forage grass
3. Depth of water applied (D): 7.5 cm
4. Application zone area (A_a): 10 ha
5. Average wind speed: 8 km/h

Design Calculations

1. Determine design application rate (I). Assume 50% greater than bare soil permeability rate due to cover crop.

$$\text{Use } I = 1.13 \text{ cm/h (0.45 in./h)}$$

2. Select sprinkler and lateral spacings.

$$\text{Use } S_S = 12.2 \text{ m (40 ft)}$$

$$S_L = 18.3 \text{ m (60 ft)}$$

3. Calculate required sprinkler discharge using Equation E-7.

$$\begin{aligned} q_s &= \frac{(I)(S_S)(S_L)}{C} \\ &= \frac{(1.13 \text{ cm/h})(12.2 \text{ m})(18.3 \text{ m})}{360} \\ &= 0.7 \text{ L/s (11.1 gal/min)} \end{aligned}$$

4. Select sprinkler pressure and nozzle size from manufacturer's performance data to provide q_s .

$$\text{Use } 0.56 \text{ cm (7/32 in.) nozzle at } 48 \text{ N/cm}^2 \text{ (70 lb/in.}^2\text{)}.$$

$$\text{Wetted diameter} = 38.1 \text{ m (125 ft)}$$

5. Check selected spacing against spacing criteria in Table E-6.

$$\begin{aligned} \text{Sprinkler spacing} &= \frac{12.2}{38.1} (100\%) \\ &= 32\% \leq 40\% \end{aligned}$$

$$\begin{aligned} \text{Lateral spacing} &= \frac{18.3}{38.1} (100\%) \\ &= 48\% < 65\% \end{aligned}$$

6. Determine system flow capacity (Q)

$$Q = (A_a)(I)$$

$$= (10 \text{ ha})(1.13 \text{ cm/h})(10^4 \text{ m}^2/\text{ha})(10^{-2} \text{ m/cm})(0.28 \frac{\text{L/s}}{\text{m}^3/\text{h}})$$

$$= 314 \text{ L/s (4,975 gal/min)}$$

7. Determine application period.

$$t_a = D/I$$

$$= \frac{7.5 \text{ cm}}{1.13 \text{ cm/h}}$$

$$= 6.6 \text{ h}$$

E.4.3 Move-Stop Sprinkler Systems

With move-stop systems, sprinklers (or a single sprinkler) are operated at a fixed position in the field during application. After the desired amount of water has been applied, the system is turned off and the sprinklers (or sprinkler) are moved to another position in the field for the next application. Multiple sprinkler move-stop systems include portable hand-move systems, end tow systems, and side-wheel roll systems. Single sprinkler move-stop systems include stationary gun systems. The operational characteristics of these systems and a discussion of design procedures are described in the following paragraphs.

E.4.3.1 Portable Hand-Moved Systems

Portable hand-moved systems consist of a network of surface aluminum lateral pipes connected to a main line which may be portable or permanent. Lateral lines are constructed of aluminum pipe in 9 or 12 m (30 or 40 ft) lengths with sprinklers mounted on vertical risers extending from the lateral at equal intervals. There are not enough lateral lines to cover the entire field; thus, lateral lines must be hand-moved between applications to different positions along the main to apply water to the entire field. A schematic of a portable hand moved system is shown in Figure E-5a. The major advantages of portable systems include low capital costs and adaptability to most field conditions and climates. They may also be removed from the fields to avoid interference with farm machinery. The principal disadvantage is the high labor requirement to operate the system.

E.4.3.2 End Tow Systems

End tow systems are multiple-sprinkler laterals mounted on skids or wheel assemblies to allow a tractor to pull the lateral intact from one position along the main to the next. As indicated in Figure E-5b, the lateral is guided by capstans to control its alignment. The pipe and sprinkler design considerations are identical to those for portable pipe systems with the exception that pipe joints are stronger than hand moved systems to accommodate the pulling requirements.

The primary advantages of an end tow system are lower labor requirements than hand moved systems, relatively low system costs, and the capability to be readily removed from the field to allow farm implements to operate. Disadvantages include crop restrictions to movement of laterals and cautious operation to avoid crop and equipment damage.

E.4.3.3 Side Wheel Roll

Side wheel roll or wheel move systems are basically lateral lines of sprinklers suspended on a series of wheels. The lateral line is aluminum pipe, typically 10.2 to 12.7 cm (4 to 5 in.) in diameter and up to 403 m (1,320 ft) long. The wheels are aluminum and are 1.5 to 2.1 m (5 to 7 ft) in diameter (see Figure E-6). The end of the lateral is connected by flexible hose to hydrants located along the main line. The unit is stationary during application and is moved between applications by an integral engine powered drive unit located at the center of the lateral (see Figure E-5c). The drive unit is controlled by an operator.

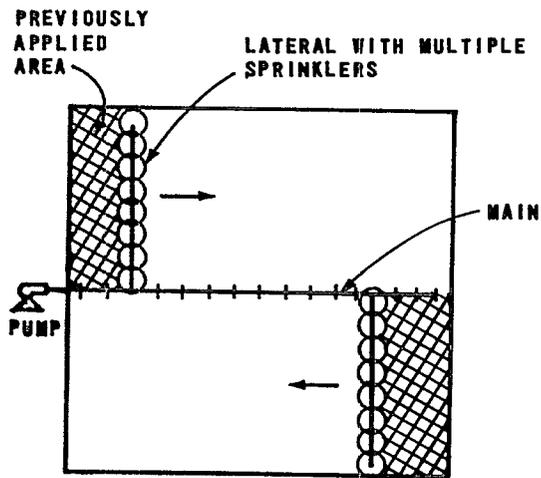

(a) PORTABLE HAND MOVED

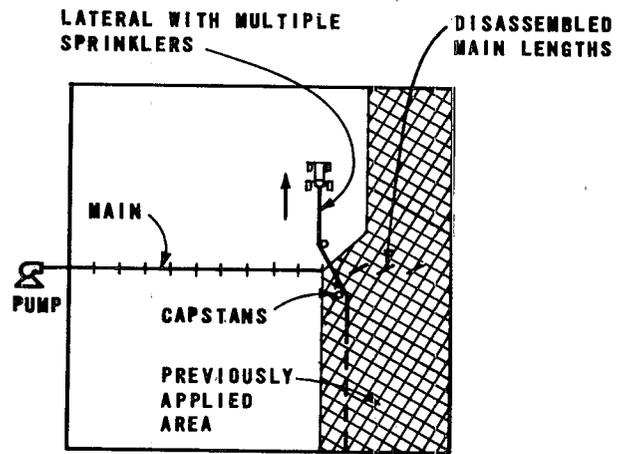

(b) END TOW

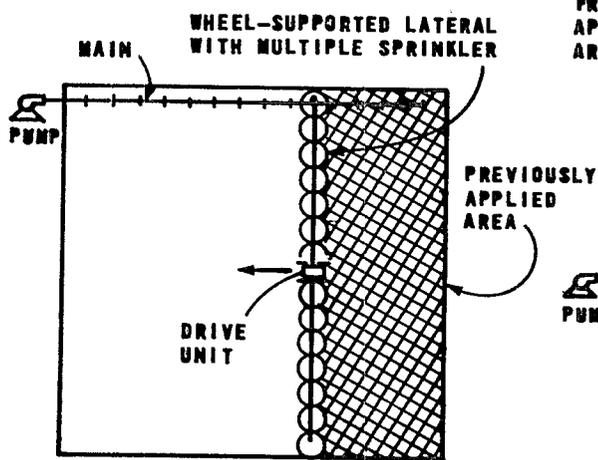

(c) SIDE WHEEL ROLL

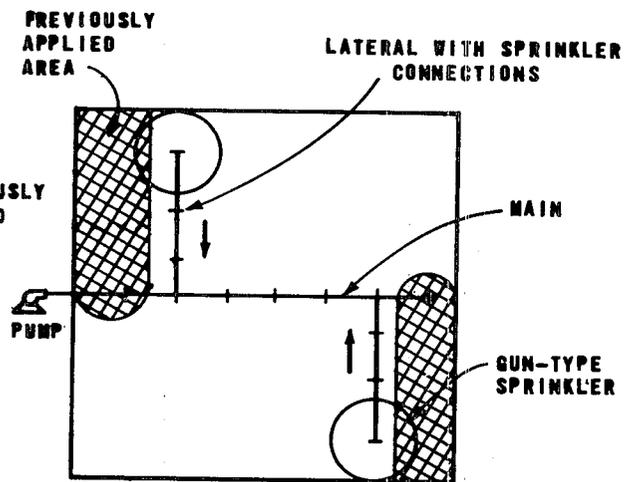

(d) STATIONARY GUN

**FIGURE E-5
MOVE-STOP SPRINKLER SYSTEMS**

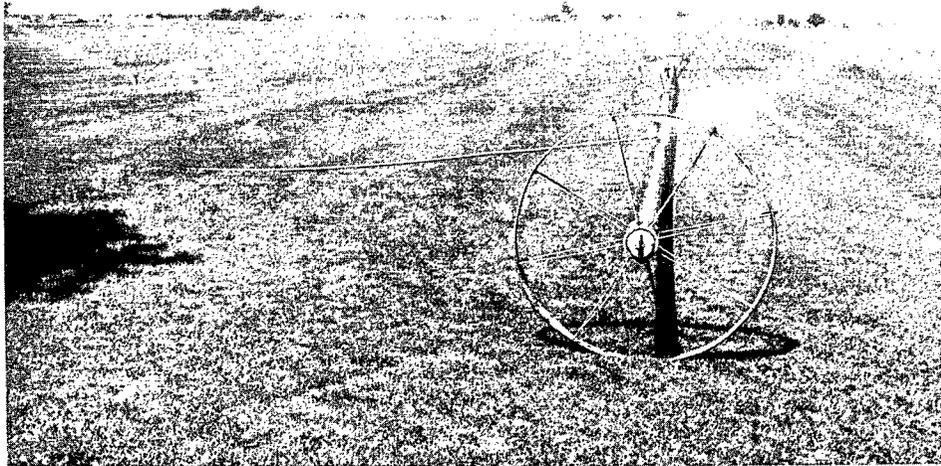

FIGURE E-6
SIDE WHEEL ROLL SPRINKLER SYSTEM

The sprinklers are mounted on swivel connections to ensure upright positions at all times. Sprinkler spacings are typically 9.2 to 12.5 m (30 or 40 ft) and wheel spacings may range from 9.2 to 30.5 m (30 to 100 ft). Side wheel laterals may be equipped with trail lines up to 27 m (90 ft) in length located at each sprinkler connection on the axle lateral. Each trail line has sprinklers mounted on risers spaced typically at 9 to 12 m (30 to 40 ft). Use of trail lines allows a larger area to be covered by a single unit, which reduces either the number of moves or the number of units required to cover a given field.

The principal advantages of side wheel roll systems are relatively low labor requirements and overall costs, and freedom from interference with farm implements. Disadvantages include restrictions to crop height and field shape, and misalignment of the lateral caused by uneven terrain.

E.4.3.4 Stationary Gun Systems

Stationary gun systems are wheel-mounted or skid-mounted single sprinkler units, which are moved manually between hydrants located along the laterals (see Figure E-5d). Since the sprinkler operates at greater pressures and flowrates than multiple sprinkler systems, the irrigation time is usually shorter. After an application has been completed for the lateral, the entire lateral is moved to the next point along the main. In some cases, a number of laterals and sprinklers may be provided to minimize movement of laterals.

The advantages of a stationary gun are similar to those of portable pipe systems with respect to capital costs and versatility. In addition, the larger nozzle of the gun-type sprinkler is relatively free from clogging. The drawbacks to this system are similar to those for portable pipe systems in that labor requirements are high due to frequent sprinkler moves. Power requirements are relatively high due to high pressures at the nozzle, and windy conditions adversely affect distribution of the fine droplets created by the higher pressures.

E.4.3.5 Design Procedures

The design procedures regarding application rate, sprinkler selection, sprinkler and lateral spacing, and lateral design for move-stop systems are basically the same as those described for solid set sprinkler systems. An additional design variable for move-stop systems is the number of units required to cover a given area. The minimum required number of units is a function of the area covered by each unit, the application frequency, and the period of application. More than the minimum number of units can be provided to reduce the number of moves required to cover a given area. The decision to provide additional units must be based on the relative costs of equipment and labor.

E.4.4 Continuous Move Systems

Continuous move sprinkler systems are self-propelled and move continuously during the application period. The three types of continuous move systems are (1) traveling gun, (2) center pivot, and (3) linear move. Schematics of the systems are shown in Figure E-7.

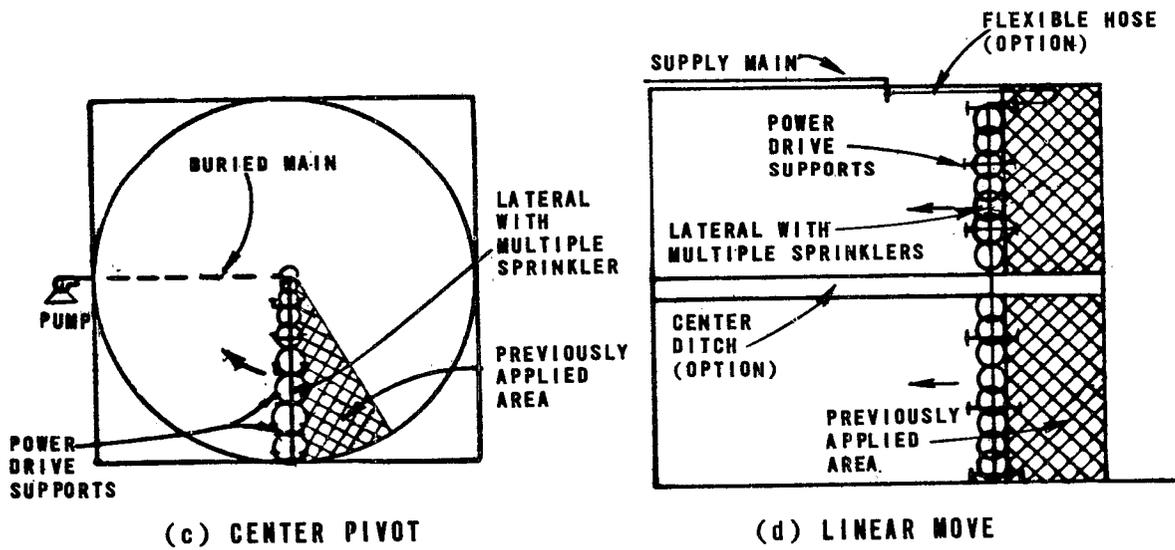
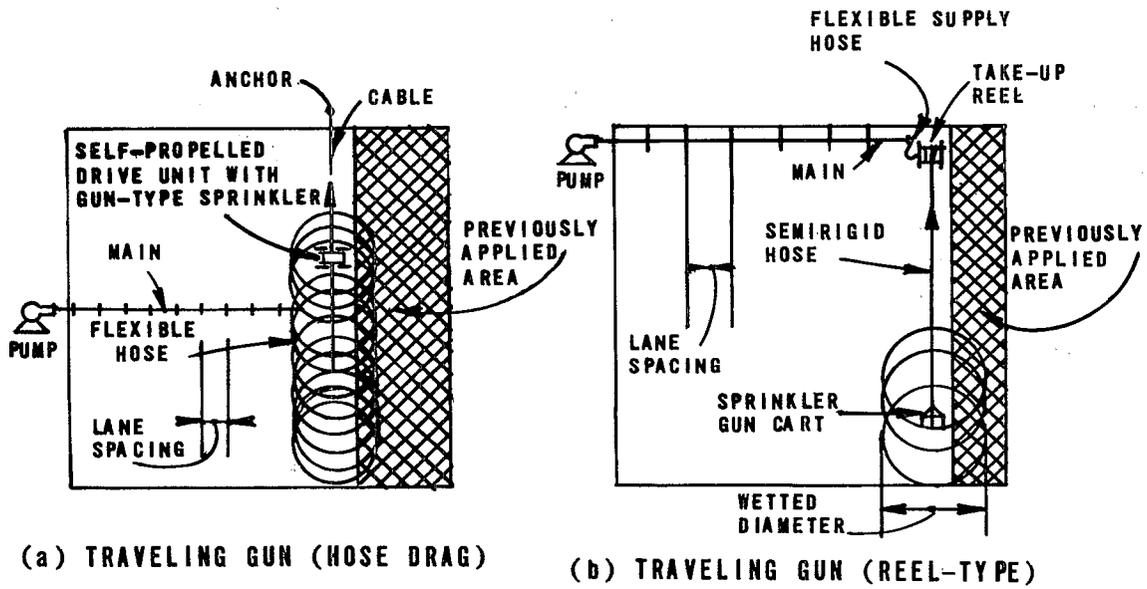

FIGURE E-7
CONTINUOUS MOVE SPRINKLER SYSTEMS

E.4.4.1 Traveling Gun Systems

Traveling gun systems are self-propelled, single large gun sprinkler units that are connected to the supply source by a hose 6.4 to 12.7 cm (2.5 to 5 in.) in diameter. Two types of travelers are available, the hose drag-type and the reel-type. The hose drag traveler is driven by a hydraulic or gas-driven winch located within the unit, or a gas-driven winch located at the end of the run (see Figure E-8). In both cases, a cable anchored at the end of the run guides the unit in a straight path during the application. The flexible rubber hose is dragged behind the unit. The reel-type traveler consists of a sprinkler gun cart attached to a take-up reel by a semirigid polyethylene hose. The gun is pulled toward the take-up reel as the hose is slowly wound around the hydraulic powered reel. Variable speed drives are used to control travel speeds. Typical lengths of run range between 201 and 403 m (660 and 1,320 ft), and spacings between travel lanes range between 50 and 100 m (165 and 330 ft). After application on a lane is complete, the unit shuts off automatically. Some units also shut off the water supply automatically. The unit must be moved by tractor to the beginning of the next lane.

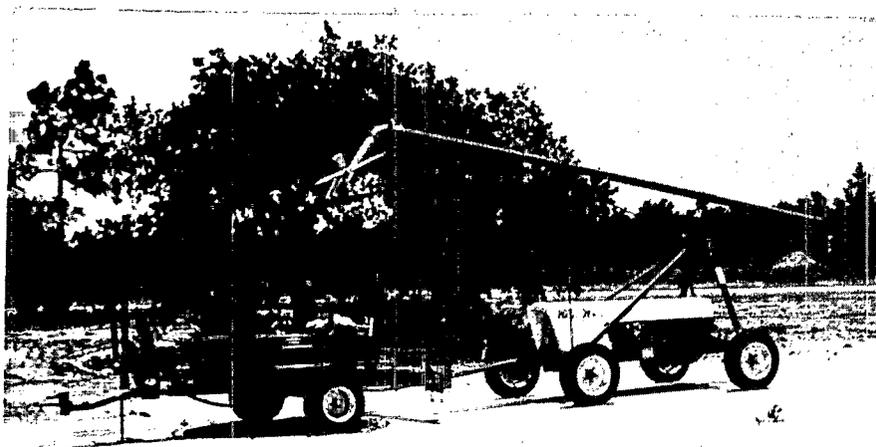

FIGURE E-8
HOSE-DRAG TRAVELING GUN SPRINKLER

The more important advantages of a traveling gun system are low labor requirements and relatively clog-free nozzles. They may also be adapted to fields of somewhat irregular shape and topography. Disadvantages are high power requirements, hose travel lanes required for hose drag units for most crops, and drifting of sprays in windy conditions.

In addition to the application rate and depth of application, the principal design parameters for traveling guns are the sprinkler capacity, spacing between travel lanes, and the travel speed.

The minimum application rate of most traveling gun sprinklers is about 0.6 cm/h (0.23 in./h), which is higher than the infiltration rate of the less permeable soils. Therefore, the use of traveling guns on soils of low permeability without a mature cover crop is not recommended. The relationship between sprinkler capacity, lane spacing, travel speed, and depth of application is given by the following equation:

$$D = \frac{q_s C}{(S_t)(S_p)} \quad (E-8)$$

where D = depth of water applied, cm (in.)
q_s = sprinkler capacity, L/s (gal/min)
S_t = space between travel lanes, m (ft)
S_p = travel speed, m/min (ft/min)
C = conversion constant, 6.01 (1.60)

The usual design procedure is as follows:

1. Select a convenient application period (usually about 11 or 23 hours) to allow time (about 1 hour) for moves between applications.
2. Measure the longest travel lane length (403 m or 1,320 ft maximum for hose drag; 360 m or 1,180 ft maximum for reel-type) based on site boundaries.
3. Calculate the travel speed necessary to travel the longest travel lane in the desired application period.

4. Select a sprinkler and sprinkler operating pressure from manufacturers' performance tables with wetted diameters compatible with site boundaries and with application rates suitable for soil conditions. Sprinkler operating pressures should be above 55 N/cm^2 (80 lb/in.^2).
5. Compute the required lane spacing to provide the desired depth of water application using Equation E-8.
6. Check lane spacing against spacing criteria in Table E-8.

TABLE E-8
RECOMMENDED MAXIMUM LANE SPACING
FOR TRAVELING GUN SPRINKLERS

Wind speed		Lane spacing, % of wetted diameter
km/h	(mi/h)	
0	(0)	80
0-8	(0-5)	70-75
0-16	(0-10)	60-65
>16	(>10)	50-55

7. Adjust sprinkler selection and lane spacing as necessary to meet spacing criteria.
8. Select a hose size for the unit such that friction loss of the design sprinkler flow capacity does not exceed 28 N/cm^2 (40 lb/in.^2).
9. Determine the total area covered by a single unit

$$\text{Unit area, m}^2 = (S_t)(\text{avg travel distance per day}) \\ \times (\text{days between application})$$

10. Determine total number of units required

$$\text{Units required} = \frac{(\text{field area, m}^2)}{\times (\text{unit area, m}^2)}$$

11. Determine the system supply capacity (Q)

$$Q = (q_s)(\text{No. of units})$$

E.4.4.2 Center Pivot Systems

Center pivot systems consist of a lateral with multiple sprinklers or spray nozzles that is mounted on self-propelled, continuously moving tower units (see Figure E-9) rotating about a fixed pivot in the center of the field. Sprinklers on the lateral may be high pressure impact sprinklers; however, the trend is toward use of low pressure spray nozzles to reduce energy requirements. Water is supplied by a well or a buried main to the pivot, where power is also furnished. The lateral is usually constructed of 15 to 20 cm (6 to 8 in.) steel pipe 61 to 793 m (200 to 2,600 ft) in length. A typical system with a 393 m (1,288 ft) lateral covers a 64 ha (160 acre) parcel (see Figure E-10). The circular pattern reduces coverage to about 52 ha (130 acres), although systems with traveling end sprinklers are available to irrigate the corners.

The tower units are driven electrically or hydraulically and may be spaced from 24 to 76 m (80 to 250 ft) apart. The lateral is supported between the towers by cables or trusses. Control of the travel speed is achieved by varying the running time of the tower motors.

An important limitation of the center pivot system is the required variation in sprinkler application rates along the length of the pivot lateral. Because the area circumscribed by a given length of pivot lateral increases with distance from the pivot point (as does the ground speed of the unit), the application rate provided by the sprinklers along the lateral must increase with distance from the center to provide a uniform depth of application. Increasing the application rates can be accomplished by decreasing the spacing of the sprinklers along the lateral and increasing the sprinkler discharge capacity. The resulting application rates at the outer end of the pivot lateral can be unacceptable for many soils.

Application rates approaching 2.5 cm/h (1.0 in./h) may be necessary at a distance of 400 m (1,300 ft). The designer should be particularly aware of this limitation at sites where soil permeabilities vary within the pivot circle. Areas of slower permeability can be flooded, causing crop damage and traction problems for the drive wheels. This particular problem has been encountered at the Muskegon project. Determination of the proper sprinkler spacings and capacities for a center pivot rig is beyond the scope of this manual. The designer should consult the manufacturer for design details.

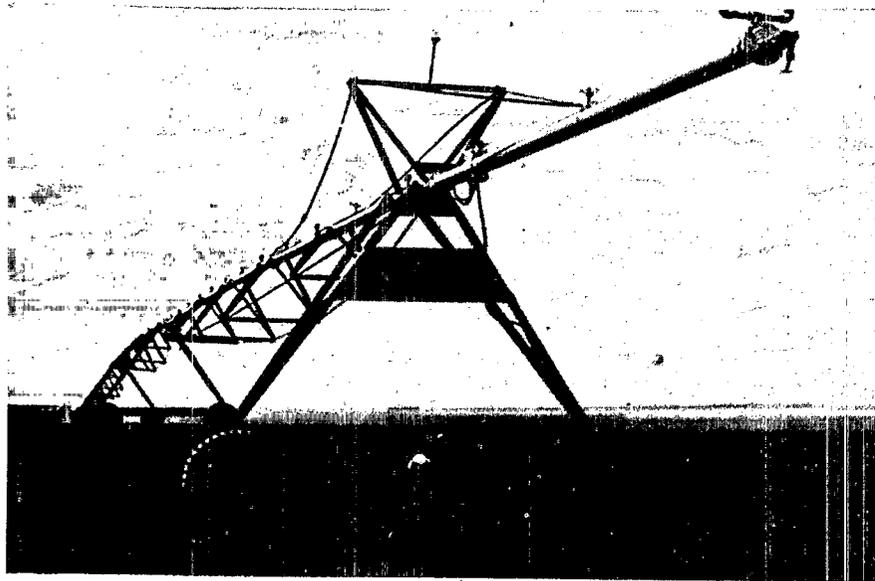

**FIGURE E-9
CENTER PIVOT RIG**

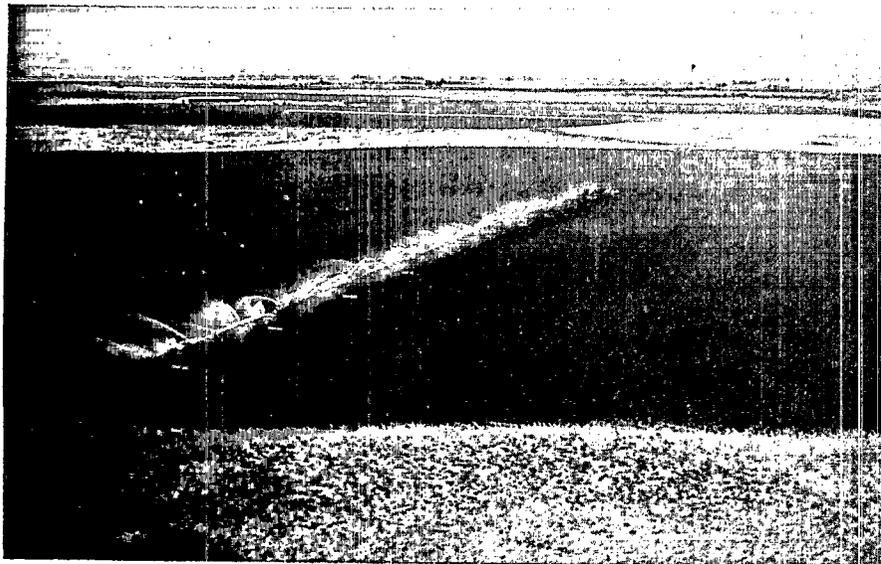

**FIGURE E-10
CENTER PIVOT IRRIGATION SYSTEM**

Another limitation of center pivots is mobility under certain soil conditions. Some clay soils can build up on wheels and eventually cause the unit to stop. Drive wheels can lose traction on slick (silty) soils and can sink into soft soils and become stuck.

E.4.4.3 Linear Move Systems

Linear move systems are constructed and driven in a similar manner to center pivot systems, except that the unit moves continuously in a linear path rather than a circular path. Complete coverage of rectangular fields can thus be achieved while retaining all the advantages of a continuous move system. Water can be supplied to the unit through a flexible hose that is pulled along with the unit or it can be pumped from an open center ditch constructed down the length of the linear path. Slopes greater than 5% restrict the use of center ditches. Manufacturers should be consulted for design details.

E.5 References

1. Booher, L.J. Surface Irrigation. FAO Agricultural Development Paper No. 94. Food and Agricultural Organization of the United Nations. Rome. 1974.
2. Merriam, J.L. and J. Keller. Irrigation System Evaluation: A Guide for Management. Utah State University, Logan, Utah. 1978.
3. McCulloch, A.W. et al. Lockwood-Ames Irrigation Handbook. W.R. Ames Company, Gering, Nebraska. 1973.
4. Hart, W.E. Irrigation System Design. Colorado State University, Department of Agricultural Engineering. Fort Collins, Colorado. November 10, 1975.
5. Border Irrigation. Irrigation, Chapter 4. SCS National Engineering Handbook, Section 15. U.S. Department of Agriculture, Soil Conservation Service. August 1974.
6. Fry, A.W. and A.S. Gray. Sprinkler Irrigation Handbook. Rain Bird Sprinkler Manufacturing Corporation, Glendora, California. 10th edition. 1971.
7. Sprinkler Irrigation. Irrigation, Chapter 11. SCS National Engineering Handbook, Section 15. U.S. Department of Agriculture, Soil Conservation Service. July 1968.

8. Pair, C.H. et al., eds. Sprinkler Irrigation, Fourth Edition. Sprinkler Irrigation Association. Silver Spring, Maryland. 1975.

APPENDIX F
ESTIMATED STORAGE DAYS FOR LAND TREATMENT
USING EPA COMPUTER PROGRAMS

Computer programs have been developed to estimate storage days for land treatment systems based on climatic conditions (Section 4.6.2). Selected locations for which the EPA-1 program have been used are presented in Table F-1 for recurrence intervals of 10 and 20 years. The EPA-2 program (for SR systems) uses soil information as well as rainfall (see reference 35 in Chapter 4 for details). The EPA-3 program (for SR or OF systems) uses temperature, rainfall, and snow depth. Storage days for communities for which EPA-2 has been run are listed in Table F-2 for recurrence intervals of 10 and 20 years. Storage days for communities for which EPA-3 has been run are listed in Table F-3 for recurrence intervals of 10 and 20 years.

TABLE F-1
STORAGE DAYS USING EPA-1 FOR 20 YEAR (5%)
AND 10 YEAR (10%) RETURN INTERVALS

Station Name	State	Percentiles		Station Name	State	Percentiles	
		0.05	0.10			0.05	0.10
Bridgeport	CT	68	64	Bismarck	ND	144	140
Boise	ID	87	77	Devils Lake	ND	168	156
Pocatello	ID	125	109	Burns	OR	119	102
Des Moines	IA	111	106	Aberdeen	SD	142	138
Hampton	IA	136	126	Brookings	SD	136	131
Logan	IA	107	105	Pierre	SD	136	126
Shenandoah	IA	95	77	Rapid City	SD	100	99
Greenville	ME	172	169	Burlington	VT	136	134
Muskegon	MI	119	116	Spokane	WA	106	100
International Falls	MN	172	168	Ashland	WI	149	148
Minneapolis	MN	143	143	Eau Claire	WI	147	141
Park Rapids	MN	159	155	Green Bay	WI	139	135
Billings	MT	102	100	Lacrosse	WI	134	127
Bozeman	MT	152	144	Madison	WI	125	119
Great Falls	MT	102	91	Rhineland	WI	156	149
Missoula	MT	128	121	Weyerhauser	WI	148	145
Buffalo	NY	108	103	Afton	WY	156	144
Rochester	NY	121	115	Casper	WY	101	95
Watertown	NY	128	126	Gillette	WY	113	108
				Ruck Springs	WY	142	136
				Wheatland	WY	66	58

TABLE F-2
STORAGE DAYS USING EPA-2 FOR 20 YEAR (5%)
AND 10 YEAR (10%) RETURN INTERVALS^a

Station name	State	Percentiles		Station name	State	Percentiles	
		0.05	0.10			0.05	0.10
Bay Minette	AL	13	13	Wilmington	NC	10	9
Brewton	AL	16	11	Wilson	NC	12	11
Clanton	AL	20	11	Eugene	OR	34	31
Mobile	AL	14	11	Forest Grove	OR	134	129
Selma	AL	18	11	Headworks	OR	150	144
Thomasville	AL	23	13	Hillsboro	OR	119	111
Dumas	AR	19	14	Medford	OR	19	11
Little Rock	AR	12	12	Portland	OR	126	110
Avon Park	FL	12	9	Salem	OR	34	25
Belle Glade	FL	10	8	Arecibo	PR	11	10
Bradenton	FL	13	12	Coloso	PR	17	13
Clermont	FL	11	7	Guayama	PR	24	16
Daytona Beach	FL	8	8	Humacao	PR	25	19
Orlando	FL	11	9	San Juan	PR	7	6
Punta Gorda	FL	16	11	Columbia	SC	13	8
Tampa	FL	30	17	Conway	SC	9	9
Augusta	GA	10	9	Darlington	SC	11	9
Macon	GA	11	9	Hampton	SC	10	8
Newnan	GA	15	10	Summerville	SC	16	8
Savannah	GA	16	11	Bristol	TN	23	19
Alexandria	LA	19	14	Crossville	TN	24	22
Franklinton	LA	16	15	Brownsville	TX	11	6
Houma	LA	16	11	Corpus Christi	TX	11	5
Lafayette	LA	12	10	Dallas	TX	15	12
Lake Providence	LA	18	14	Houston	TX	36	26
Leesville	LA	31	16	Luling	TX	40	36
Monroe	LA	12	12	Mexia	TX	42	35
New Orleans	LA	16	9	Paris	TX	16	11
Schriever	LA	15	13	Port Isabel	TX	10	9
Shreveport	LA	10	8	Sealy	TX	32	26
St Joseph	LA	11	11	Sugar Land	TX	77	51
Winnfield	LA	15	14	Blackstone	VA	21	16
Aberdeen	MS	23	13	Buchanan	VA	31	19
Biloxi	MS	13	10	Chatham	VA	21	19
Canton	MS	15	11	Columbia	VA	23	21
Clarksdale	MS	16	11	Diamond Springs	VA	15	11
Columbia	MS	27	16	Leesville	VA	31	16
Greenwood	MS	15	12	Lynchburg	VA	23	18
Jackson	MS	12	10	Norfolk	VA	17	14
Meridian	MS	13	11	Richmond	VA	15	14
Pontotoc	MS	19	14	Washington DC	VA	22	19
Poplarville	MS	22	13	Aberdeen	WA	213	181
Stoneville	MS	17	15	Longview	WA	53	35
Vicksburg	MS	27	23	Olympia	WA	58	38
Charlotte	NC	12	11	Seattle	WA	40	24
Pinehurst	NC	12	9	Vancouver	WA	28	19
Raleigh	NC	13	12				
Weldon	NC	11	10				

a. Available water capacity range from 15 to 30 cm (6 to 12 in.) in top 1.5 m (5 ft) of soil profile. Depletion rate usually set at 1.9 cm/d (0.75 in./d)

TABLE F-3
STORAGE DAYS USING EPA-3 FOR 20 YEAR (5%)
AND 10 YEAR (10%) RETURN INTERVALS^a

Station Name	State	Percentiles		Station Name	State	Percentiles	
		0.05	0.01			0.05	0.10
Sterling	CO	118	110	Chestertown	MD	73	46
Belle Plaine	IA	133	128	Westminster	MD	86	82
Des Moines	IA	135	128	Freehold	NJ	88	77
Grinnell	IA	139	133	Pemberton	NJ	80	72
Indianola	IA	122	113	Santa Fe	NM	98	88
Keosauqua	IA	111	91	Minden ^c	NV	69	63
Logan	IA	126	114	Reno	NV	61	57
Newton	IA	134	126	Rochester	NY	123	122
Osceola	IA	122	118	Coatesville	PA	89	85
Oskaloosa	IA	130	121	George School	PA	87	83
Shenandoah	IA	114	101	Lancaster	PA	86	84
Winterset	IA	134	127	Philadelphia	PA	80	66
Ashton	ID	151	148	York	PA	85	80
Ottawa	IL	115	89	Corsicana ^d	TX	8	6
Plymouth	MA	95	91	Alta	WY	172	160
Baltimore	MD	77	57	Diversion Dam	WY	140	137
Beltsville ^b	MD	76	58	Lander	WY	146	139
Blackwater Refuge	MD	35	29	Pavillion	WY	140	137
				Riverton	WY	150	144

- a. Temperature thresholds: mean 0 °C (32 °F); minimum -4 °C (25 °F); maximum 4.4 °C (40 °F)
Precipitation thresholds: snow 2.54 cm (1 in.); Precipitation 1.27 cm (0.5 in.).
Drawdown rate: ratio of flow output from storage on favorable days to average daily wastewater flow = 0.5.
- b. Temperature thresholds: minimum -5.5 °C (22 °F); maximum 1.7 °C (35 °F).
c. Temperature thresholds: minimum -6.7 °C (20 °F); maximum 1.7 °C (35 °F).
d. Temperature thresholds: minimum -2.2 °C (28 °F); maximum 2.2 °C (36 °F).

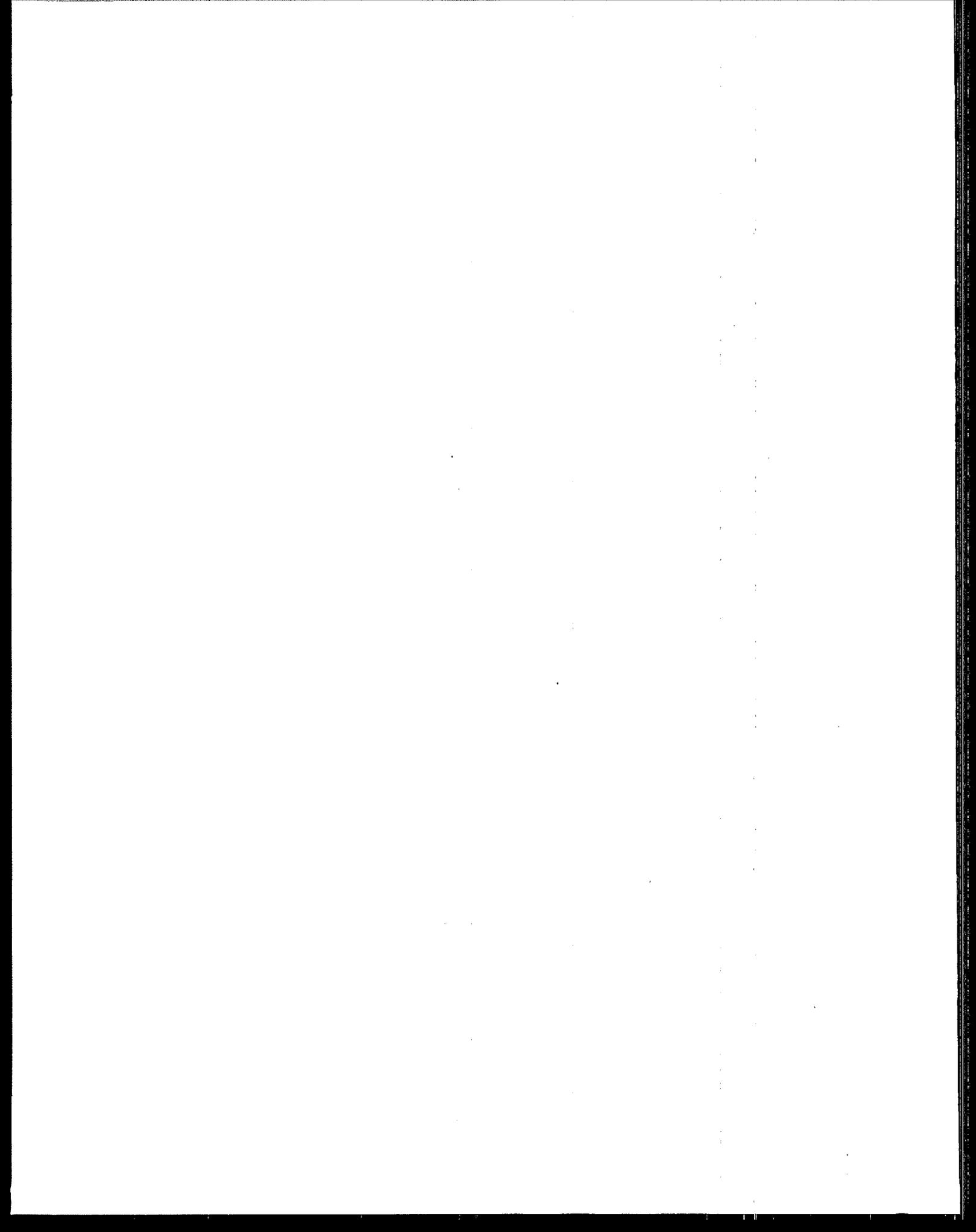

APPENDIX G
GLOSSARY OF TERMS
CONVERSION FACTORS

GLOSSARY OF TERMS

acre-foot--A liquid measure of a volume equal to covering a 1 acre area to 1 foot of depth.

aerosol--A suspension of colloidal solid or liquid particles in air or gas, having small diameters ranging from 0.01 to 50 microns.

aquiclude--A geologic formation which, although porous and capable of absorbing water slowly, will not transmit it rapidly enough to furnish an appreciable supply for a well or spring.

available moisture--The part of the water in the soil that can be taken up by plants at rates significant to their growth; the moisture content of the soil in excess of the ultimate wilting point.

coppice--sprouting from tree stumps.

cultivar--A cultural variety of a plant species.

evapotranspiration--The combined loss of water from a given area and during a specified period of time, by evaporation from the soil surface, snow, or intercepted precipitation, and by the transpiration and building of tissue by plants.

field area--The "wetted area" where treatment occurs in a land application system.

field capacity--(field moisture capacity)--The moisture content of soil in the field 2 or 3 days after having been saturated and after free drainage has practically ceased; the quantity of water held in a soil by capillary action after the gravitational or free water has been allowed to drain; expressed as moisture percentage, dry weight basis.

fragipan--A loamy, dense, brittle subsurface horizon that is very low in organic matter and clay but is rich in silt or very fine sand. The layer is seemingly cemented and slowly or very slowly permeable.

horizon (soil)--A layer of soil, approximately parallel to the soil surface, with distinct characteristics produced by soil-forming processes.

infiltrometer--A device by which the rate and amount of water infiltration into the soil is determined (cylinder, sprinkler, or basin flooding).

matric potential--Attractive forces of soil particles for water and water molecules for each other.

micronutrient--A chemical element necessary in only small trace amounts (less than 1 mg/L) for microorganisms and plant growth. Essential micronutrients are boron, chloride, copper, iron, manganese, molybdenum, and zinc.

mineralization--The conversion of a compound from an organic form to an inorganic form as a result of microbial decomposition.

sodic soil--A soil that contains sufficient sodium to interfere with the growth of most crop plants, and in which the exchangeable sodium percentage is 15 or more.

soil water--That water present in the soil pores in an unsaturated (aeration) zone above the ground water table. Such water may either be lost by evapotranspiration or percolation to the ground water table.

tensiometer--A device used to measure the negative pressure (or tension) with which water is held in the soil; a porous, permeable ceramic cup connected through a tube to a manometer or vacuum gage.

till--Deposits of glacial drift laid down in place as the glacier melts, consisting of a heterogeneous mass of rock flour, clay, sand, pebbles, cobbles, and boulders intermingled in any proportion; the agricultural cultivation of fields.

tilth--The physical condition of a soil as related to its ease of cultivation. Good tilth is associated with high noncapillary porosity and stable, granular structure, and low impedance to seedling emergence and root penetration.

transpiration--The net quantity of water absorbed through plant roots that is used directly in building plant tissue, or given off to the atmosphere as a vapor from the leaves and stems of living plants.

volatilization--The evaporation or changing of a substance from liquid to vapor.

wilting point--The minimum quantity of water in a given soil necessary to maintain plant growth. When the quantity of moisture falls below this, the leaves begin to drop and shrivel up.

CONVERSION FACTORS
Metric to U.S. Customary

Metric		U.S. customary unit		
Name	Symbol	Multiplier	Abbreviation	Name
centimeter(s)	cm	0.3937	in.	inches
centimeter(s) per hour	cm/h	0.3937	in./h	inches per hour
cubic meter	m ³	8.1071 x 10 ⁻⁴	acre-ft	acre-foot
		35.3147	ft ³	cubic foot
		264.25	Mgal	million gallons
cubic meters per day	m ³ /d	2.6417 x 10 ⁻⁴	Mgal/d	million gallons per day
cubic meters per hectare	m ³ /ha	1.069 x 10 ⁻⁴	Mgal/acre	million gallons per acre
cubic meters per second	m ³ /s	22.82	Mgal/d	million gallons per day
degrees Celsius	°C	1.8(°C) + 32	*F	degrees Fahrenheit
gram(s)	g	0.0022	lb	pound(s)
hectare	ha	2.4711	acre	acre
		0.004	mi ²	square miles
Joule	J	9.48 x 10 ⁻⁴	Btu	British thermal unit
kilogram(s)	kg	2.205	lb	pound(s)
kilograms per hectare	kg/ha	0.0004	tons/acre	tons per acre
kilograms per hectare per day	kg/ha·d	0.893	lb/acre·d	pounds per acre per day
kilograms per square centimeter	kg/cm ²	14.49	lb/in. ²	pounds per square inch
kilometer	km	0.6214	mi	mile
kilowatt	kW	1.34	hp	horsepower
liter	L	0.0353	ft ³	cubic foot
		0.264	gal	gallon(s)
liters per hectare per day	L/ha·d	0.11	gal/acre·d	gallons per acre per day
liters per second	L/s	0.035	ft ³ /s	cubic feet per second
		22.826	gal/d	gallons per day
		15.85	gal/min	gallons per minute
		0.023	Mgal/d	million gallons per day
megagram (metric tonne)	Mg (or t)	1.10	ton (short)	ton (short)
megagrams per hectare	mg/ha	0.446	tons/acre	tons per acre
megajoule	MJ	0.278	kWh	kilowatt hour
megaliters (liters x 10 ⁶)	ML	0.264	Mgal	million gallons
meters(s)	m	3.2808	ft	foot (feet)
meters per second	m/s	2.237	mi/h	miles per hour
micrograms per liter	µg/L	1.0	ppb	parts per billion
milligrams per liter	mg/L	1.0	ppm	parts per million
nanograms per liter	ng/L	1.0	ppt	parts per trillion
Newton's per square centimeter	N/cm ²	1.45	lb/in. ²	pounds per square inch
square centimeter	cm ²	0.155	in. ²	square inch
square kilometer	km ²	0.386	mi ²	square mile
square meter	m ²	10.76	ft ²	square foot

